



Greenleaf's Global Support Center is the most comprehensive online source for purchasing Greenleaf cutting tools and components. There are over 15,000 items from which to choose. In addition, you have immediate access to the technical information you need to run Greenleaf's advanced cutting tool products to their fullest potential.

**Greenleaf Corporation**  
18695 Greenleaf Drive  
Saegertown, PA 16433 USA  
800-458-1850 | 814-763-2915  
sales@greenleafcorporation.com

**Greenleaf Europe B.V.**  
Schimmert, The Netherlands  
+31-45-404-1774  
eurooffice@greenleafcorporation.com

**Greenleaf (Hunan) High-Tech Materials Co., Ltd.**  
Changsha, Hunan 410205, China  
+86-731-89954796  
info@greenleafcorporation.com.cn

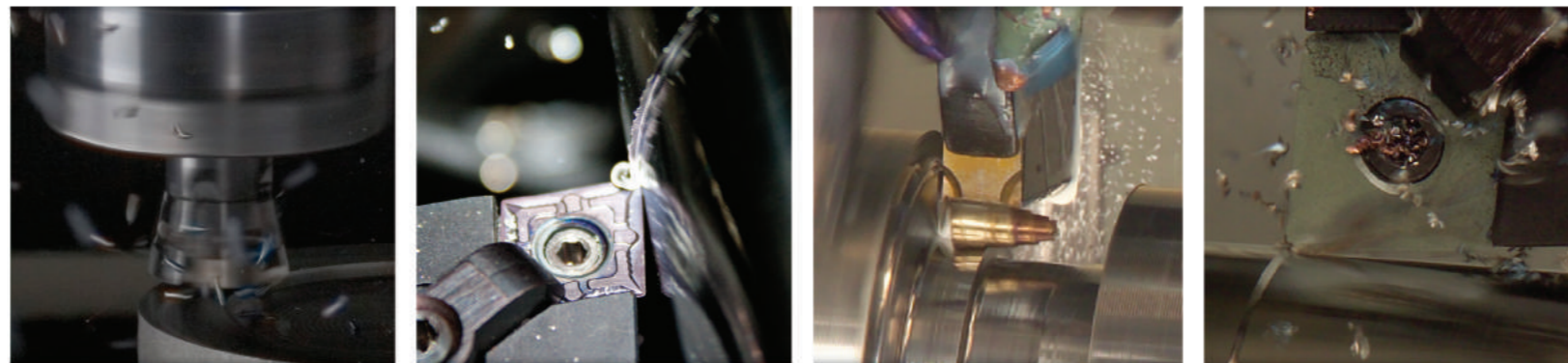

## PRODUCTGUIDE METALCUTTING TOOLS AND SYSTEMS



**Greenleaf Corporation** is a leading developer of cutting-tool technology. We specialize in the manufacture of high-performance tungsten carbide and ceramic inserts as well as innovative tool-holding systems. **Greenleaf continues to build on over 70 years of innovation.** We center on supplying customers with productive solutions to every metalcutting need.

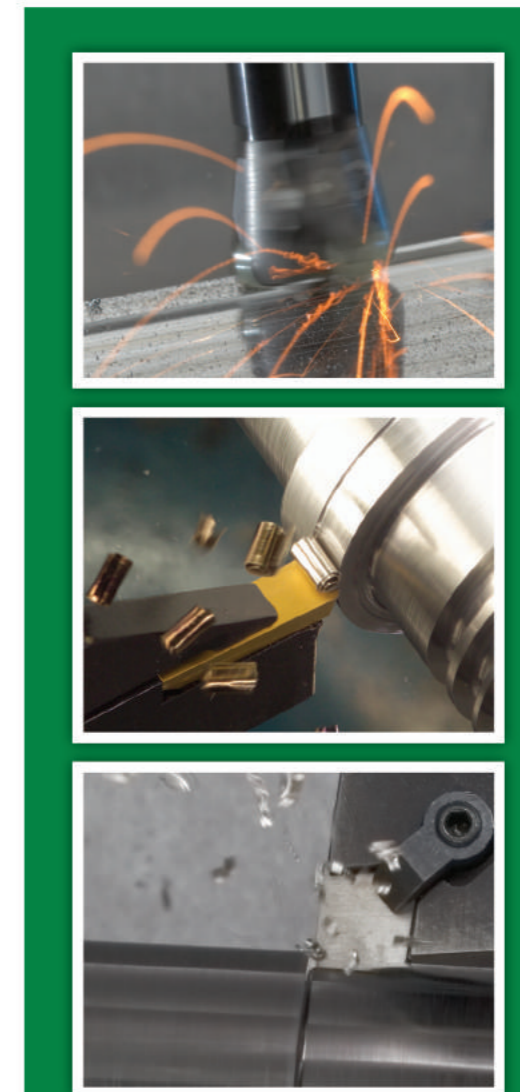

### WG-300® / WG-600® / WG-700™ The world's most productive whisker-reinforced ceramic inserts.

**WG-300®** is extremely successful at machining hard materials such as hard steels and nickel- and cobalt-based super alloys. It offers excellent wear and shock resistance at high surface speeds.

**WG-600®** has the advantage of offering 2-3 times longer tool life over uncoated whiskered ceramics. WG-600® excels at machining high-strength alloy materials, hardened steels and other difficult-to-cut materials.

**WG-700™** is ideal for machining nickel- and cobalt-based super alloys and other difficult-to-machine materials. WG-700™ is capable of greater feed rates and higher speed machining than any other whisker grade with exceptional tool life.



Coated Whisker-Reinforced Ceramic Inserts U.S. Patent No. 6,447,896 B1



# Ceramic Inserts

Greenleaf is the industry leader in the development and manufacture of ceramic and coated ceramic inserts in ANSI standard and special geometries.



## WG-300®

- Whisker-reinforced Al<sub>2</sub>O<sub>3</sub> ceramic for machining nickel- and cobalt-based super alloys and hard steels
- Excellent thermal and shock resistance at very high surface speeds
- First choice worldwide for milling, grooving and turning difficult-to-cut, non-ferrous materials



## WG-600®

- Coated whisker-reinforced Al<sub>2</sub>O<sub>3</sub> ceramic for machining nickel and cobalt-based super alloys and hard steels
- Excellent thermal and wear resistance at very high surface speeds
- Extended tool life over uncoated whisker-reinforced ceramics  
*U.S. Patent No. 6,447,896 B1*

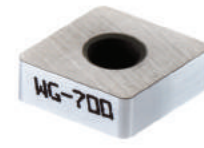

## WG-700™

- New coated whisker-reinforced Al<sub>2</sub>O<sub>3</sub> ceramic featuring improved toughness and unique friction-reducing coating
- For machining nickel- and cobalt-based super alloys and other difficult-to-machine materials
- Exceptional tool life with metal-removal rates up to ten times greater than carbide  
*U.S. Patent No. 6,447,896 B1*



## New! XSYTIN™-1

- Phase-toughened ceramic
- Capable of extreme feed rates
- Ideal for use in interrupted cuts, scale and milling
- For machining rough forgings and castings of high-strength alloy materials



## GSN100™

- Unique hot-pressed silicon nitride ceramic for machining cast irons
- Superior wear and toughness for turning and milling applications



## GEM -7™

- Al<sub>2</sub>O<sub>3</sub> + TiC composite ceramic for turning
- Roll turning and hard alloy (up to 65 R/c) machining
- Resists notching and has a great degree of tool-wear predictability



## GEM -19™

- Offers high abrasion wear resistance and moderate strength
- For use in areas where interruptions, impact or high hardness are not factors



## Special Inserts

- Custom geometries are available in the grade that best suits your specific needs

# Carbide Inserts

Greenleaf offers a comprehensive line of carbide inserts ranging from sub-micron C-1 through C-8 classifications. Carbide inserts are available in ANSI standard geometries with multi-purpose chipbreakers for heavy roughing through finishing.

## G-915

- PVD-coated carbide for turning and milling high-temp alloys, stainless steels and low-carbon steels
- Allows moderate to high feed rates in turning and milling

## New! G-9120

- PVD-coated carbide for high-performance, high-speed milling and turning of steel castings and steel forgings
- Engineered to maximize your productivity at moderate to heavy feed rates and depths of cut

## New! G-9230

- PVD-coated carbide for cast and forged scale conditions
- High wear resistance and toughness

## G-925

- PVD-coated sub-micron carbide for turning and milling high-temp alloys, titanium and stainless steel
- Resists notching and deformation at moderate to high cutting speeds

## GA5023

- MT-CVD coated carbide for turning and milling cast iron
- Roughing and finishing of gray iron, ductile, nodular and other alloyed irons
- Specifically developed for abrasive wear and shock resistance

## GA5026

- MT-CVD coated sub-micron carbide for high-speed turning nickel- and cobalt-based super alloys and stainless steels
- Exceptional resistance to notching and deformation

## G-935

- PVD-coated carbide for milling and turning a wide range of steel and select stainless steel
- Increases speed capabilities and wear resistance

## GA5035

- MT-CVD coated carbide for turning a broad range of steels and selected stainless steels
- Resists heat deformation, thermal shock and abrasion

## GA5125

- MT-CVD coated carbide for milling alloy steels
- Excellent resistance to abrasion, crater wear, thermal shock, deformation and edge build-up

## GA5036

- MT-CVD coated carbide for high-speed milling of forged and cast steels and selected ductile irons
- The coating's heat resistance makes it suitable for milling at high speeds

## G-5135

- MT-CVD coated carbide for heavy turning of forged steels and ductile and nodular irons
- Extended tool life in heavy depths of cut at medium to high feeds
- Outstanding toughness and exceptional predictability

## GA5040

- MT-CVD coated carbide for milling and turning carbon steel, alloy steel, stainless steel and cast iron
- A general-purpose grade that resists mechanical shock

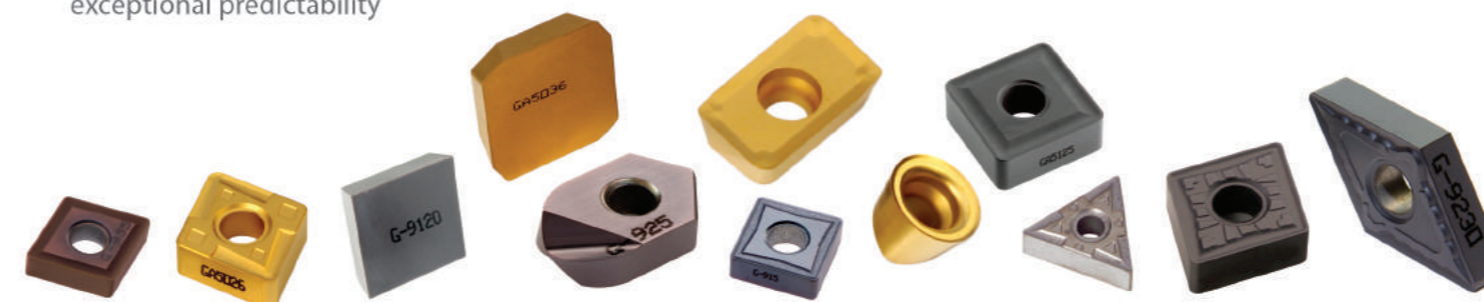

# Special Tooling

Special tooling is a visible strength of the Greenleaf product line. Customers from around the world utilize the Greenleaf engineering service to address their specific and often complex requirements.

- Reduce redundant tooling
- Dramatically increase productivity
- Solve machining problems

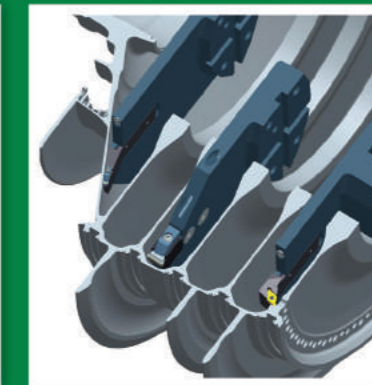
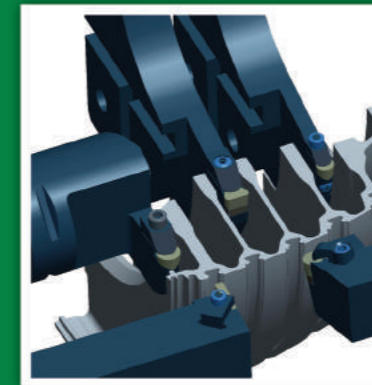
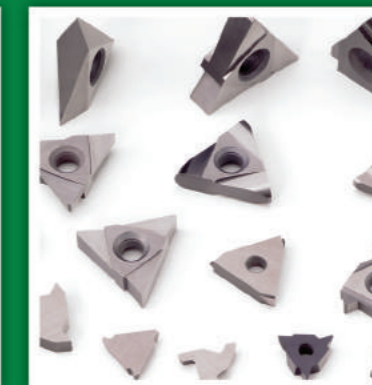

## MILLING CUTTERS

Greenleaf Corporation offers a host of solutions for specialized milling needs. From high speed milling to micro adjustable cutters, Greenleaf has the solution.

## SPECIALTY INSERTS

Greenleaf's vast experience in the tooling industry along with cutting edge design technology allows us to design specialty inserts for maximum productivity in demanding applications.

## TOOLHOLDERS

When standard tooling won't do, let our engineers design tooling for your specific needs.

## COMPLETE SPECIAL TOOLING PACKAGES

With special engineering abilities and experience Greenleaf can offer complete special tooling solutions customized for performance and production efficiency.



# Standard Milling Cutters

High-performance milling cutter systems for virtually any application



## INDEX-O-CUT™

The Index-O-Cut™ is a high-performance milling system for all materials thanks to its high-shear cutting action and the 45° lead angle on the octagon-style insert. These mills are capable of running at higher speeds and feeds than the competition with low horsepower consumption.

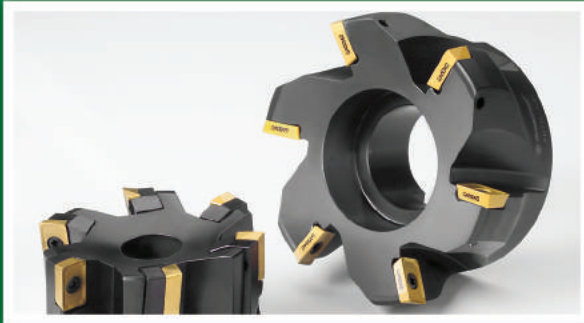

## HUSHCUT®

*Series II Screw-On Insert Cutters*

Quiet and free-cutting mills. The screw-on insert design makes the most of available horsepower and improves tool life. Provides excellent finish and utilizes all four insert corners.



## POWERMILL® CUTTERS

Ideal for heavy-duty cutting in severe interruptions and uneven surfaces. Replaceable components maximize cutter life while providing deep depths of cut. The face mills are available with standard and sinusoidal inserts.



## HIGH SHEAR CUTTERS

Produce excellent surface finish and material removal rates on a variety of materials. End mills offer a protected screw-on insert pocket design.



## SLOTING CUTTERS

Standard screw-on and mechanically held indexable slotting cutters.

- Powerslot® II – adjustable-width slotter
- Narrow-width slotter

# Ring Max™ Ring-Groove Cutter

A complete ring-groove tooling solution

*Greenleaf's new Ring Max™ II is engineered for greater serviceability and now machines a wider range of standard API ring grooves!*

Designed specifically for the oil industry, Greenleaf's Ring Max™ II line of ring groove tooling is engineered to cut machining time of API ring grooves. Combined with our WG-300® whisker-reinforced ceramic inserts, Ring Max™ II tools can reduce cutting time from 30 minutes or more to less than one minute.

- Finishes API ring grooves in Inconel 625 clad overlay in less than one minute
- Creates industry-standard API grooves including BX, R and RX styles
- Replaceable cartridges designed for easy maintenance
- Groove and chamfers are simultaneously machined in one operation
- Also available for grooving in stainless steel and alloy steel
- Available in both pre-clad and finish cutters

*There's a Greenleaf high-performance insert grade for every ring groove need...*

- WG-300® whiskered ceramics for Inconel 625 clad overlay
- Carbide grade G-915 for stainless steel
- Carbide grade GA5036 for alloy steel

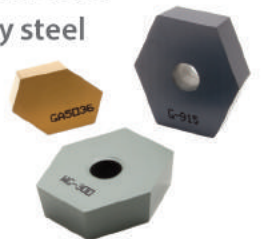

*The Ring Max™ III Modular system for shop versatility*

- High-precision, two-piece modular system
- Offering multiple head and shank configurations
- Shanks also accept Greenleaf face mills
- Ultimate economical and flexible solution
- Repeatable, dependable, secure - every time!



# Aerospace



Greenleaf designs and manufactures tooling solutions for the unique problems common to manufacturing jet engine components. High-nickel alloys, stainless steels and titanium alloys are all part of our daily challenges.

Most of the world's commercial and military jet aircraft soar on turbine engines machined with Greenleaf's advanced cutting tools and toolholding systems.

# Crankshaft Milling

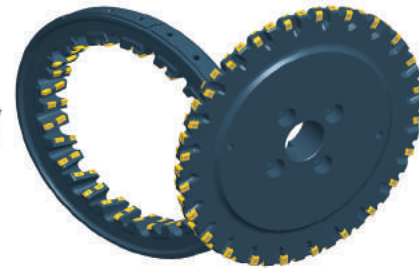

Greenleaf's industry-leading crankshaft milling cutters are manufactured to exacting engineering standards. Greenleaf utilizes a segmented cutter system designed to maintain precision tolerances required on heavy-duty crankshafts and camshafts. Coupled with Greenleaf's rugged, high-performance carbide grades, these cutters are the ultimate solution to machining large crankshafts.

# Rail Milling

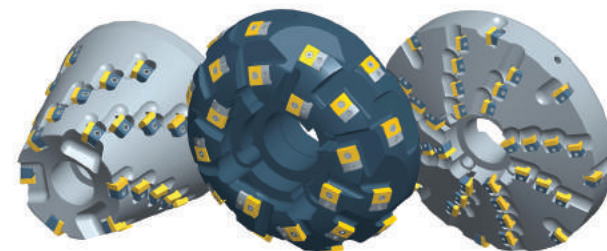

The tough demands of rail, frog and switch milling are met with Greenleaf's heavy-duty rail milling cutters and inserts. Rugged cutters designed for maximum durability and productivity combined with carbide grades optimized for high manganese steel milling will provide the outstanding performance required for rail track machining operations.

# Excelerator® Milling Cutters

Versatile cutters designed to accept carbide or ceramic inserts



## BALL NOSE

SIZE RANGE: 3/8" - 1" (10mm - 25mm)

Our ball nose end mills are the only ball nose cutters designed to use ceramic and carbide inserts in the same qualified cutter bodies. Combined with our WG-600® ceramic and G-925 carbide inserts, *the unique cutter geometry offers better performance, longer tool life and superior cutting action over competitors' mills across a wider spectrum of materials.* U.S. Patent No. 8,177,459 B2



## XF EXTREME FEED

SIZE RANGE: 1" - 12" (25mm - 315mm)

Always on the cutting edge of productivity, Greenleaf engineered the Excelerator® XF milling cutter system. *The Excelerator® XF is designed for high-feed milling on a wide variety of materials including hard steels and high-temp alloys* using Greenleaf's advanced ceramic and carbide inserts.



## FACE MILLS

SIZE RANGE: 2" - 12" (50mm - 315mm)

High-velocity cutters with ceramic inserts for use in a variety of materials at high speeds and accelerated feed rates. *Greenleaf cutters have been engineered to offer outstanding performance with ceramic inserts at elevated spindle speeds on the most demanding materials.* Precision nests provide multiple insert configurations and body protection.



## END MILLS

SIZE RANGE: 3/8" - 2-1/2" (10mm - 63mm)

High-velocity cutters with ceramic inserts for use in a variety of materials at high speeds and accelerated feed rates. *Greenleaf's end mills are designed for high-performance milling in difficult to machine materials.* Utilizes indexable inserts and offers secure insert clamping at high RPMs.



# Tube Scarfing

Longer tool life, fast changing of tooling, indexable inserts.



## GA5023

- MT-CVD ceramic-coated grade
- Developed for abrasive wear & shock resistance

## GA5025

- MT-CVD ceramic-coated grade
- Superior heat resistance and long tool life

## GEM-19™

- Al<sub>2</sub>O<sub>3</sub> ceramic grade
- For high-speed operations
- For demanding finish requirements

Tube scarfing systems from Greenleaf using our indexable inserts offer decreased downtime, longer tool life, faster tool change time, decreased tool costs and elimination of regrinding problems. Superior seams can be achieved since an accurate radius form is always available on each side of the insert.

# Bar Peeling

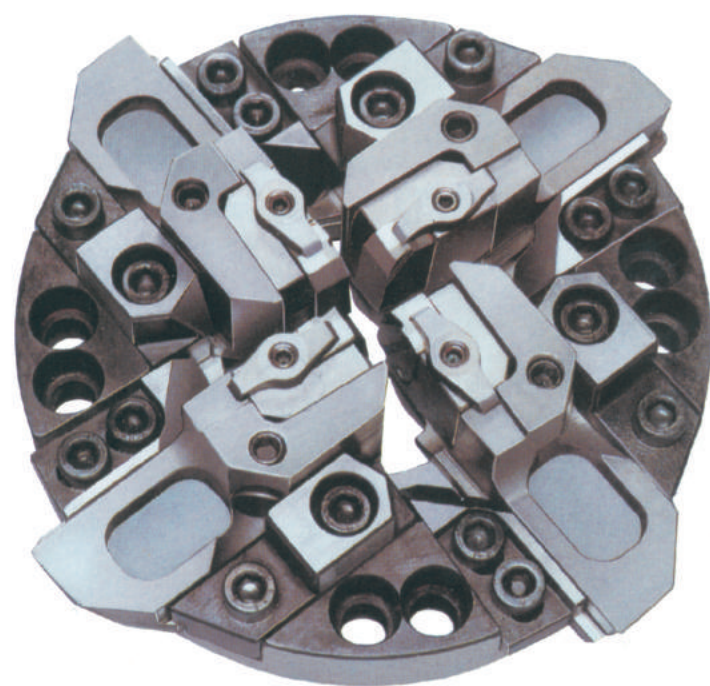

Utilizing advanced 3-D modeling and CNC manufacturing equipment, Greenleaf can provide a bar peeling solution from the machine spindle through the cutting tool insert. A complete tooling system engineered to meet your requirements.

- Daisho
- Kieserling
- Medart/Blaw Knox
- Hetran

# Turning & Boring

Industry-standard turning and boring tools engineered for maximum productivity and tool life

- For heavy roughing to finishing operations
- ANSI/ISO qualified
- Available in a selection specially designed to optimize the use of ceramic inserts
- Available in a wide variety of styles for all common insert geometries



## TOOLHOLDERS

Greenleaf manufactures a complete line of industry standard toolholders in conformance with ANSI specifications for carbide inserts.

Greenleaf's toolholder systems for use with ceramic inserts are based upon industry standard hardware. However, geometry and pocket depth are designed to maximize ceramic performance.

## BORING BARS

Greenleaf's boring bar systems and cartridges are designed around industry standard hardware. **This gives complete interchangeability with other tooling components and minimizes spare parts.** Greenleaf can supply heavy metal or "No Chat" high-density tungsten alloy bars that can reduce and sometimes eliminate chatter for those applications that require a longer reach.

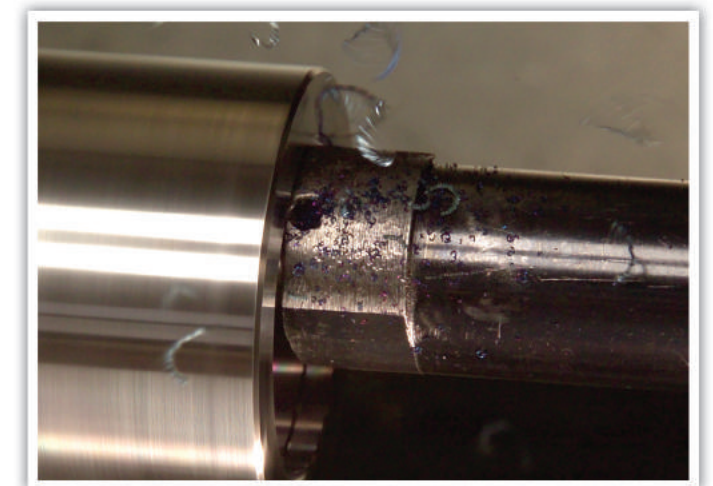

## ROUGH STUFF®

Greenleaf's Rough Stuff® surface treatment greatly improves insert-gripping power for greater accuracy, speed and pocket retention. **Available on WG-300®, WG-600®, WG-700™ and GSN100™ ceramics.** U.S. Patent No. 6,712,564 B1



# Heavy Turning



Greenleaf has extensive experience in the design and manufacture of heavy-turning tooling systems. These systems are extremely productive in heavy-turning applications with both carbide and ceramic inserts.

- Farrel quick change tooling
- 1.5" (38 mm) shank standard tools and components for heavy duty lathes
- High-performance carbide and ceramic inserts
- Nearly 70 years of heavy turning experience



# Indexable Drilling



## HOLEMILL™ SYSTEM

An indexable drill utilizing Greenleaf's advanced coated-carbide grades for higher speeds, quieter cutting, longer tool life and reduced horsepower consumption. Available in .937"-3" (24mm - 40mm) diameters.

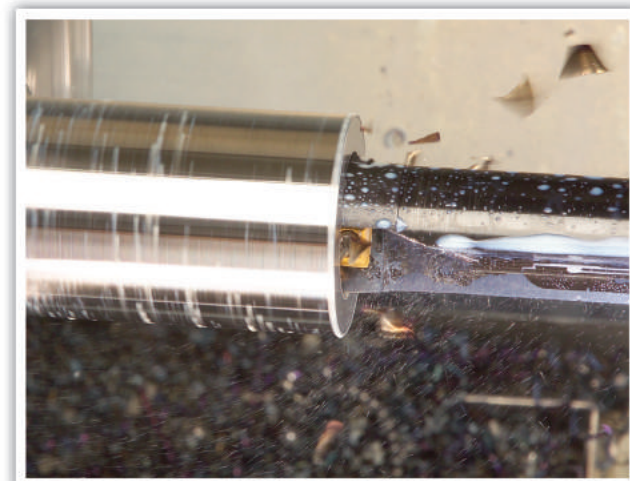

# Grooving, Profiling & Cut-Off

Offering up to 248 available support blade and shank combinations

## GTS

### Groove Turn System

GTS inserts offer high-speed performance in a chip form geometry specifically designed to allow the Greenleaf carbide grooving insert to double as a turning tool when the application dictates. **GTS carbide inserts are qualified to fit into the same pocket as its standard ceramic groover counterpart.**



## COS

### Cut-Off System

Greenleaf's advanced cut-off system features inserts that are qualified to fit into standard Greenleaf grooving tools while maintaining superior performance.

## COMPLETE SYSTEM

Greenleaf's toolholder system for grooving, profiling and cut-off applications is designed to accept carbide or ceramic inserts. **The system features a "V"-bottom pocket design for superior insert stability and precision cutting.** An interchangeable support-blade system includes stocked Capto and KM quick-change shanks.

