

CATALOGO DC SWISS SA

CATALOGUE DC SWISS SA



Catalogue Catalogo

FR-IT-ID TC.1



FR-IT-ID TC.1





TAP



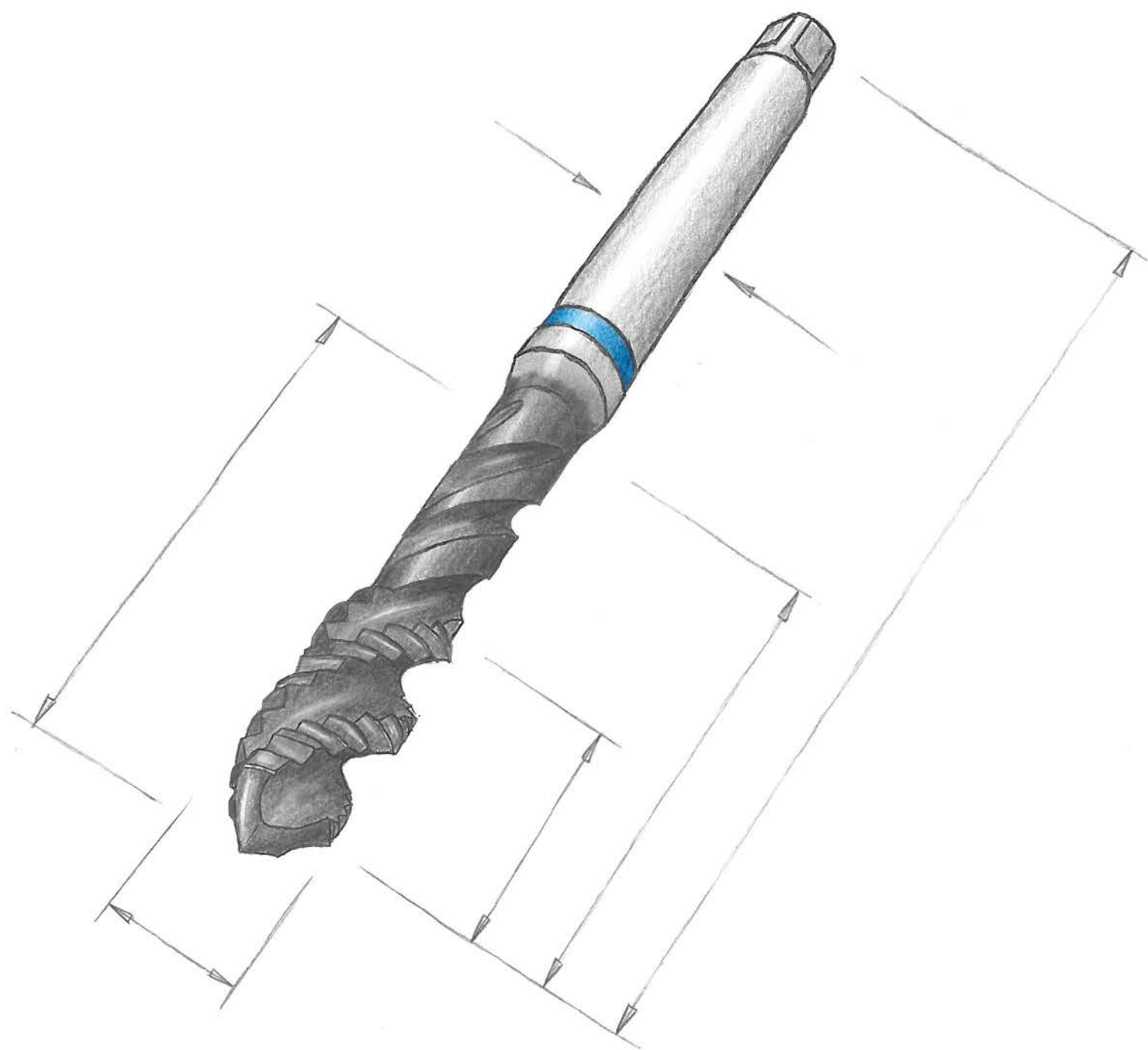



DISPONIBILITÉ DES ARTICLES

- ID Article en stock
- ID Disponible à court terme
- * ID Disponible jusqu'à épuisement du stock

DISPONIBILITÀ DEGLI ARTICOLI

- ID Articoli in stock
- ID Disponibile a breve
- * ID Articoli disponibili sino ad esaurimento



Notre entreprise située dans le Jura bernois en Suisse est nichée entre les collines et les rives de la Birse depuis 1940. C'est dans ce cadre idyllique que sont développés et produits les outils de filetage haut de gamme de notre marque DC et c'est d'ici, également, qu'ils sont livrés dans le monde entier.

Depuis la fondation de la société, nous nous sommes focalisés sur l'élargissement de notre gamme de tarauds HSSE / HSSE-PM afin de répondre de la meilleure façon aux besoins de notre clientèle et sur le développement de nouveaux types d'outils pour les technologies et les matériaux les plus récents.

Afin de favoriser les développements et la production des outils de filetage en carbure monobloc, tels que les fraises à fileter et les tourbillonneurs, nous avons créé le département « ONE STEP » durant l'année 2000, un nouveau secteur de production équipé des dernières technologies de production permettant de garantir la fiabilité et la performance de nos outils de filetage en carbure.

Depuis 2010, notre programme de tarauds coupants, refouleurs, tourbillonneurs et jauges de filetage s'est considérablement développé. Un accent tout particulier a notamment été mis sur le développement de nos micro-outils, représentés par notre programme NANO proposant un large choix d'outils d'un diamètre de 0.3 mm à 2.75 mm, qui comprend des tarauds, refouleurs, tourbillonneurs, jauges de contrôle et rapporteurs. En tant que société accréditée ISO 17025:2017, DC Nano Tools SA est votre spécialiste dans ce domaine.

Aujourd'hui, nos outils de filetage de haute performance sont utilisés dans le monde entier et dans tous les secteurs d'activité où **qualité, performance** et **fiabilité** sont des éléments primordiaux et essentiels dans le processus de fabrication de nos clients.

Et si vous ne trouvez pas l'outil que vous cherchez dans notre vaste gamme de programmes standards, nous modifierons nos outils pour répondre à vos besoins ou créerons des outils sur mesure à partir de vos spécifications.

Finalement, pour les questions auxquelles vous ne trouvez pas de réponse dans notre catalogue, nos équipes sont bien entendu à votre disposition pour répondre à chacune de vos demandes.



*"Au début, je cherchais les meilleurs outils,
puis j'ai décidé de les fabriquer moi-même"*

Daniel Charpilloz – 1940



La nostra innovativa PMI è di casa nel Giura bernese in Svizzera, idillicamente incastonata tra le colline e sulle rive dell'ancora giovane fiume Birs. È qui che dal 1940 gli utensili per filettare ad alte prestazioni del nostro marchio DC vengono sviluppati, prodotti e forniti in tutto il mondo.

Fin dalla fondazione della nostra azienda, ci siamo concentrati sull'ampliamento della nostra gamma di maschi in HSSE / HSSE-PM per soddisfare in modo ottimale le esigenze dei nostri clienti e sullo sviluppo costante di nuovi tipi di utensili per le più recenti tecnologie e materiali.

Nel 2000 abbiamo creato la nuova divisione di produzione "ONE STEP", dotata delle più moderne tecnologie di produzione, per lo sviluppo e la produzione di frese per filettatura e frese a filettare vorticoso in metallo duro integrale affidabili e performanti. Nel frattempo, il nostro programma in metallo duro integrale è stato notevolmente sviluppato e ampliato, con particolare attenzione alle frese per filettatura.

Dal 2010, una particolare attenzione è stata dedicata allo sviluppo dei nostri micro utensili. Il risultato è il nostro programma "NANO", molto ampio e completo, che comprende maschi di taglio e a rullare, frese a filettare vorticoso, calibri filettati, e calibri di controllo a spina, nel range di diametro da 0.3 a 2.75 mm. In qualità di azienda accreditata ISO 17025:2017, DC Nano Tools SA è il vostro specialista e riferimento in questo campo.

Oggi, i nostri utensili di filettatura ad alte prestazioni vengono utilizzati in tutto il mondo e in tutti i settori in cui la **qualità**, le **prestazioni** e l'**affidabilità** dei prodotti sono di primaria importanza.

Se non trovate ciò di cui avete bisogno nella nostra vasta gamma di prodotti standard, possiamo modificare gli utensili in base alle vostre esigenze o produrre articoli speciali specifici, in base alle vostre specificazioni e ai vostri disegni.

Per domande, alle quali non trovate risposta nel nostro catalogo, siamo naturalmente a vostra completa disposizione.



*"All'inizio cercavo gli utensili migliori,
poi ho deciso di produrli io stesso"*

Daniel Charpilloz – 1940

TOUJOURS PRÈS DE VOUS

DC SWISS DANS LE MONDE ENTIER



PROXIMITÉ AVEC LES CLIENTS

Vous trouverez toujours un interlocuteur compétent, que ce soit à l'usine mère en Suisse, dans l'une de nos filiales en Allemagne, en Italie et en Angleterre, ou encore chez l'un de nos nombreux distributeurs ou l'un de nos représentants dans le monde.

SUPPORTO ALLA CLIENTELA

Troverete sempre una persona di riferimento competente, sia presso la nostra sede principale in Svizzera, sia presso una delle nostre filiali in Germania, Italia e Inghilterra, sia presso uno dei nostri numerosi rappresentanti o rivenditori in tutto il mondo.

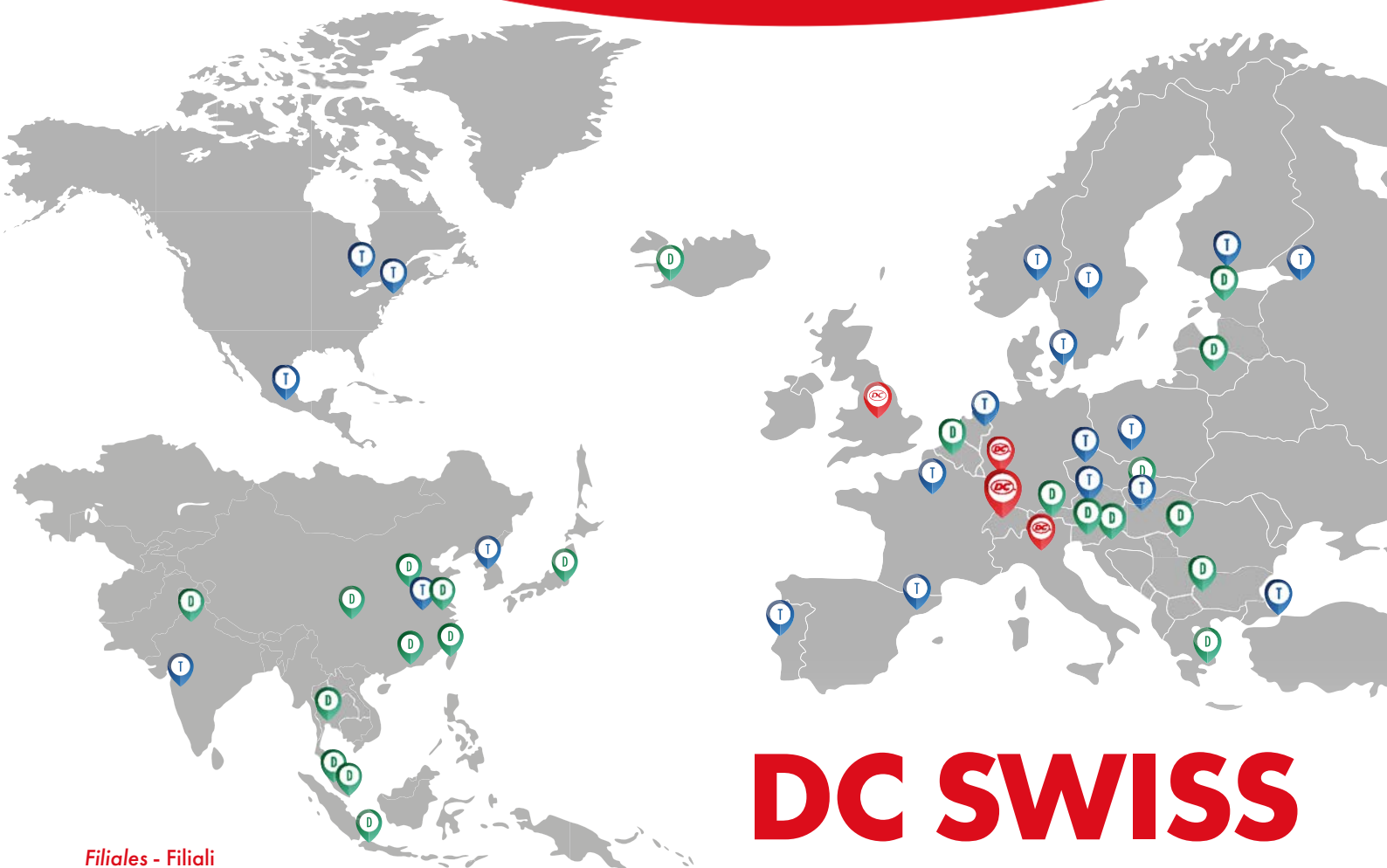

Filiales - Filiali

Partenaires technologiques - Partner tecnologici

Distributeurs - Distributori

Per altri paesi : <http://dcswiss.com/réseau-de-vente>
Per altri paesi: <http://dcswiss.com/it/rete-di-vendita>

DC SWISS NEL MONDO

E SEMPRE VICINO A VOI

SWISS QUALITY

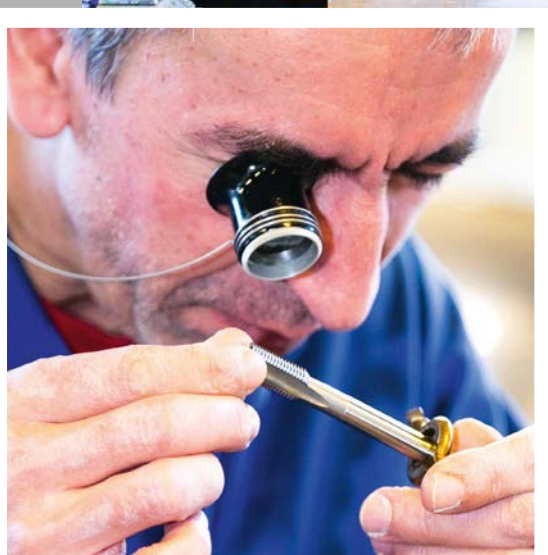

100 % made by DC SWISS - garanti depuis le développement de l'outil jusqu'à sa fabrication et son contrôle final, grâce à notre savoir-faire et à notre compétence dans tous les domaines de la fabrication d'outils de filetage.

100 % made by DC SWISS - garantito dallo sviluppo dell'utensile alla sua produzione e fino al controllo finale, grazie al nostro know-how e alle nostre competenze in tutto il settore della produzione di utensili per filettatura.

NOS VALEURS

PERFORMANCE

La performance est au centre de nos réflexions pour le développement de nouvelles solutions et l'amélioration de nos produits "catalogue" aux besoins de nos clients. Nous attachons une grande importance à un rapport prix/performance constant comme base d'une relation de confiance avec nos clients.

I NOSTRI VALORI

PRESTAZIONI

Facciamo ogni sforzo per sviluppare soluzioni personalizzate e per adattare le prestazioni dei nostri utensili standard alle attuali esigenze dei nostri clienti. Attribuiamo grande importanza a un rapporto prezzo/prestazioni costante come base per un rapporto di fiducia con i nostri clienti.



AUTOMOBILE
SETTORE AUTOMOBILISTICO

INDUSTRIE HORLOGÈRE
INDUSTRIA DELL'OROLOGERIA

AÉROSPATIALE
SETTORE AEROSPAZIALE

TECNOLOGIE MÉDICALE
SETTORE MEDICALE

SOLUTIONS SUR-MESURE
SOLUZIONI PERSONALIZZATE



SAVOIR-FAIRE

La valeur de notre savoir-faire se traduit par une manière unique de résoudre les problèmes et d'associer l'ensemble des connaissances, des expériences et des compétences accumulées depuis 1940.

KNOW-HOW

Il valore del nostro know-how rappresenta in modo unico la soluzione dei problemi e articola, implementa e associa l'insieme delle conoscenze, delle esperienze e delle competenze accumulate dal 1940.

FIABILITÉ

Nous savons que les relations durables se construisent uniquement sur la base de la confiance, de la transparence et de l'engagement quotidien de chacun de nos collaborateurs à fournir à notre clientèle des outils et services d'une excellente qualité.

AFFIDABILITÀ

Sappiamo che relazioni durature possono essere costruite solo sulla base della fiducia, della trasparenza e degli sforzi quotidiani di ciascuno dei nostri dipendenti per fornire ai nostri clienti strumenti e servizi di qualità eccellente.



PROFIL DE L'ENTREPRISE

ENTREPRISE FORMATRICE

DC SWISS SA s'engage activement dans la formation des jeunes et la formation continue des spécialistes déjà expérimentés. En tant que détenteur du label "**Entreprise formatrice**", c'est un honneur pour nous de former de nouveaux apprentis chaque année.

Il nous tient à cœur d'assurer la relève professionnelle et d'offrir des perspectives d'évolution et de perfectionnement, dans un domaine à fort potentiel.



PROFILO DELL'AZIENDA

AZIENDA DI FORMAZIONE

DC SWISS SA partecipa attivamente alla formazione dei giovani e al perfezionamento di specialisti già esperti. In qualità di titolari del marchio "**azienda di formazione**", è una questione d'onore per noi formare ogni anno nuovi apprendisti.

Per noi è importante assicurare la prossima generazione di professionisti e offrire loro le opportunità di sviluppo e di ulteriore formazione in un settore ad alto potenziale.



Filière
de formation
POLYMÉCANICIEN

Nous sommes également membre du programme d'apprentissage polymécanique; un réseau de 6 entreprises dont le but est de former des apprentis polymécaniciens.

Siamo anche membri del programma di apprendistato di polimeccanico; una rete di 6 aziende il cui obiettivo è quello di formare apprendisti polimeccanici.



Polymécanicien(ne) CFC - Polimeccanico(a) AFC

Mécanicien(ne) de production CFC - Meccanico(a) di produzione AFC

Logisticien(ne) CFC - Logista AFC

Employé(e) de commerce CFC - Impiegato(a) commerciale AFC

CFC = Certificat fédéral de capacité

AFC = Attestato federale di capacità



Réduire nos émissions de CO2
et améliorer notre efficacité énergétique
Ridurre le nostre emissioni di CO2
e migliorare la nostra efficienza energetica



Privilégier l'utilisation de **matériaux recyclés ou recyclables**
Favorire l'uso di **materiali riciclati o riciclabili**



Trier nos déchets
La selezione dei nostri rifiuti



PROTECTION DE L'ENVIRONNEMENT

Nous nous engageons activement à protéger l'environnement et le climat, à réduire notre consommation d'eau et d'électricité ainsi qu'à limiter les déplacements professionnels de nos collaborateurs au strict nécessaire. Nous gérons ainsi les ressources de manière hautement responsable.

PROTEZIONE DELL'AMBIENTE

Siamo attivamente impegnati a proteggere l'ambiente e il clima, a ridurre i nostri consumi di acqua ed elettricità e a limitare i viaggi di lavoro dei nostri dipendenti all'essenziale. Nel fare ciò, utilizziamo le risorse in modo altamente responsabile.

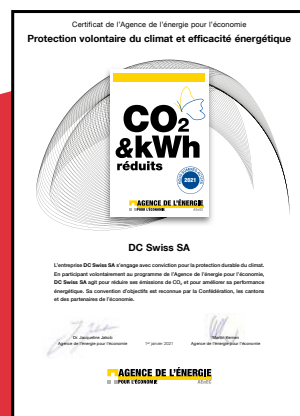

Saviez-vous que DC Swiss SA a conclu un accord avec l'Agence de l'énergie pour l'économie et la Confédération suisse ?

Lo sapevi che DC Swiss SA ha concluso un accordo con l'Agenzia dell'energia per l'industria e la Confederazione Svizzera?



**TARAUDE CLASSIQUE
MASCHIATURA CLASSICA**



**TARAUDE PAR DÉFORMATION
MASCHIATURA PER DEFORMAZIONE**



**AÉROSPATIALE
SETTORE AEROSPAZIALE**



**FRAISAGE DE FILETS
FRESATURA DI FILETTI**



**AUTOMOBILE
SETTORE AUTOMOBILISTICO**



**TECHNOLOGIE MÉDICALE
SETTORE MEDICALE**



**SOLUTIONS SUR-MESURE
SOLUZIONI PERSONALIZZATE**

PRODUCTION D'ÉNERGIE
PRODUZIONE DI ENERGIA



INDUSTRIE HORLOGÈRE
INDUSTRIA DELL'OROLOGERIA



MÉCANIQUE GÉNÉRALE
MECCANICA GENERALE



TOURBILLONNAGE
FILETATURA VORTICOSO



JAUGES DE FILETAGE
CALIBRI FILETTATI



MANDRINS DE TARAUDAGE
MASCHIATORE



FILIÈRES
FILIERE



NOS COMPÉTENCES

SERVICE D'ÉTALONNAGE ET DE MÉTROLOGIE

DC SWISS possède une entité métrologique accréditée par le Service d'accréditation suisse en tant que Laboratoire d'étalonnage pour les longueurs.

DC SWISS est en mesure d'offrir un service d'étalonnage et de métrologie dans les domaines des liaisons vissées.

Un certificat est une confirmation écrite attestant de la qualité de l'équipement métrologique de l'entreprise. DC NANO TOOLS SA (Accréditation SCS 0143), membre du Groupe DC SWISS, vous propose le contrôle et l'étalonnage des jauges tampons filetées ainsi que des jauges bagues filetées selon la norme internationale standardisée ISO 17025.

Nos outils sont le fruit de nombreuses études. Nous les élaborons avec la somme des connaissances acquises au fil de nombreuses années et toujours en les essayant jusque dans leurs plus ultimes limites. Tout ce savoir-faire, nous le partageons avec vous sous la forme de services. Notre objectif est de fournir la solution la plus appropriée à chaque cas, depuis l'étude jusqu'à la fabrication en volume.

Nous maîtrisons tous les aspects du processus de filetage et nous sommes à même de vous proposer notre expertise dans l'assemblage dès la conception, puis l'usinage et le contrôle métrologique aux différents stades de la création des liaisons vissées.

Expertise conception

Chaque conception est unique, mais les solutions sont souvent multiples. Nous vous conseillons dans le choix du type de liaison vissée, comme les vis réglables, autobloquantes et de haute qualité. Nous intervenons avec vos concepteurs lors de la phase de création afin de trouver et dimensionner la liaison vissée la plus performante en termes de dimension, faisabilité, coût de production et d'assemblage.

Expertise usinage

Chaque outil demande une programmation particulière en fonction de nombreux paramètres. Nous vous aidons à tirer le meilleur de vos machines et vos outils afin d'atteindre la performance maximale par une programmation personnalisée. Nous vous fournissons le soutien dans la phase de contrôle et de mesure afin que vous soyez certains d'avoir produit le filetage que vous attendiez. Et si l'outil doit être adapté, nous le réalisons afin qu'il satisfasse à la perfection vos exigences. Souvent un posage particulier permet de résoudre la difficulté d'une géométrie complexe ou une position atypique.

Expertise métrologique

Nous fournissons un grand nombre de jauges de mesure et également la manière de les utiliser et surtout de les contrôler afin d'assurer la qualité désirée avec constance. D'autres mesures plus spécifiques sont accessibles, comme la concentricité ainsi que toutes les mesures de certification. Nous vous soutenons dans l'établissement des procédures de contrôle. Ce service est offert dans les dimensions allant du diamètre 0.1 à 3.0 mm pour la mesure du diamètre sur flanc et de 0.1 à 3.5 mm pour le diamètre extérieur. Ne prenez pas de risques et profitez des compétences de DC NANO TOOLS SA pour l'étalonnage de vos outils de mesure.

Formation

Dans notre centre d'applications et notre laboratoire, nous dispensons à tous nos clients toute l'information et les meilleures pratiques qui concernent la conception, la fabrication et l'usage des liaisons vissées. Sur demande, nous approfondissons la formation sur des sujets précis ou spécifiques comme les liaisons sécurisées par exemple.

LA NOSTRA ESPERIENZA

SERVIZIO DI TARATURA E METROLOGIA

DC SWISS dispone di un laboratorio di metrologia accreditato dal Servizio di accreditamento svizzero come laboratorio per la taratura delle lunghezze.

DC SWISS è in grado di offrire un servizio di taratura e metrologia per una ottimale filettatura.

Viene rilasciato un certificato che è la conferma scritta della qualità delle apparecchiature metrologiche di un'azienda come DC NANO TOOLS SA (accreditamento SCS 0143), membro del gruppo DC SWISS, che è in grado di ispezionare e calibrare i tamponi a vite e gli anelli di misura per filettatura secondo la norma internazionale ISO 17025.

I nostri utensili sono il risultato di numerosi studi. Li progettiamo utilizzando tutte le conoscenze che abbiamo acquisito nel corso di molti anni, testandoli sempre con la massima cura. Condividiamo con voi tutte queste conoscenze sotto forma di servizi. Il nostro obiettivo è quello di fornire la soluzione più appropriata in ogni caso, dallo studio di fattibilità fino alla produzione in serie.

Siamo esperti in tutti gli aspetti del processo di filettatura delle viti e siamo in grado di offrirvi la nostra esperienza di montaggio, dalla progettazione, alla lavorazione e al controllo metrologico, passando per le varie fasi di creazione filettate.

Competenza di progettazione

Ogni progetto è unico, ma ci sono spesso più soluzioni. Possiamo consigliarvi su quale tipo di fissaggio a vite scegliere, ad esempio viti regolabili, autobloccanti e viti di alta qualità. Durante la fase di progettazione, possiamo aiutare i vostri progettisti a individuare e decidere il fissaggio a vite più performante in termini di dimensioni, fattibilità, costi di produzione e montaggio.

Competenza di lavorazione

Ogni utensile richiede una programmazione speciale che coinvolge numerosi parametri. Possiamo aiutarvi ad ottenere il meglio dalle vostre macchine e dai vostri utensili per ottenere il massimo delle prestazioni attraverso una programmazione personalizzata. Possiamo fornirvi supporto nella fase di ispezione e misurazione, in modo che possiate essere sicuri di aver prodotto la filettatura della vite che vi aspettavate. E se un utensile deve essere personalizzato, possiamo farlo in modo che soddisfi tutte le vostre esigenze. Spesso, un particolare approccio al montaggio permette di risolvere un problema causato da una geometria complessa o da un posizionamento non ottimale.

Competenza metrologica

Forniamo un gran numero di misuratori e anche consigli su come utilizzarli e controllarli per garantire la qualità richiesta. Sono disponibili altre misure più specifiche, come la concentricità e le misure di certificazione. Possiamo assistervi nell'impostazione delle procedure di controllo. Questo servizio è disponibile per diametri sul fianco da 0.1 a 3.0 mm e per diametri esterni da 0.1 a 3.5 mm. Non correte il rischio - approfittate dell'esperienza di DC NANO TOOLS SA per calibrare i vostri strumenti di misura.

Formazione

Nel nostro centro di applicazione e nel nostro laboratorio, distribuiamo a tutti i nostri clienti informazioni complete e consigli sulle migliori pratiche nella progettazione, produzione e utilizzo dei fissaggi a vite. Siamo in grado di fornire una formazione su richiesta su argomenti specifici come i fissaggi sicuri.



PROFIL DE L'ENTREPRISE

CERTIFICATION ISO 9001

Tous les domaines de l'entreprise sont certifiés ISO 9001 depuis 2006.

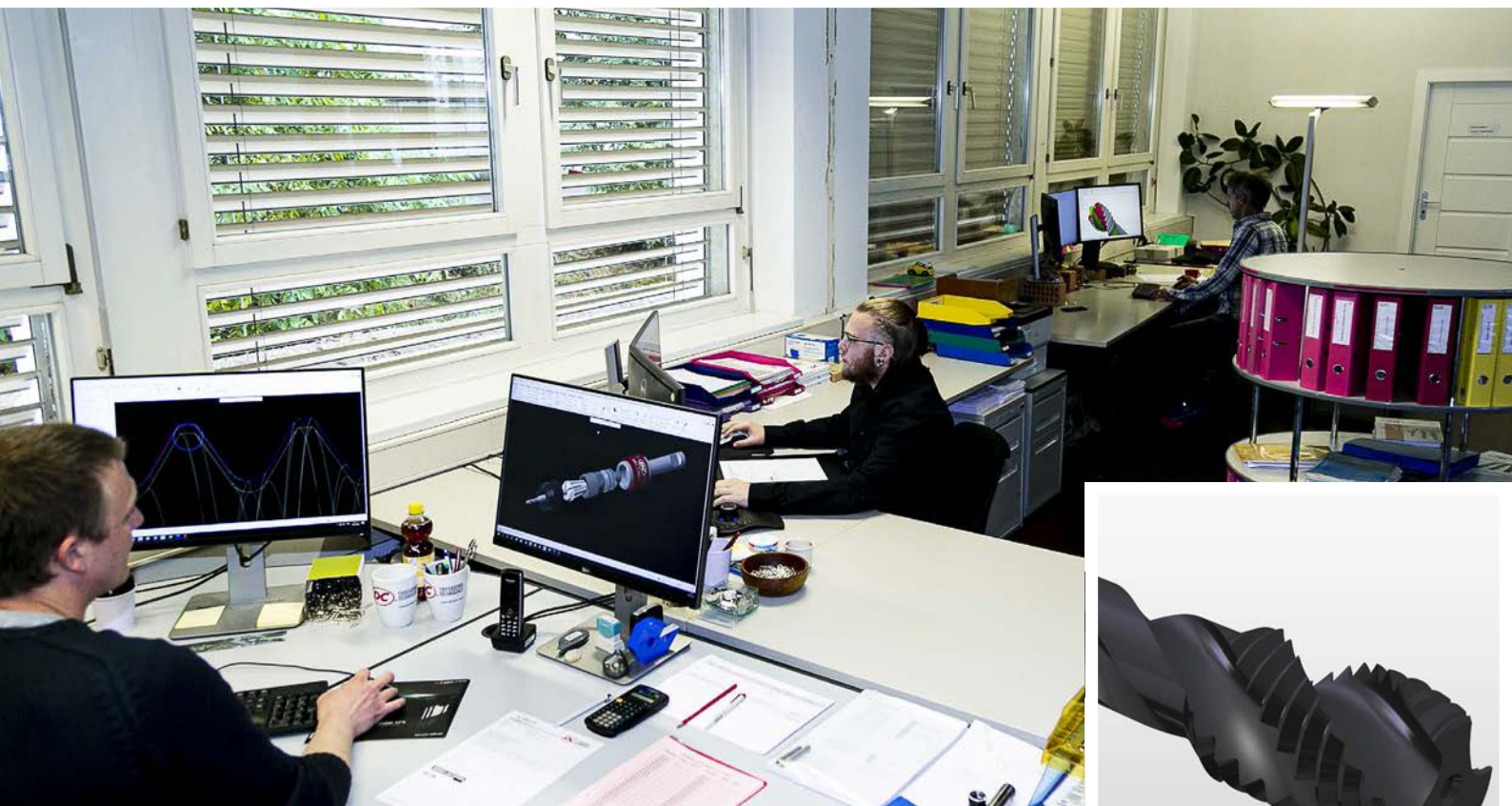

PROFILO DELL'AZIENDA

CERTIFICAZIONE ISO 9001

Tutti i settori dell'azienda sono certificati ISO 9001 dal 2006.

- ✓ *Recherche permanente d'amélioration de la satisfaction et de la fidélisation de nos clients.*
Miglioramento continuo della soddisfazione e della fedeltà dei clienti.
- ✓ *Respect des normes en matière de produits dans nos processus et procédés et optimisation de ces derniers.*
Soddisfare gli standard di prodotto nei nostri processi e procedure e ottimizzarli.
- ✓ *Diminution des coûts liés à la qualité (rebuts, retouches, ...).*
Riduzione dei costi legati alla qualità (scarti, ritocchi, ...).
- ✓ *Amélioration de l'efficacité organisationnelle et structurelle.*
Miglioramento dell'efficienza organizzativa e strutturale.
- ✓ *Augmentation de la capacité d'adaptation à l'évolution.*
Maggiore capacità di adattamento al cambiamento.
- ✓ *Implication du personnel dans le processus d'amélioration permanente.*
Coinvolgere il personale nel processo di miglioramento continuo.

The management system of

DC Swiss SA

CP 363,
Grand rue 19
CH - 2735 Malleray



has been assessed and certified as meeting the requirements of

ISO 9001:2015

For the following activities

**Design, development, manufacturing, marketing, sales and distribution
of cutting tools. Expertise in threading technology.**

This certificate is valid from 19 June 2018 until 18 June 2021
and remains valid subject to satisfactory surveillance audits
Recertification audit due before 7 June 2021
Issue 6. Certified since September 2007

Authorised by



SGS Société Générale de Surveillance SA
Technoparkstrasse 1 8005 Zurich Switzerland
t +41 (0)44 445-16-80 f +41 (0)44 445-16-88 www.sgs.com

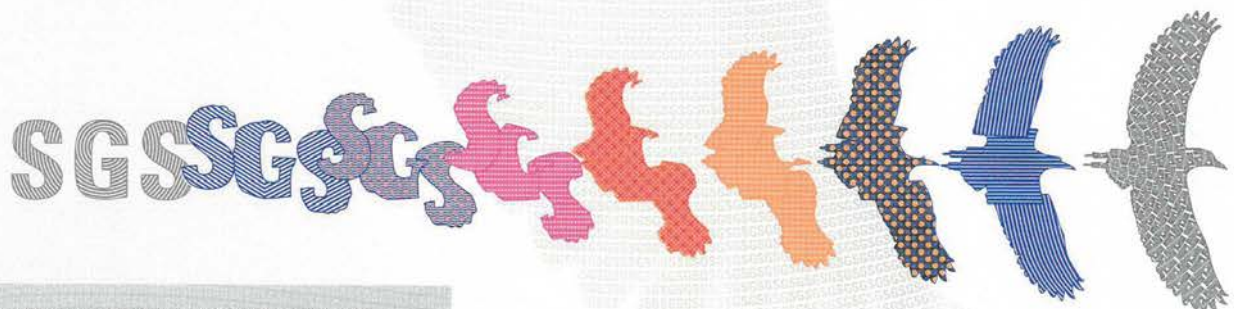

DIMENSIONS GÉNÉRALES SELON ISO / DIN

DIMENSIONI GENERALI SECONDO ISO / DIN



N1120-4 ISO 529

Queue ISO courte renforcée — Gambo ISO corto rinforzato



N1220-4 ISO 529

Queue ISO courte passante — Gambo ISO corto passante



N320-4 DIN 371

Queue DIN renforcée — Gambo DIN rinforzato



N420-4 DIN 376 / DIN 374

Queue DIN passante — Gambo DIN passante



N520-4 NORM DC

Taraud à machine extra-long avec queue DIN renforcée; longueur totale selon norme d'usine DC

— Maschio a macchina extra-lungo con gambo DIN rinforzato; lunghezza totale secondo lo standard di fabbrica DC



Taraud à machine extra-long avec queue DIN passante; longueur totale selon norme d'usine DC

— Maschio a macchina extra-lungo con gambo DIN passante; lunghezza totale secondo lo standard di fabbrica DC

DIMENSIONS DU TARAUD — DIMENSIONI DEL MASCHIO

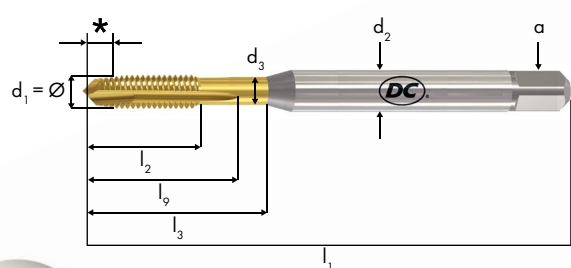

*	<i>Longueur d'entrée</i>	Lunghezza dell'imbocco
d₁	<i>Diamètre nominal du filetage</i>	Diametro nominale del filetto
d₂	<i>Diamètre de la queue</i>	Diametro del gambo
d₃	<i>Diamètre du cou</i>	Diametro del collarino
l₁	<i>Longueur totale</i>	Lunghezza totale
l₂	<i>Longueur filetée</i>	Lunghezza del filetto
l₃	<i>Longueur utile</i>	Lunghezza utile
l_g	<i>Longueur des goujures</i>	Lunghezza delle scanalature
a	<i>Carré</i>	Quadro
z	<i>Nombre de goujures</i>	Numero delle scanalature



Lèvre
Spoglia

Goujure
Scanalatura

POINTES DE CENTRAGE — CENTRI MASCHIO







	Filetage	Filetto
	<i>Pointe de centrage pleine</i>	Centrino
	<i>Pointe de centrage épaulée</i>	Centrino ridotto
	<i>Trou de centrage</i>	Foro di centraggio
	Queue	Gambo
	<i>Pointe pleine</i>	Centrino
	<i>Chanfrein de centrage</i>	Centrino a smusso
	<i>Trou de centrage</i>	Foro di centraggio

La forme de la pointe dépend du diamètre du filetage, du type d'outil et de la machine sur laquelle les outils sont fabriqués.

La forma della punta dipende dal diametro del filetto, dal tipo di utensile e dalla macchina su cui vengono fabbricati gli utensili.

FORMES DES GOUJURES POUR TARAUDS DC

FORME DELLE SCANALATURE PER MASCHI DC

	<i>Exemples pour filetages à droites</i>	<i>Esempi per filettatura a destra</i>
	.10 Goujures droites pour trous débouchants et trous borgnes dans matières à copeaux courts	Scanalature diritte per fori passanti e fori ciechi su materiali a trucioli corti
	.20 Goujures droites avec entrée à hélice pour trous débouchants dans matières à copeaux longs	Scanalature diritte con imbocco corretto per fori passanti su materiali a trucioli lunghi
	.30 Entrée à hélice uniquement pour trous traversants dans matières à copeaux longs, pour profondeurs de filetage $\leq 1.5 \times D$; travail de la tôle	Solo imbocco corretto per fori passanti su materiali a trucioli lunghi, per profondità di filettatura $\leq 1.5 \times D$; lavorazione della lamiera
	.40 Goujures faiblement hélicoïdales à gauche pour trous traversants	Scanalature debolmente elicoidali a sinistra per fori passanti
	.50 Goujures faiblement hélicoïdales à droite $\leq 27^\circ$ pour trous débouchants et borgnes dans matières à copeaux courts $\leq 2.5 \times D$ et trous borgnes dans matières à copeaux demi-longs et longs $\leq 1.5 \times D$	Scanalature debolmente elicoidali $\leq 27^\circ$ a destra per fori passanti e fori ciechi su materiali a trucioli corti $\leq 2.5 \times D$ e fori ciechi su materiali a trucioli medio-lunghi e lunghi $\leq 1.5 \times D$
	.60 Goujures fortement hélicoïdales à droite de $> 27^\circ - \leq 40^\circ$ pour trous borgnes dans matières à copeaux longs $\leq 2.5 \times D$	Scanalature fortement elicoidali $> 27^\circ - \leq 40^\circ$ a destra per fori ciechi su materiali a trucioli lunghi $\leq 2.5 \times D$
	.70 Goujures très fortement hélicoïdales à droite de $> 40^\circ$ (R45) pour trous borgnes jusqu'à $3 \times D$ dans des matières tenaces	Scanalature fortement elicoidali $> 40^\circ$ a destra (R45) per fori ciechi fino a $3 \times D$ su materiali tenaci

FORMES DES RAINURES DE LUBRIFICATION POUR TARAUDS À REFOULER DC FORME DELLE SCANALATURE DI LUBRIFICAZIONE PER MASCHI A RULLARE DC



.80

Sans rainures de lubrification

Senza scanalature di lubrificazione



.81

Avec rainures de lubrification

Con scanalature di lubrificazione



.84

Avec rainures de lubrification et canal de lubrification intérieure avec sorties radiales à 45°
(conversion à cette nouvelle version en cours)

Con scanalature di lubrificazione e canale di lubrificazione interna con uscite radiali 45°
(conversione a questa nuova versione in corso)

FORMES D'ENTRÉES POUR TARAUDS ET REFOULEURS DC

FORMA D'IMBOCCO PER MASCHI E MASCHI A RULLARE DC

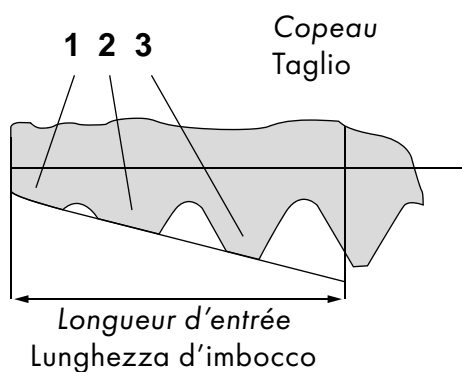

Formation des copeaux à l'entrée
Formazione dei trucioli all'imbocco

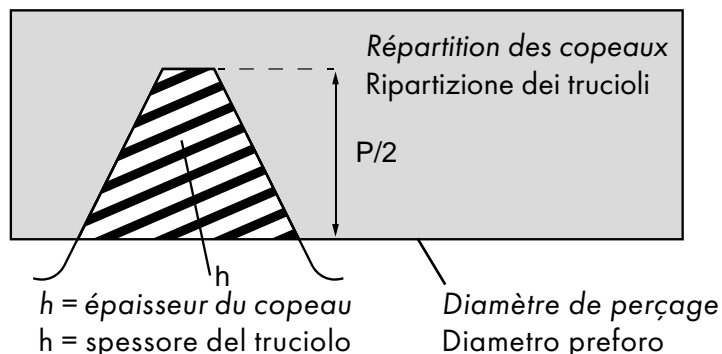

Formes d'entrées et longueurs d'entrées pour tarauds selon DIN 2197

Forma e lunghezza dell'imbocco per maschi secondo la norma DIN 2197

-8			Longueur d'entrée 6 - 8 filets; pour rainures droites	Lunghezza d'imbocco 6 - 8 filetti; per scanalature diritte
.20 - 4			Longueur d'entrée 3.5 - 5.5 filets; pour rainures droites avec entrée à hélice	Lunghezza d'imbocco 3.5 - 5.5 filetti; per scanalature diritte con imbocco corretto
-3			Longueur d'entrée 2 - 3 filets; pour rainures droites et hélicoïdales	Lunghezza d'imbocco 2 - 3 filetti; per scanalature diritte e elicoidali
-4			Longueur d'entrée 3.5 - 5 filets; pour rainures droites et hélicoïdales	Lunghezza d'imbocco 3.5 - 5 filetti; per scanalature diritte e elicoidali
-5			Longueur d'entrée 1.5 x 2 filets; pour rainures droites et hélicoïdales	Lunghezza d'imbocco 1.5 - 2 filetti; per scanalature diritte e elicoidali

Cônes et longueurs coniques pour les tarauds à refouler selon la norme DIN 2175

Forma e lunghezza dell'imbocco per i maschi a rullare secondo la norma DIN 2175

-3			Longueur du cône de formage 2 - 3 filets	Lunghezza d'imbocco 2 - 3 filetti
-5			Longueur du cône de formage 1.5 - 2 filets	Lunghezza d'imbocco 1.5 - 2 filetti

GÉOMETRIES DE COUPE DC – GEOMETRIA DI TAGLIO DC

N



Pour matières normales
(aciers de décolletage; aciers de construction ou de cémentation; aciers au carbone; aciers alliés < 850 N/mm²; aciers inoxydables, soufrés; fonte à graphite sphéroïdale; laiton copeaux longs; Al allié < Si 10%)

Per materiali normali
(acciai da tornitura; acciai da costruzione da cementazione; acciai al carbonio; accia legati < 850 N/mm²; acciai inox, allo zolfo; ghisa grafitica sferoidale e malleabile; ottone (trucioli lunghi); leghe di alluminio Si < 10%)

W



Pour des matières tendres
(aluminium non allié; aluminium faiblement allié; matières thermoplastiques)

Per materiali teneri
(alluminio non legato; alluminio a bassa lega, materie termoplastiche)

Z



Pour des matières tenaces
(matériaux résistants à la rouille et aux acides - austénitiques; ferritiques et martensitiques < 850 N/mm²; titane pur; alliage de nickel 1 < 850 N/mm²; cuivre pur)

Per materiali tenaci
(materiali resistenti alla ruggine e agli acidi - acciai inox austenitici; acciai ferritici e martensitici < 850 N/mm²; titanio puro; leghe di nickel 1 < 850 N/mm²; rame puro)

**ZX
NEW**



Pour les alliages ALU-BRONZE
(AMPCO® 21 / 22)

Per leghe ALU-BRONZE
(AMPCO® 21 / 22)

H



Pour des matières à haute résistance > 850 - < 1'400 N/mm²
(aciers alliés, aciers trempés - aciers haute résistance); **laiton, bronze à copeaux courts; laiton sans plomb; matières duroplastiques, matières plastiques renforcées par des fibres de verre)**

Per materiali ad alta resistenza > 850 - < 1'400 N/mm²
(acciai legati, acciai temprati - acciai ad alta resistenza); **ottone, bronzo (trucioli corti); ottone senza piombo; materie termoindurenti; materie plastiche rinforzate con fibra di vetro)**

S



Pour des alliages spéciaux > 850 - < 1'150 N/mm²
(aciers alliés / traités; aciers ferritiques et martensitiques; alliage de nickel 2)

Per leghe speciali > 850 - < 1'150 N/mm²
(acciai legati / trattati; acciai ferritici e martensitici; leghe di nickel 2)

SA AERO
SA.20 / SA.50



Pour des alliages spéciaux > 850 - < 1'150 N/mm²
(alliage de nickel 2; laiton sans plomb)

Per leghe speciali > 850 - < 1'150 N/mm²
(leghe di nickel 2; ottone senza piombo)

GÉOMETRIES DE COUPE DC — GEOMETRIA DI TAGLIO DC

SA AERO
SA.90



Pour des alliages spéciaux
> 1'150 - < 1'600 N/mm²
(alliage de nickel 3)

Per leghe speciali
> 1'150 - < 1'600 N/mm²
(leghe di nickel 3)

TL



Pour des alliages de titane

Per leghe di titanio

GG



Pour de la fonte grise; de la fonte d'aluminium à forte teneur en Si; des alliages de magnésium

Per ghisa grigia; fusioni di alluminio ad alto contenuto di Si; leghe di magnesio

K



Avec une géométrie spéciale "brise-copeaux"
(pour les matériaux normaux et facilement usinables jusqu'à 1'150 N/mm²; laiton sans plomb)

Con speciale "geometria rompitruciolo"
(per materiali normali, facilmente lavorabili fino a 1'150 N/mm²; ottone senza piombo)

QTAP
NEW



L'ALLROUNDER DC
(pour l'usinage de matériaux universels jusqu'à 1'150 N/mm², pour une utilisation dans les mandrins à compensation axiale et le taraudage synchrone)

L'ALLROUNDER DC
(per la lavorazione di materiali universali fino a 1'150 N/mm², per l'impiego nei mandrini con compensazione assiale e maschiatura sincrona)

RTS



Tarauts DC synchro type RTS
(pour l'usinage de matériaux universels jusqu'à 1'150 N/mm², pour le taraudage synchrone "Rigid Tapping")

Maschio Synchro DC tipo RTS
(per la lavorazione universale di materiali fino a 1'150 N/mm², per maschiatura sincrona "Rigid Tapping")

FS
< Ø 3 mm



Tarauts à refouler DC type FS
(tarauts à refouler universel à 4 lobes pour petits filetages de Ø ≥ 1 - < 3 mm, pour toutes les matières déformables à froid)

Maschio a rullare DC tipo FS
(maschio a rullare universale a 4 lobi per piccole filettature da Ø ≥ 1 - < 3 mm per tutti i materiali deformabili a freddo)

GÉOMETRIES DE COUPE DC — GEOMETRIA DI TAGLIO DC

FPS
≥ Ø 3 mm



Tarauts à refouler DC type FPS
(pour Ø ≥ 3 mm, avec lobes de contact arrondis, conçus pour un fluage progressif de matières à faible coefficient d'allongement (aciers de construction, au carbone, alliés, laiton à copeaux longs, aluminium, etc.))

Maschio a rullare DC tipo FPS
(per Ø ≥ 3 mm, con lobi di contatto arrotondati, concepiti per uno scorrimento progressivo dei materiali con debole coefficiente d'allungamento (acciai da costruzione, al carbonio, legati, ottone a trucioli lunghi, alluminio, ecc))

FAS
≥ Ø 3 mm

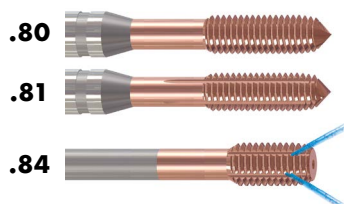

Tarauts à refouler DC type FAS
(pour Ø ≥ 3 mm, avec lobes de contact saillants, conçus pour un fluage rapide de matières tenaces à haut coefficient d'allongement (aciers inoxydables, cuivre pur, etc.))

Maschio a rullare DC tipo FAS
(per Ø ≥ 3 mm, con lobi di contatto sporgenti, concepiti per uno scorrimento rapido dei materiali tenaci ad alto coefficiente d'allungamento (acciai inox, rame puro, ecc))



Filets alternés
(pour moins de génération de chaleur)

Filetti alternati
(per una minore generazione di calore)



Filets tronqués
(pour éviter des coincements de copeaux et des cassures de dents dans la partie guide fileté)

Filetti rastremati
(per evitare l'inzeppamento dei trucioli e la rottura dei denti nel filetto di guida)



Filets tronqués et lubrification intérieure avec sortie frontale

Filetti rastremati e lubrificazione interna con uscita frontale

TRAITEMENTS DE SURFACE ET REVÊTEMENTS POUR TARAUDS ET TARAUDS À REFOULER DC — TRATTAMENTI DI SUPERFICIE E RIVESTIMENTI PER MASCHI E MASCHI A RULLARE DC



Traitement de surface DC "V"

Traitement à la vapeur

Le traitement de surface DC "V" améliore le glissement du taraud et évite la formation de soudures froides.

Trattamento di superficie DC "V"

Vaporizzazione

Il trattamento di superficie DC "V" migliora lo scorrimento del maschio ed evita la formazione di saldature fredde.



Nitruration Plasma + traitement de surface "V"

Les tarauds nitrurés au plasma ont une dureté de surface plus élevée, environ 1100 HV, et sont préconisés pour l'usinage de matériaux abrasifs (fonte grise, fonte d'aluminium à forte teneur en Si). Ils ont également des propriétés de glissement améliorées grâce au traitement de surface supplémentaire DC "V".

Nitrurazione Plasma + trattamento superficiale "V"

I maschi nitrurati al plasma hanno una durezza superficiale maggiore, circa 1100 HV, e sono particolarmente consigliati per la lavorazione di materiali abrasivi (ghisa grigia, alluminio fuso ad alto contenuto di Si). Hanno anche proprietà di scorrimento migliorate grazie al trattamento superficiale aggiuntivo DC "V".



Revêtement DLC

Les outils de filetage revêtus de DLC ont une dureté de surface de environ 2500 HV et sont particulièrement adaptés à l'usinage des métaux non ferreux et d'aluminium à faible teneur en silicium (< 9% Si).

Rivestimento DLC

Gli utensili per filettatura rivestiti in DLC hanno una durezza superficiale di ca. 2500 HV, e sono particolarmente adatti alla lavorazione di metalli non ferrosi e di alluminio con una bassa percentuale di silicio (< 9 % Si).



Revêtement au nitruure de titane (TiN)

La dureté du revêtement au titane est env. de 2400 HV. Les tarauds revêtus avec du titane sont conseillés pour l'usinage des matières abrasives ainsi que les matières provoquant la formation de soudures froides. Permet d'augmenter les vitesses de coupe ainsi que la durée de vie du taraud.

Rivestimento al nitruo di titanio (TiN)

La durezza del rivestimento al titanio è di ca. 2400 HV. I maschi rivestiti al titanio sono consigliati per la lavorazione di materiali abrasivi nonché di materiali che provocano la formazione di saldature fredde. Questo trattamento permette di aumentare la velocità di taglio nonché la durata del maschio.



Revêtement au carbonitruure de titane (TiCN)

La dureté du revêtement TiCN est env. de 3000 HV. Bénéficie d'une plus grande dureté que les tarauds revêtus au TiN, ce qui permet de travailler avec des vitesses de coupe supérieures.

Rivestimento al carbonitruo di titanio (TiCN)

La durezza del rivestimento TiCN è di ca. 3000 HV. Ha una maggiore durezza rispetto ai maschi rivestiti al TiN e questo consente di lavorare con velocità di taglio superiori.

TRAITEMENTS DE SURFACE ET REVÊTEMENTS POUR TARAUDS ET TARAUDS À REFOULER DC — TRATTAMENTI DI SUPERFICIE E RIVESTIMENTI PER MASCHI E MASCHI A RULLARE DC



VS

Protection contre l'usure "VS" pour utilisation générale

Traitement de surface spécifique pour l'utilisation dans les Inox avec les tarauds de la classe de performance "Z" avec émulsion; dans les alliages spéciaux avec des tarauds de la classe "S"; dans les alliages de titane avec des tarauds de la classe "TL".

Protezione antiusura "VS" per uso generale

Rivestimento superficiale specifico per la lavorazione dell'Inox con maschi tipologia "Z" con emulsione; nelle leghe speciali con maschi tipologia "S"; nelle leghe di titanio con maschi della tipologia "TL".



VX

Protection "VX" pour aciers inoxydables et alliages de nickel

Traitement de surface spécifique, particulièrement adapté aux tarauds de la classe de performance "Z", parfaitement adapté à l'usinage avec émulsion des aciers inoxydables et des alliages de nickel.

Protezione antiusura "VX" per acciai inossidabili e leghe di nickel

Rivestimento superficiale specifico particolarmente adatto per maschi tipologia "Z", adattato in modo ottimale alla lavorazione con emulsione di acciai inossidabili e leghe di nickel.

Remarque

Nos revêtements standards permettent de travailler une large gamme de matériaux. Pour des applications spécifiques dans des matériaux particuliers, nous serons heureux de vous proposer le revêtement le plus approprié. Délai de livraison et prix sur demande.

Nota

I nostri rivestimenti standard consentono la lavorazione di un'ampia gamma di materiali. Per applicazioni particolari nei materiali molto specifici, saremo lieti di offrirvi il rivestimento più adatto. Tempi di consegna e prezzo su richiesta.

NEW

AERO



MJ UNJC - UNJF

S320VS-4



S370VX-3



MJ UNJC - UNJF

SA320-4



SA350-3



SA390-3



MJ UNJC - UNJF

TL351VS-3



ZX



Pour les alliages **ALU-BRONZE** (AMPCO® 21/22)
Per leghe **ALLUMINIO-BRONZO** (AMPCO® 21/22)

M

ZX320-4

ZX420-4



QTAP



L'Allrounder DC
L'Allrounder DC

M - MF - UNC UNF - G

Q320VS-4 Q420VS-4



Q323VS-4 Q423VS-4

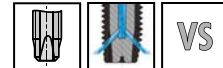

Q360VS-3 Q460VS-3



Q363VS-3 Q463VS-3



TABELLE D'UTILISATION DC ÉLARGIE TABELLA D'IMPIEGO DC INGRANDITA

*** 17** Aciers améliorés > 44 - ≤ 54 HRC
Acciai bonificati > 44 - ≤ 54 HRC
> 44 - ≤ 54 HRC

*** 18** Aciers trempés > 54 - ≤ 63 HRC
Acciai temprati > 54 - ≤ 63 HRC
> 54 - ≤ 63 HRC

64 Laiton sans plomb (ECOBASS®)
Ottone senza piombo (ECOBASS®)
CuZn21Si3P
(ECOBASS®)
CuZn35
CuZn42

* Voir notre programme DC pour fraises à fileter et tourbillonneurs en carbure monobloc selon le catalogue DC TM.1.
* Vedi il nostro programma frese per filettature e frese a filettare vorticoso in metallo duro integrale secondo il catalogo DC TM.1.

NEW

RTS



M 7GX

RTS362VS-3

RTS462VS-3



NP



M

NP110-1 NP210-1

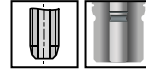

NP110-2 -3 NP210-2 -3



H.TC



MF - UNC - UNF

H320TC-4 H420TC-4



H350TC-3 H450TC-3



SUR DEMANDE

- *Pour des applications spécifiques selon les besoins du client :*
Tarauts à machine DC type MEGA (Ø 42 - 164 mm)
- *Tarauts à machine DC en carbure monobloc pour une plus longue durée de vie de l'outil et une plus grande fiabilité des processus dans des applications spécifiques.*

SU RICHIESTA

- *Per un uso specifico in base alle esigenze del cliente:*
Maschi a macchina tipo MEGA (Ø 42 - 164 mm)
- *Maschi a macchina in metallo duro integrale per una maggiore durata e una maggiore affidabilità di processo in applicazioni specifiche.*



AMÉLIORATIONS TECHNIQUES : PASSAGE À LA NOUVELLE VERSION EN COURS — MIGLIORAMENTI TECNICI: IN CORSO IL PASSAGGIO ALLA NUOVA VERSIONE

LUBRIFICATION INTÉRIEURE AVEC SORTIES RADIALES À 45° LUBRIFICAZIONE INTERNA CON USCITE RADIALI A 45°



M

RTS323VS-4 RTS423VS-4
RTS523VS-4 RTS623VS-4
FPS384VS-3 FPS484VS-3
FPS584VS-3 FPS684VS-3
FAS384VS-3 FAS484VS-3
FAS584VS-3 FAS684VS-3



AVEC NOUVEAU CONDITIONNEMENT DES ARÊTES DE COUPE CON UN NUOVO CONDIZIONAMENTO DEI TAGLIENTI



M - MF - UNC - UNF G - EG UNC - EG UNF

Z370VS-3 Z470VS-3

M

Z373VS-3 Z473VS-3



M - MF - UNC - UNF EG M - EG UNC - EG UNF

SA320-4 SA420-4
SA350-3 SA450-3

M - MF - UNC - UNF EG M - EG UNF

SA390-3



M

TL320VS-4 TL420VS-4

M - MF - UNC - UNF EG M - EG UNC - EG UNF

TL351VS-3 TL451VS-3

MJ - UNJC - UNJF S370VX-3 S470VX-3

COMING SOON:

Tarauts retravaillés H.20TC-4 / H.50TC-3 - nouveau revêtement VH pour augmenter la durée de vie de l'outil jusqu'à 50%, pour matières selon groupes 15 et 16 de notre table de utilisation.

COMING SOON:

Maschi di rilavorazione H.20TC-4 / H.50TC-3 - nuovo rivestimento VH per aumentare la durata dell'utensile fino al 50 %, per materiali secondo i gruppi 15 e 16 della nostra tabella d'impiego.

**TARAUDS, REFOULEURS ET JAUGES NANO
MASCHI A MACCHINA, MASCHI A RULLARE E CALIBRI FILETTATI NANO**

**M / MF / UNC / UNF
S / SF / SL**

Ø 0.3 - Ø 2.74 mm



CODIFICATION – CODIFICAZIONE



Exemple - Esempio



Matières normales	Materiali normali	N							
Matières tendres	Materiali teneri	W							
Matières tenaces	Materiali tenaci	Z							
Alliages Alu-bronze	Leghe Alluminio-bronzo	ZX							
Matières à haute résistance	Materiali ad alta resistenza	H							
Alliages spéciaux	Leghe speciali	S							
Alliages spéciaux (Aero)	Leghe speciali (Aero)	SA							
Alliages de titane (Aero)	Leghe di titanio (Aero)	TL							
Fonte grise et fonte alu	Ghisa grigia e ghisa alluminio	GG							
Allrounder	Allrounder	QTAP							
Taradage synchrone	Maschiatura sincrona	RTS							
Brise-coqueaux	Rompi trucioli	K							
MEGA dimensions	Dimensioni MEGA	MA							
Exécution spéciale	Esecuzione speciale		3						
DIN courte - queue renforcée	DIN corto - gambo rinforzato			1					
DIN courte - queue passante	DIN corto - gambo passante			2					
DIN longue - queue renforcée	DIN lungo - gambo rinforzato			3					
DIN longue - queue passante	DIN lungo - gambo passante			4					
DIN extra-longue - queue renforcée	DIN extra-lungo - gambo rinforzato			5					
DIN extra-longue - queue passante	DIN extra-lungo - gambo passante			6					
Selon norme d'usine	Secondo norma DC			9					
ISO courte - queue renforcée	ISO corto - gambo rinforzato			11					
ISO courte - queue passante	ISO corto - gambo passante			12					
Goujures droites	Scanalature diritte				1				
Goujures droites, entrée à hélice	Scanalature diritte, imbocco corretto				2				
Entrée à hélice	Imbocco corretto				3				
Goujures hélicoïdales < 27° à gauche	Scanalature elicoidali < 27° a sinistra				4				
Goujures hélicoïdales < 27° à droite	Scanalature elicoidali < 27° a destra				5				
Goujures hélicoïdales > 27° à droite	Scanalature elicoidali > 27° a destra				6				
Goujures hélicoïdales > 40° à droite	Scanalature elicoidali > 40° a destra				7				
Goujures hélicoïdales 10°, entrée à hélice	Scanalature elicoidali 10°, imbocco corretto				9				
Exécution standard	Esecuzione standard					0			
Filets alternés	Filetti alternati					1			
Filets tronqués	Filetti rastremati					2			
Canal de lubrification	Canale di lubrificazione					3			
Filets alternés, canal de lubrification	Filetti alternati, canale di lubrificazione					4			
Filets tronqués, canal de lubrification	Filetti rastremati, canale di lubrificazione					5			
Traitement de surface DC "V"	Trattamento di superficie DC "V"						V		
Protection "VS" pour utilisation générale	Protezione antiusura "VS" per uso generale						VS		
Protection "VX" pour aciers inox.et all.de nickel	Protezione antiusura "VX" per acci.inoss.e leg.di nickel						VX		
Revêtu au nitrure de titane (TiN)	Rivestimento al nitruro di titanio (TiN)						TN		
Revêtu au carbonitruro de titane (TiCN)	Rivestimento al carbonitruro di titanio (TiCN)						TG		
Nituration Plasma + traitement de surface "V"	Nitrazione Plasma+trattamento superficiale "V"						NV		
Revêtement DLC	Rivestimento DLC						DL		
Ebaucheur	Sgrossatore							-1	
Intermédiaire	Intermedio							-2	
Finisseur / 2 - 3 filets d'entrée	Finitore / 2 - 3 filetti d'imbocco							-3	
3.5 - 5.5 filets d'entrée, entrée à hélice	3.5 - 5.5 filetti d'imbocco, imbocco corretto							-4	
1.5 - 2 filets d'entrée	1.5 - 2 filetti d'imbocco							-5	
6 - 8 filets d'entrée	6 - 8 filetti d'imbocco							-8	
Jeu de tarauds	Serie di maschi							-S	

PICTOGRAMMES – SIMBOLI



Pour groupes matières selon table de utilisation .
Per gruppi di materiali secondo tabella d'impiego .

12	
1.0037	Si37-2 (S235JR)
1.0050	Si50-2 (E295)
1.0060	Si60-2 (E335)
1.5919	15CrNi6
1.7131	16MnCr5

22	
1.4301	X5CrNi18-10
1.4406	X2CrNiMoN17-12-2
1.4435	X2CrNiMo18-14-3
1.4541	X6CrNiTi18-10
1.4571	X6CrNiMoTi17-12-2

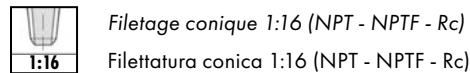
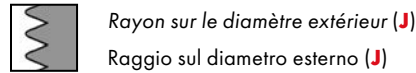
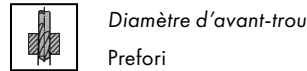
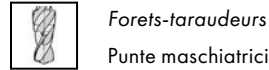
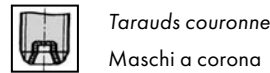
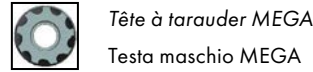
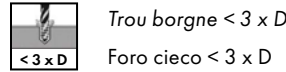
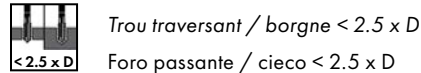
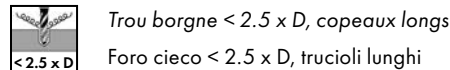
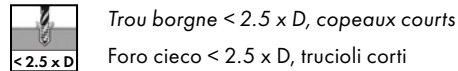
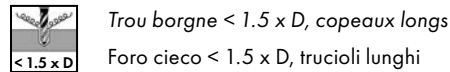
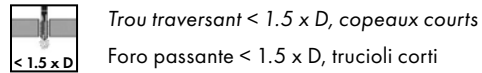
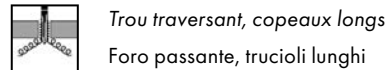
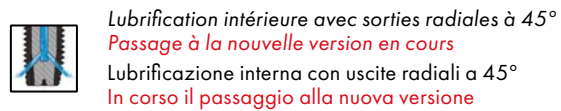
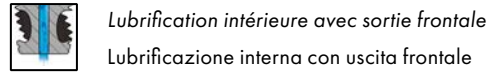
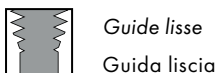
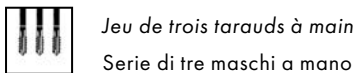
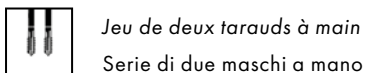
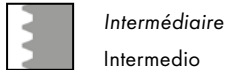
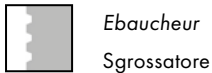
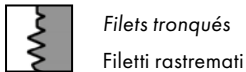
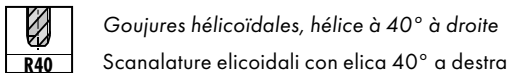
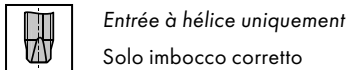
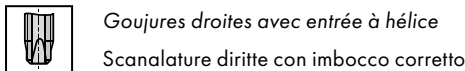
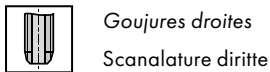
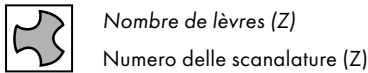
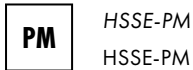
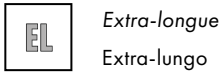
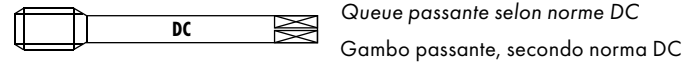
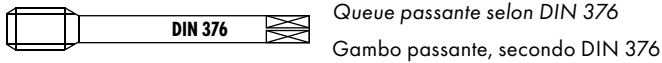
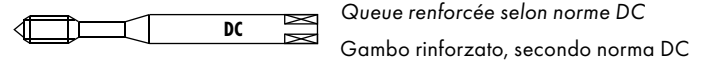
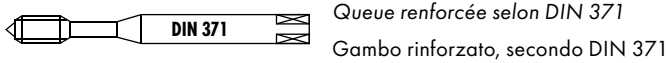

PICTOGRAMMES — SIMBOLI



Filetage à gauche
Filettatura sinistra



3.5 - 5.5 filets d'entrée, forme B
3.5 - 5.5 filetti d'imbocco, forma B



2 - 3 filets d'entrée, forme C
2 - 3 filetti d'imbocco, forma C



1.5 - 2 filets d'entrée, forme E
1.5 - 2 filetti d'imbocco, forma E



Classe de tolérance ISO 2 6H
Classe di tolleranza ISO 2 6H



Classe de tolérance ISO 2 6H + 0.1 mm
Classe di tolleranza ISO 2 6H + 0.1 mm



Classe de tolérance ISO 3 6G
Classe di tolleranza ISO 3 6G



Traitement de surface DC "V"
Trattamento di superficie DC "V"



Protection contre l'usure "VS" pour utilisation générale
Protezione antiusura "VS" per uso generale



Protection "VX" pour aciers inoxydables et alliages de nickel
Protezione antiusura "VX" per acciai inossidabili e leghe di nickel



Revêtement au nitrure de titane
Rivestimento al nitruro di titanio



Revêtement au carbonitrure de titane
Rivestimento al carbonitruro di titanio



Nitruration Plasma + traitement de surface "V"
Nitrazione Plasma + trattamento superficiale "V"



Revêtement DLC
Rivestimento DLC



Revêtement Hardlube
Rivestimento Hardlube



Copeaux fragmentés / Copeaux consistants
Frammenti di trucioli / Trucioli consistenti



Pour taraudage synchrone
Per maschiatura sincrona



Pour taraudage classique
Per maschiatura classica



Article en stock
Articoli in stock



Disponible à court terme
Disponibile a breve



Disponible jusqu'à épuisement du stock
Articoli disponibili sino ad esaurimento

CLASSIFICATION DES MATIÈRES

Exemples pratiques de classification des matières

Référence : DIN

11	Aciers de décolletage
1.0711	A11
1.0715	A15X
1.0718	A20
1.0726	A30
1.0737	A35

12	Aciers de construction ou de cémentation
1.0037	Cr1nc
1.0050	Cr5nc
1.0060	Cr6nc
1.5919	12XH2A
1.7131	18XT

13	Aciers au carbone
1.0503	45
1.0535	50
1.0601	60
1.1545	Y10A
1.2067	9X2

14	Aciers alliés < 850 N/mm ²
1.2363	X6BΦ
1.3551	1X10
1.7218	38XC
1.7220	35XM
1.7225	38XM

15	Aciers alliés / traités > 850 - < 1150 N/mm ²
1.3553	1X15CT
1.6580	3X3M3Φ
1.7220	35XM
1.7225	38XM
1.8507	38X2MHOA

16	Aciers haute résistance ≤ 44 HRC
1.6582	38X2H2MA
1.7225	38XM
1.7228	38XB
1.8515	40XH

17	Aciers améliorés > 44 - ≤ 54 HRC
> 44 - ≤ 54 HRC	

18	Aciers trempés > 54 - ≤ 63 HRC
> 54 - ≤ 63 HRC	

21	Aciers inoxydables, soufrés
1.4005	08X13
1.4104	12X13
1.4305	14X17H2

22	Austénitiques
1.4301	08X18H10T
1.4406	03X16H15M3
1.4435	03X17H14M3
1.4541	12X18H10T
1.4571	10X17H13M2T

23	Ferritiques et martensitiques < 850 N/mm ²
1.4112	14X17H2
1.4540	18X11MHΦБ
1.4582	40X10C2M
1.4762	15X28
1.4922	20X12BHMMΦЛ

24	Ferritiques et martensitiques > 850 - < 1150 N/mm ²
1.4057	20X17H2
1.4125	95X18
1.4542	18X15H3M-Ш
1.4548	55X20Г9AH4
1.4748	20X20H14C2

31	Fonte grise
0.6015	C415
0.6020	C420
0.6025	C425
0.6030	C430

32	Fonte à graphite sphéroïdale et malléable
0.7040	B440
0.7043	B450
0.7050	B460
0.7060	B470
0.7080	B480

41	Titane pur
3.7024	BT1-00
3.7034	BT1-0
3.7055	BT1-1
3.7065	BT1-2

42	Alliage de titane
3.7124	BT23
3.7164	BT5-1
3.7174	BT6

51	Alliage de nickel 1 ≤ 850 N/mm ²
1.3912	36H
2.4360	HMu2
2.4816	HMu5
1.4876	XH32T

52	Alliage de nickel 2 > 850 - ≤ 1150 N/mm ²
2.4375	XH77T10P
2.4631	XH67MBT10
2.4668	XH75MBT10

53	Alliage de nickel 3 > 1150 - ≤ 1600 N/mm ²
2.4631	XH35BT10
2.4668	XH70BMT10

61	Cuivre pur (électrolytique)
2.0060	M1

62	Laiton, bronze (copeaux courts)
2.0401	ЛЦ40С
2.0402	ЛС59-1
2.1030	БрОФ8-0.3
2.1096	БрОФ7-0.2

63	Laiton (copeaux longs)
2.0240	Л63
2.0265	Л70
2.0321	Л90

64	Laiton sans plomb
	CuZn21Si3P (ECOBASS®)
	CuZn35
	CuZn42

71	Al non allié
3.0205	A98
3.0255	A99

72	Al allié Si < 1.5 %
3.1255	D16
3.1355	D18
3.2315	D1
3.3206	B95
3.4345	AMr5

73	Al allié Si > 1.5 % - < 10 %
3.2161	AK7
3.2162	AK9
3.2341	AL6
3.2371	AK7ч

74	Al allié Si > 10 %, Alliages de magnésium
3.2381	AK10cy
3.2382	AK12
3.2581	AK12MMrH
3.2583	MPS

81	Matières thermoplastiques
Делрин	
Тетлон	
Нейлон	

82	Matières duroplastiques
Бакелит	
Новопан	

83	Matières plastiques renforcées par fibres
Армированные стеклопластики	
Армированные дюро- и термопластики	

91	Or jaune
2N18	
Au585AgCu205	
3N18	
Au917AgCu44	

92	Or rose
4N18	
5N18	
Au585CuAg325	
Au750AgCu	
Au917Cu83	

93	Or blanc
Au750PdCu125	
Au750PdCu150	
Au585PdCu150	
Au925Pd75	

94	Argent
Ag999	
Ag800Cu	
Ag925Cu	

CLASSIFICAZIONE DEI MATERIALI

Esempi pratici della classificazione dei materiali

Referenze:
AISI/ASTM/UNS

11	Acciai da tornitura
1.0711	1212
1.0715	1213
1.0718	12L13
1.0726	1140
1.0737	12L14

12	Acciai da costruzione / da cementazione
1.0037	1015
1.0050	A570 Gr.50
1.0060	A572 Gr.55
1.5919	4617
1.7131	5115

13	Acciai al carbonio
1.0503	1045
1.0535	1055
1.0601	1060
1.1545	W110
1.2067	L 3

14	Acciai legati < 850 N/mm2
1.2363	A2
1.3551	M50
1.7218	4130
1.7220	4135
1.7225	4140

15	Acciai legati / trattati > 850 - < 1150 N/mm2
1.3553	-
1.6580	4340
1.7220	4135
1.7225	4140
1.8507	A355CLD (K23510)

16	Acciai ad alta resistenza ≤ 44 HRC
EN-GJS-1200-2	
1.6582	4340
1.7225	4140
1.7228	4150
1.8515	-

17	Acciai bonificati > 44 - ≤ 54 HRC
> 44 - ≤ 54 HRC	

18	Acciai temprati > 54 - ≤ 63 HRC
> 54 - ≤ 63 HRC	

21	Acciai inox, allo zolfo
1.4005	416
1.4104	430F
1.4305	303

22	Acciai inox, austenitici
1.4301	304
1.4406	316LN
1.4435	316L
1.4541	321
1.4571	316Ti

23	Ferritici e martensitici < 850 N/mm2
1.4112	440B
1.4540	XM12
1.4582	-
1.4762	446
1.4821	4922

24	Ferritici e martensitici > 850 - < 1150 N/mm2
1.4057	431
1.4125	440C
1.4542	630 (17-4PH)
1.4748	-

31	Ghisa grigia
0.6015	A48-25B
0.6020	A48-30B
0.6025	A48-35B
0.6030	A48-45B

32	Ghisa grafitica sferoidale e malleabile
0.7040	65-45-12
0.7043	60-40-18
0.7050	80-55-06
0.7060	70-60-03
0.7080	120-90-02

41	Titanio puro
3.7024	Gr.1
3.7034	Gr.2
3.7055	Gr.3
3.7065	Gr.4

42	Leghe di titanio
3.7124	Alloy 230
	F-1295
3.7164	Gr.5
3.7174	-

51	Leghe di nickel 1 ≤ 850 N/mm2
1.3912	K93600
2.4360	N04400
2.4816	N06600
1.4876	N08800

52	Leghe di nickel 2 > 850 - < 1150 N/mm2
2.4375	N05500 (B865)
2.4631	N07080 (B637)
2.4668	N07718 (B637)

53	Leghe di nickel 3 > 1150 - ≤ 1600 N/mm2
2.4631	N07080 (B637)
2.4668	N07718 (B637)

61	Rame puro (elettrolitico)
2.0060	C11000

62	Ottone, bronzo (trucioli corti)
2.0401	C38500
2.0402	C37800
2.1030	C52100
2.1096	-

63	Ottone (trucioli lunghi)
2.0240	C23000
2.0265	C26000
2.0321	C27200

64	Ottone senza piombo
CuZn21Si3P (ECOBASS®)	
CuZn35	
CuZn42	

71	Alluminio non legato
3.0205	1200
3.0255	1050A

72	Leghe di alluminio Si < 1.5 %
3.1255	2014
3.1355	2024
3.2315	6082
3.3206	6060
3.4345	7022

73	Leghe di alluminio Si > 1.5 % - < 10 %
3.2161	327
3.2162	-
3.2341	-
3.2371	356

74	Leghe di al. Si > 10 %, Leghe di magnesio
3.2381	A360
3.2382	-
3.2581	A413
3.2583	413.1

81	Materie termoplastiche
Delrin (POM)	
Teflon	
Nylon	

82	Materie termoindurenti
Bakelit	
Novopan	

83	Materie plastiche rinforzate con fibre
Materie plastiche rinforzate con fibra di vetro	

91	Oro giallo
2N18	
Au585AgCu205	
3N18	
Au917AgCu44	

92	Oro rosso
4N18	
5N18	
Au585CuAg325	
Au750AgCu	
Au917Cu83	

93	Oro bianco
Au750PdCu125	
Au750PdCu150	
Au585PdCu150	
Au925Pd75	

94	Argento
Ag999	
Ag800Cu	
Ag925Cu	

TABELLE D'UTILISATION — TABELLA D'IMPIEGO

Taraudage classique Maschiatura classica

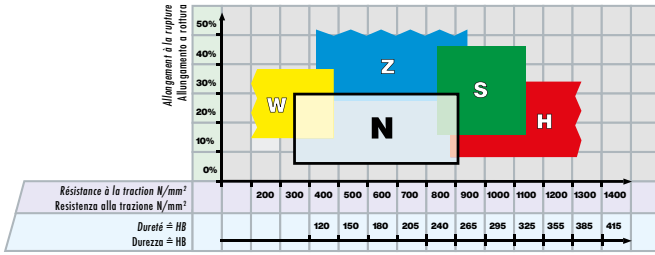

Taraudage classique Maschiatura classica

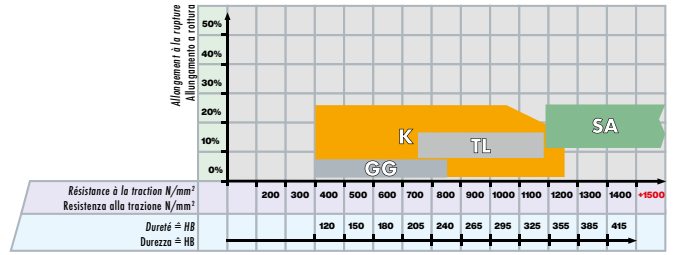

Taraudage classique et synchrone Maschiatura classica e sincrona

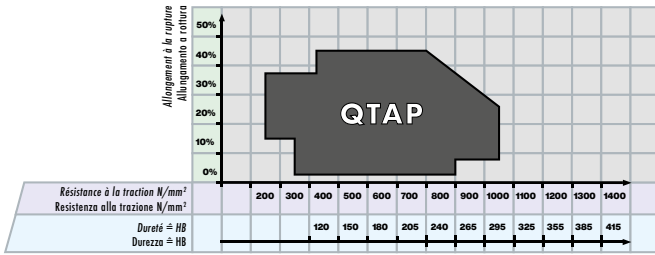

Taraudage synchrone Maschiatura sincrona

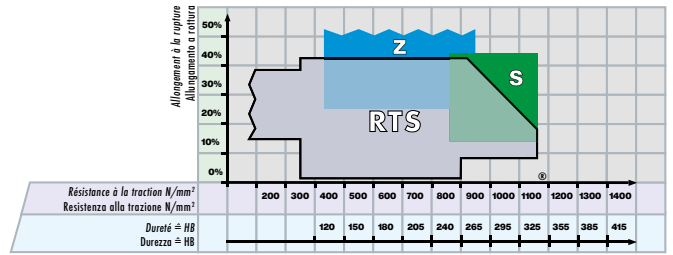

DC Classification des matières

DC Classificazione dei materiali

Groupes de matières Gruppi di materiali	Désignation des matières	Designazione dei materiali	Dureté Durezza (HB)	Résistance Resistenza Rm (N/mm ²)	Allongement Allungamento A (%)
10 Aciers Acciai	11 Aciers de décolletage	Acciai da tornitura	< 200	< 700	< 10
	12 Aciers de construction ou de cémentation	Acciai da costruzione / da cementazione	< 200	< 700	< 30
	13 Aciers au carbone	Acciai al carbonio	< 300	< 1000	< 20
	14 Aciers alliés < 850 N/mm ²	Acciai legati < 850 N/mm ²	< 250	< 850	< 30
	15 Aciers alliés / traités > 850 - < 1150 N/mm ²	Acciai legati / trattati > 850 - < 1150 N/mm ²	> 250	> 850	< 30
	16 Aciers haute résistance ≤ 44 HRC	Acciai ad alta resistenza ≤ 44 HRC	> 250	> 850	< 12
	17 Aciers améliorés > 44 - ≤ 54 HRC	Acciai bonificati > 44 - ≤ 54 HRC	> 410	> 1400	< 2
	18 Aciers trempés > 54 - ≤ 63 HRC	Acciai temprati > 54 - ≤ 63 HRC	> 560	> 1980	< 2
20 Aciers inoxydables Acciai inox	21 Aciers inoxydables, soufrés	Acciai inox, allo zolfo	< 250	< 850	< 25
	22 Austénitiques	Acciai inox, austenitici	< 250	< 850	> 20
	23 Ferritiques et martensitiques < 850 N/mm ²	Ferritici e martensitici < 850 N/mm ²	< 250	< 850	> 20
	24 Ferritiques et martensitiques > 850 - < 1150 N/mm ²	Ferritici e martensitici > 850 - < 1150 N/mm ²	> 250	> 850	> 15
30 Fonte Ghisa	31 Fonte grise	Ghisa grigia	< 250	< 850	< 10
	32 Fonte à graphite sphéroïdale et malléable	Ghisa grafitica sferoidale e malleabile	< 250	< 850	> 10
40 Titane Titanio	41 Titane pur	Titanio puro	< 250	< 850	> 20
	42 Alliage de titane	Leghe di titanio	> 250	> 850	< 20
50 Nickel Nickel	51 Alliage de nickel 1 ≤ 850 N/mm ²	Leghe di nickel 1 ≤ 850 N/mm ²	< 250	< 850	> 25
	52 Alliage de nickel 2 > 850 - ≤ 1150 N/mm ²	Leghe di nickel 2 > 850 - ≤ 1150 N/mm ²	> 250	> 850	< 25
	53 Alliage de nickel 3 > 1150 - ≤ 1600 N/mm ²	Leghe di nickel 3 > 1150 - ≤ 1600 N/mm ²	> 340	> 1150	< 20
60 Cuivre Rame	61 Cuivre pur (électrolytique)	Rame puro (elettrolitico)	< 120	< 400	> 12
	62 Laiton, bronze (copeaux courts)	Ottone, bronzo (trucioli corti)	< 200	< 700	< 12
	63 Laiton (copeaux longs)	Ottone (trucioli lunghi)	< 200	< 700	> 12
	64 Laiton sans plomb	Ottone senza piombo	< 220	< 700	> 15
70 Aluminium Magnésium Alluminio Magnesio	71 Al non allié	Alluminio non legato	< 100	< 350	> 15
	72 Al allié Si < 1.5 %	Leghe di alluminio Si < 1.5 %	< 150	< 500	> 15
	73 Al allié Si > 1.5 % - < 10 %	Leghe di alluminio Si > 1.5 % - < 10 %	< 120	< 400	< 15
	74 Al allié Si > 10 %, alliages de magnésium	Leghe di Al. Si > 10 %, leghe di magnesio	< 120	< 400	< 10
80 Matières plastiques Materie plastiche	81 Matières thermoplastiques	Materie termoplastiche	-	-	-
	82 Matières duroplastiques	Materie termoidurenti	-	-	-
	83 Matières plastiques renforcées par fibres	Materie plastiche rinforzate con fibre	-	-	-
90 Métaux précieux Metalli preziosi	91 Or jaune	Oro giallo	-	-	-
	92 Or rose	Oro rosso	-	-	-
	93 Or blanc	Oro bianco	-	-	-
	94 Argent	Argento	-	-	-

TARAUDAGE CLASSIQUE ET SYNCHRONE MASCHIATURA CLASSICA E SINCRONA



Dès page :
Dalla pagina:

MJ / M

MF

UNJC / UNC / UNC(J)

UNJF / UNF / UNF(J)

UNEF / UN / UNS

G / Rp / Rc / W / SV

NPT / NPTF

PG / TR

EG M / EG UNC / EG UNF

K Brise-copeaux Rompi trucioli	
104	105
142	



K.13TC

K.13VS



QTAP Allrounder Allrounder			
61	106	61	107
143	143	144	144
167	167	168	168
192	192	193	193
210	210	211	211

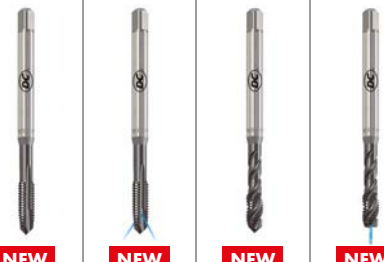

Q.20VS

Q.23VS

Q.60VS

Q.63VS



Vc
(m/min)
Guide Line
Ø 2.8 - 20 mm

20 - 40

20 - 40

16 - 24

16 - 24

6 - 12

20 - 40

6 - 12

6 - 12

4 - 8

20 - 40

20 - 40

6 - 12

4 - 8

12 - 16

25 - 35

20 - 40

20 - 40

20 - 40

20 - 40

20 - 40

20 - 40

20 - 40

16 - 24

8 - 16

20 - 40

12 - 16

12 - 16

12 - 16

12 - 16

12 - 16

	Vc (m/min) Guide Line			
	Ø 5 - 10.9 mm	Ø 11 - 18.9 mm	Ø 19 - 31.9 mm	Ø 32 - 42 mm
11	30 - 40	20 - 30	20 - 30	20 - 30
12	30 - 40	20 - 30	20 - 30	20 - 30
13	30 - 40	20 - 30	20 - 30	20 - 30
14	20 - 30	15 - 25	15 - 25	15 - 25
15	15 - 20	10 - 15	8 - 12	5 - 8
16	8 - 12	5 - 8	5 - 8	5 - 8
17				
18				
21				
22				
23				
24				
31	30 - 40	30 - 40	30 - 40	30 - 40
32	30 - 40	20 - 30	20 - 30	20 - 30
41				
42				
51				
52				
53				
61				
62	30 - 40	30 - 40	30 - 40	30 - 40
63	30 - 40	30 - 40	30 - 40	30 - 40
64	30 - 40	20 - 30	20 - 30	20 - 30
71				
72				
73				
74	30 - 40	30 - 40	30 - 40	30 - 40
81				
82				
83	30 - 40	30 - 40	30 - 40	30 - 40
91				
92				
93				
94				







20 - 40					11
20 - 40					12
16 - 24					13
16 - 24					14
6 - 12					15
					16
					17
					18
20 - 40					21
6 - 12					22
6 - 12					23
4 - 8					24
20 - 40					31
20 - 40					32
					41
					42
6 - 12					51
4 - 8					52
					53
12 - 16					61
25 - 35					62
20 - 40					63
20 - 40					64
20 - 40					71
20 - 40					72
20 - 40					73
20 - 40					74
20 - 40					81
16 - 24					82
8 - 16					83
20 - 40					91
12 - 16					92
					93
12 - 16					94

E Fonctionnelle avec émulsion
Funzionale con emulsione







A Optimale avec air
Ottimale con aria

A Fonctionnelle avec air
Funzionale con aria





REGISTRE — REGISTRO

	<i>Taroudage classique</i> Maschiatura classica		<i>Taroudage classique et synchrone</i> Maschiatura classica e sincrona
MJ S 46 SA 46/47 TL 47 UNJC S 48 SA 48/49 TL 49 UNJF S 50 SA 50/51 TL 51 M N 60/62-85/114-115/118 NP 116-117 W 86-87 Z 88-91 ZX 93 H 94-97 S 98-99 SA 99-101 TL 100-101 GG 102-103 MF N 124-133/146-148 Z 134-135 H 136-137 S 138 SA 139-141 TL 140-141 UNC, UNC(J) N 154-157/170-171 Z 158-160 H 161-162 S 163-164 SA 165-166 TL 165 UNF, UNF(J), UNEF, UN, UNS N 176-179/196-199 Z 180-182 H 184-185 S 186 SA 188-190 TL 188-189 G (BSP), Rp, Rc, W, SV Schaublin N 204-206/213-217 W 207 H 207 GG 207 Z 208-209 NPT, NPTF, PG, TR N 220-223 EG M, EG UNC, EG UNF N 226-227/230/233 Z 231/234 S 234 SA 228-229/232/234-235 TL 228/232/235		M K 104-105 Q 61/106-107 MF K 142 Q 143-144 UNC, UNF Q 167-168 / 192-193 G (BSP) Q 210-211	
			<i>Taroudage synchrone</i> Maschiatura sincrona
		M RTS 108-112 Z.70/Z.73 90-91 MF RTS 145 Z.70 134-135 UNC, UNC(J) RTS 169 Z.70 160 UNF, UNF(J) RTS 194 Z.70 182 G (BSP) RTS 212 Z.70 209 EG UNC, EG UNF Z 231/234	
			<i>Taroudage par déformation</i> Maschiatura per deformazione
	<i>Tarouds couronne</i> Maschi a corona	M FS 254-255 FPS 256-258 FAS 259-261 MF FPS 262 FAS 262 UNC FS 263 FPS 263 FAS 263 UNF FS 264 FPS 264 FAS 264 G (BSP) FPS 265 FAS 265	
M, MF, UN, G (BSP) N 237-239			
	<i>Forets-taraudeurs</i> Punte maschiatrici		
M, MF, UNC, G (BSP), PG N 242-243			

REGISTRE — REGISTRO

	Filières Filiera		Mandrins de taraudage SRT Maschiatore SRT												
M N 272/286/288/289 Z 273/286 Z.LL 273 MF N 274-276/287/288 Z 274-275 UNC N 277 UNF, UNEF, UN, UNS N 278-279 G (BSP), R (DIN EN 10226, ISO 7-1) N 280/282/289 Z 281 MS 281 NPT, NPTF, PG, TR N 283-284 W N 285/289	<table border="0"> <tr> <td>HSK</td><td>306</td><td>BT40</td><td>306</td></tr> <tr> <td>SK40/SK50</td><td>307</td><td>DIN 1835 B</td><td>308-309</td></tr> </table>	HSK	306	BT40	306	SK40/SK50	307	DIN 1835 B	308-309	 Inserts Pinze a cambio rapido	<table border="0"> <tr> <td>S</td><td>310</td><td>SC</td><td>311</td></tr> </table>	S	310	SC	311
HSK	306	BT40	306												
SK40/SK50	307	DIN 1835 B	308-309												
S	310	SC	311												
	Jauges de filetage Calibri filettati	 Accessoires Accessori	Mèches à centrer en carbure monobloc Punte da centro in metallo duro integrale C315VS 318												
M D 294-295 MF D 296-299 UNC D 300 UNF, UNEF D 301 G (BSP), PG D 302 NPT, NPTF D 303 EG M, EG UNC, EG UNF D 304	Mèches en carbure monobloc Punte elicoidali in metallo duro integrale <table border="0"> <tr> <td>FZ315VS</td><td>319</td><td>F313VS</td><td>320</td></tr> <tr> <td>F285VS</td><td>320</td><td>F286VS</td><td>320</td></tr> </table>	FZ315VS	319	F313VS	320	F285VS	320	F286VS	320	Porte-filières Porta-filiera D5810 322	Tourne-à-gauche Giramaschi D5820 322				
FZ315VS	319	F313VS	320												
F285VS	320	F286VS	320												
		Informations techniques Conditions générales de vente Vous trouverez de plus amples informations sous www.dcswiss.com	Informazioni tecniche Condizioni generali di vendita Potete trovare ulteriori informazioni sotto www.dcswiss.com												

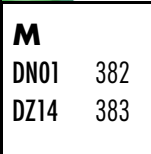
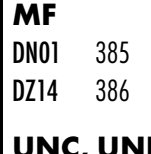
REGISTRE — REGISTRO

	<i>Tarauds à machine nano</i> Maschi a macchina nano		<i>Tarauds machine à refouler nano</i> Maschi a rullare nano	
<p>M TAN 338 TAZ 339 CMS 340</p> <p>MF TAN 341 TAZ 342 CMS 343</p> <p>UNC TAN 344 TAZ 345 CMS 346</p> <p>UNF TAN 347 TAZ 348 CMS 349</p> <p>S TAN 350 TAZ 351 CMS 352</p> <p>SF TAN 353 TAZ 354 CMS 355</p> <p>SL TAN 356 TAZ 357 CMS 358</p>		<p>M FA80 363 FA83 363 CFA80 370 CFA83 370</p> <p>MF FA80 364 FA83 364</p> <p>UNC FA80 365 FA83 365 CFA80 371 CFA83 371</p> <p>UNF FA80 366 FA83 366 CFA80 372 CFA83 372</p> <p>S FA80 367 FA83 367 CFA80 373 CFA83 373</p> <p>SF FA80 368 FA83 368</p> <p>SL FA80 369 FA83 369</p>		
	<i>Jauges de filetage nano</i> Calibri filettati nano	<p>M DN01 382 DN02 382 DZ04 383 DZ14 383 DN04 384 DN14 384</p> <p>MF DN01 385 DN02 385 DZ04 386 DZ14 386 DN04 387 DN14 387</p> <p>UNC, UNF DN01 388 DN02 388 DZ04 389 DZ14 389 DN04 390 DN14 390</p> <p>S NIHS, S NIHS NT DN01 391-392 DN02 391-392 DZ04 393 DZ14 393 DN04 394 DN14 394</p> <p>SF NIHS, SF NIHS NT DN01 395 DN02 395 DZ04 396 DZ14 396 DN04 397 DN14 397</p> <p>SL DN01 398 DN02 398</p>		
<p> <i>Toutes les jauges tampons de filetage nano sont certifiées SCS et le certificat payant est disponible sur commande.</i> Tutti i tamponi filettati nano sono certificati SCS e il certificato a pagamento è disponibile su ordinazione.</p> <p> <i>Toutes les jauges bagues de filetage nano ont un certificat de contrôle, réalisé avec des jauges tampons filetés de contrôle accréditées SCS. Le certificat de contrôle payant est disponible sur commande.</i> Tutti gli anelli di controllo nano hanno un certificato di misura, realizzato utilizzando tamponi di controllo a spina certificati SCS. Il certificato a pagamento è disponibile su ordinazione.</p>			<p><i>Tampons rapporteurs nano</i> <i>Témoins d'usure nano</i> <i>Jauges étalons filetées nano</i></p>	<p><i>Tamponi di controllo a spina nano</i> <i>Testimone di usura nano</i> <i>Campioni filettati nano</i></p>
		<p>M RN05-1 399 RN15-1 399 RN05-2 400 RN15-2 400 RN05-3 401 RN15-3 401</p> <p>MF RN05-1 402 RN15-1 402 RN05-2 403 RN15-2 403 RN05-3 404 RN15-3 404</p> <p>UNC, UNF RN05-1 405 RN15-1 405 RN05-2 406 RN15-2 406</p> <p>S NIHS, S NIHS NT RN05-1 407 RN15-1 407 RN05-2 408 RN15-2 408</p> <p>SF NIHS, SF NIHS NT RN05-1 409 RN15-1 409 RN05-2 410 RN15-2 410</p> <p>S NIHS EN00 411</p>		

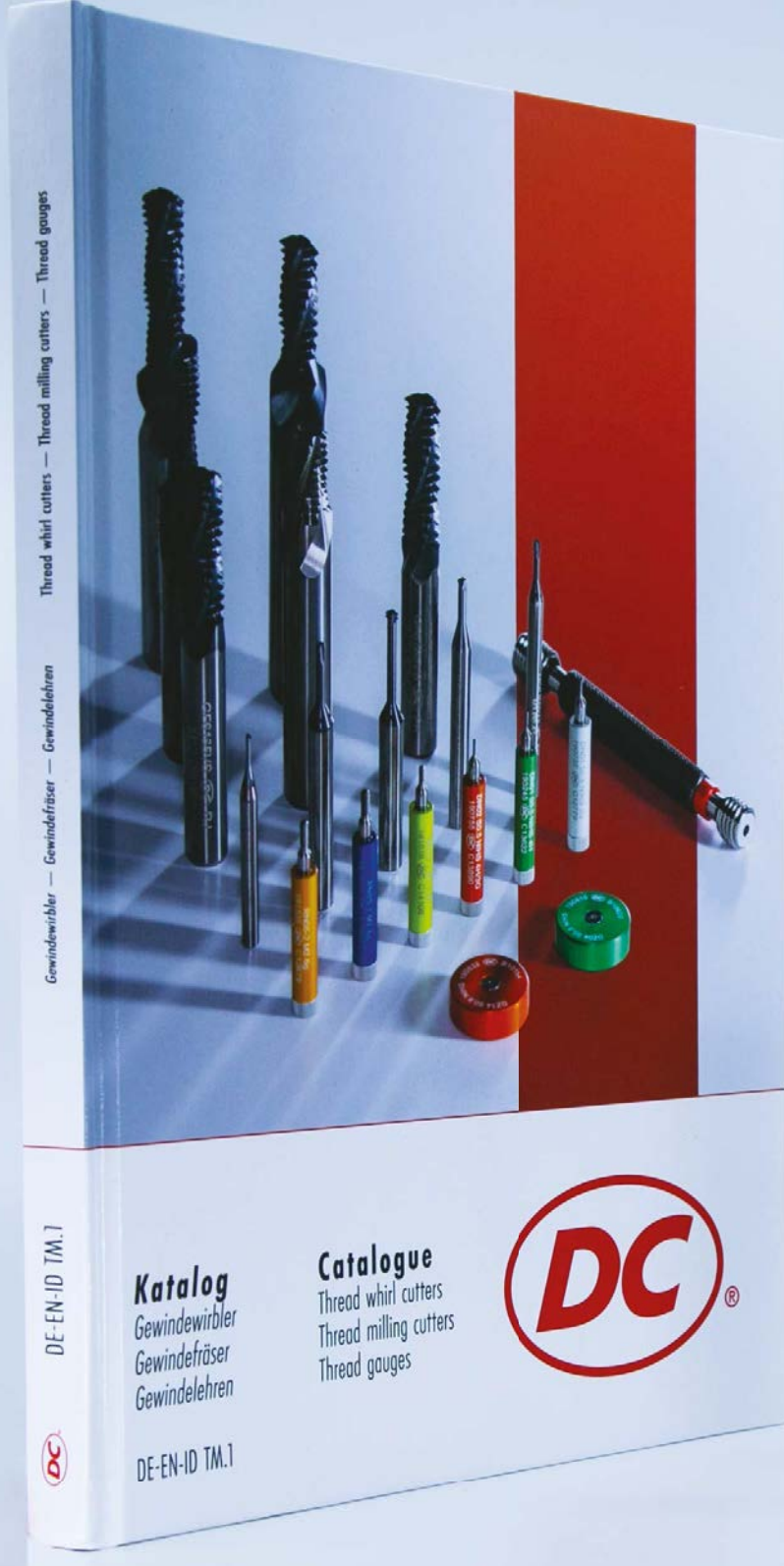













**POUR LES FRAISES À FILETER ET LES TOURBILLONNEURS
EN CARBURE MONOBLOC, VEUILLEZ DEMANDER NOTRE
CATALOGUE TM !**

**PER LE FRESE A FILETTARE E LE FRESE A FILETTARE VORTICO-
SO IN METALLO DURO INTEGRALE CHIEDERE IL NOSTRO
CATALOGO TM!**

MJ, UNJC, UNJF

Répertoire — Tarands à machine MJ ISO 5855, UNJC / UNJF ISO 3161/ASME B1.15

Rubrica — Maschi a macchina MJ ISO 5855, UNJC / UNJF ISO 3161/ASME B1.15

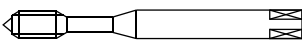
				S		SA	
Caractéristiques Caratteristiche				 VS	 R45 VX		 R15
				 NEW	 NEW	 NEW	 NEW
Genre de trou Tipo di foro							
				S320VS-4	S370VX-3	SA320-4	SA350-3
MJ 4H6H /4H5H	ISO 5855	<i>DIN longue</i> DIN lungo	DIN 371	46	46	47	47
UNJC 3B	ISO 3161/ASME B1.15	<i>DIN longue</i> DIN lungo	DIN 371	48	48	49	49
UNJF 3B	ISO 3161/ASME B1.15	<i>DIN longue</i> DIN lungo	DIN 371	50	50	51	51



Composites
GWi3067VX



Super alloys
SA390-3



Titanium alloys
TL351VS-3

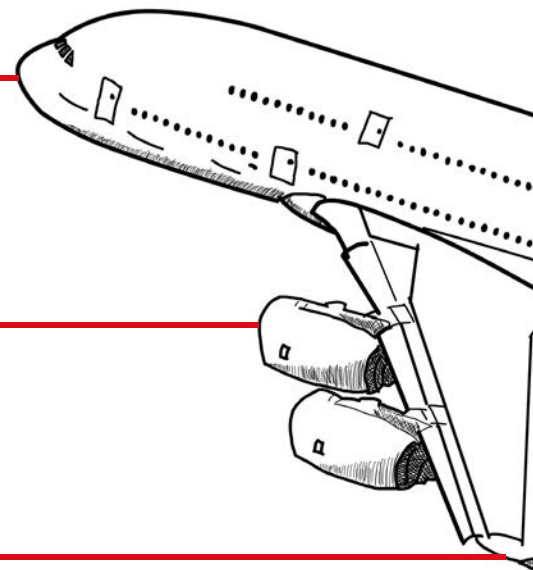

MJ, UNJC, UNJF

Répertoire — Tarauts à machine MJ ISO 5855, UNJC / UNJF ISO 3161/ASME B1.15
 Rubrica — Maschi a macchina MJ ISO 5855, UNJC / UNJF ISO 3161/ASME B1.15

SA	TL
 R10	 R15  VS
 NEW	 NEW
	
SA390-3	TL351VS-3
46	47
48	49
50	51

Aluminium alloys
W360DL-3

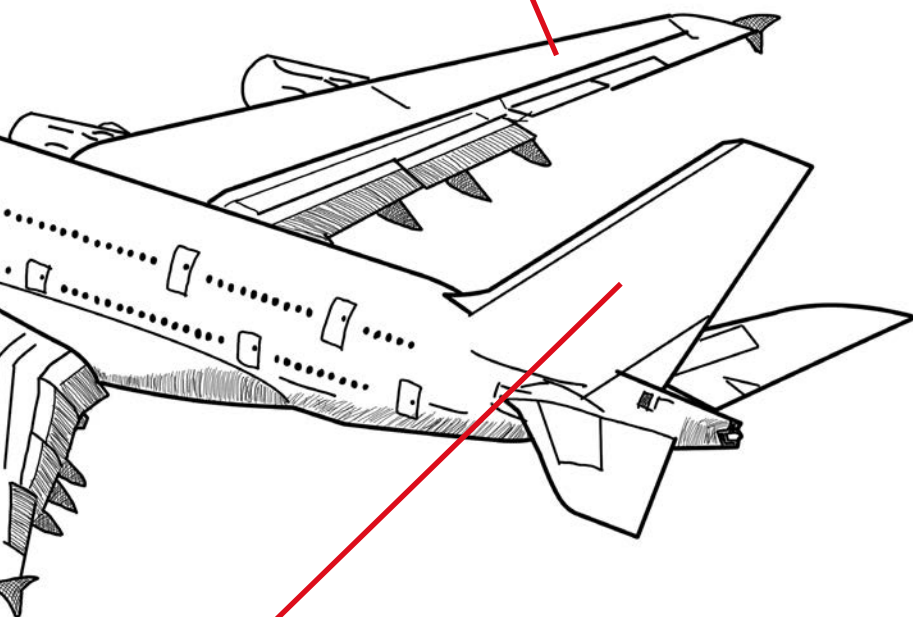

Glass fibre reinforced plastics
H350TC-3



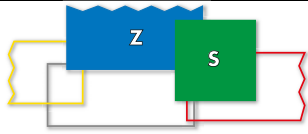
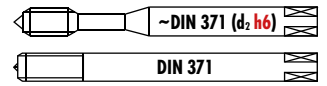
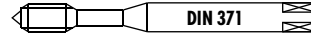

S320VS-4

S370VX-3

S320VS-4 **S370VX-3** **SA390-3**



aero

SA390-3

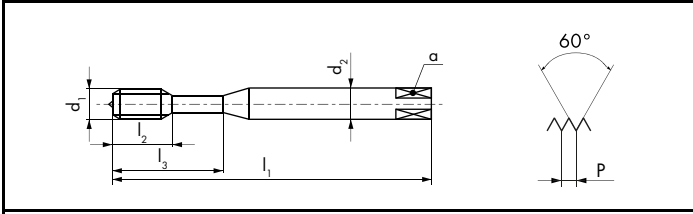

B 4 x P **C** 2.5 x P **C** 2.5 x P

4H5H **4H5H** **4H5H**

$\emptyset d_1$ MJ	P mm	l_1 mm	l_2 mm	l_3 mm	d_2 mm	a mm			ID
3	0.5	56	12	18	3.5	2.7	3	2.55	● 198966
4	0.7	63	14	21	4.5	3.4	3	3.4	● 198967
5	0.8	70	15	25	6	4.9	3	4.3	● 198968
6	1	80	17	30	6	4.9	3	5.1	● 198969
8	1	90	20	35	8	6.2	3	7.1	● 198970
8	1.25	90	20	35	8	6.2	3	6.9	● 198971
10	1.25	100	22	39	10	8	3	8.9	● 198972
10	1.5	100	22	39	10	8	3	8.6	● 198973

$\emptyset d_1$ MJ	P mm	l_1 mm	l_2 mm	l_3 mm	d_2 h6 mm	a mm			ID
3	0.5	56	5.5	18	3.5(h9)	2.7	3	2.55	● 198974
4	0.7	63	7.5	21	4.5(h9)	3.4	3	3.4	● 198975
5	0.8	70	9	25	6	4.9	3	4.3	● 198976
6	1	80	11	30	6	4.9	3	5.1	● 198977
8	1	90	12.5	35	8	6.2	3	7.1	● 198978
8	1.25	90	12.5	35	8	6.2	3	6.9	● 198979
10	1.25	100	14	39	10	8	3	8.9	● 198980
10	1.5	100	14	39	10	8	3	8.6	● 198981

$\emptyset d_1$ MJ	P mm	l_1 mm	l_2 mm	d_2 mm	a mm			ID
3	0.5	56	12	3.5	2.7	3	2.55	● 199006
4	0.7	63	14	4.5	3.4	3	3.4	● 199007
5	0.8	70	15	6	4.9	3	4.3	● 199008
6	1	80	20	6	4.9	3	5.1	● 199009
8	1	90	25	8	6.2	3	7.1	● 199010
8	1.25	90	25	8	6.2	3	6.9	● 199011
10	1.25	100	30	10	8	3	8.9	● 199012
10	1.5	100	30	10	8	3	8.6	● 199013

$\leq MJ5 \times 0.8 =$ **4H6H**

aero

SA320-4



15 16 52 64

SA350-3



15 16 52 64

TL351VS-3



41 42

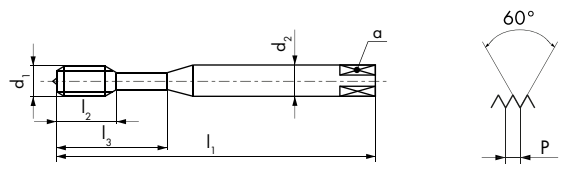



SA320-4

SA350-3

TL351VS-3



$\emptyset d_1$ MJ	P mm	l_1 mm	l_2 mm	l_3 mm	d_2 mm	a mm			ID	ID	ID
3	0.5	56	12		3.5	2.7	3	2.55	● 198990	● 198998	● 198982
4	0.7	63	14		4.5	3.4	3	3.4	● 198991	● 198999	● 198983
5	0.8	70	15		6	4.9	3	4.3	● 198992	● 199000	● 198984
6	1	80	15	23	6	4.9	3	5.1	● 198993	● 199001	● 198985
8	1	90	18	29	8	6.2	3	7.1	● 198994	● 199002	● 198986
8	1.25	90	18	29	8	6.2	3	6.9	● 198995	● 199003	● 198987
10	1.25	100	20	33	10	8	3	8.9	● 198996	● 199004	● 198988
10	1.5	100	20	33	10	8	3	8.6	● 198997	● 199005	● 198989

$\leq MJ5 \times 0.8 =$ **4H6H**

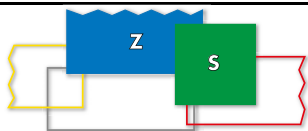
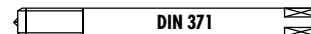
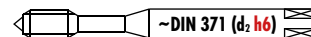

S320VS-4

S370VX-3

SA390-3

S320VS-4



S370VX-3



aero

SA390-3

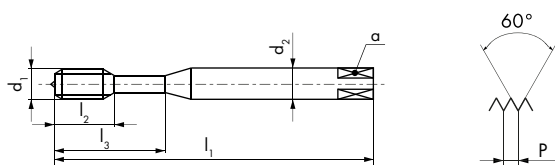

Ø" d ₁ UNJC	P TPI	d ₁ mm	l ₁ mm	l ₂ mm	l ₃ mm	d ₂ mm	a mm		
6	32	3.5	56	13	20	4	3	3	2.8
8	32	4.16	63	14	21	4.5	3.4	3	3.45
10	24	4.82	70	15	25	6	4.9	3	3.9
1/4	20	6.35	80	17	30	7	5.5	3	5.2

ID

- 199014
- 199015
- 199016
- 199017

Ø" d ₁ UNJC	P TPI	d ₁ mm	l ₁ mm	l ₂ mm	l ₃ mm	d ₂ h ₆ mm	a mm		
6	32	3.5	56	6.5	20	4 (h9)	3	3	2.8
8	32	4.16	63	7.5	21	4.5(h9)	3.4	3	3.45
10	24	4.82	70	9	25	6	4.9	3	3.9
1/4	20	6.35	80	11	30	6	4.9	3	5.2

ID

- 199018
- 199019
- 199020
- 199021

Ø" d ₁ UNJC	P TPI	d ₁ mm	l ₁ mm	l ₂ mm	d ₂ mm	a mm		
6	32	3.5	56	13	4	3	3	2.8
8	32	4.16	63	14	4.5	3.4	3	3.45
10	24	4.82	70	15	6	4.9	3	3.9
1/4	20	6.35	80	20	7	5.5	3	5.2

ID

- 199034
- 199035
- 199036
- 199037

aero

SA320-4



15 16 52 64

SA350-3



15 16 52 64

TL351VS-3





41 42

SA320-4

SA350-3

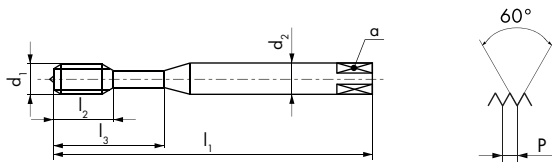
TL351VS-3



Ø" d ₁ UNJC	P TPI	d ₁ mm	l ₁ mm	l ₂ mm	l ₃ mm	d ₂ mm	a mm		
6	32	3.5	56	13		4	3	3	2.8
8	32	4.16	63	14		4.5	3.4	3	3.45
10	24	4.82	70	15		6	4.9	3	3.9
1/4	20	6.35	80	15	23	7	5.5	3	5.2

ID

ID

ID

● 199026	● 199030	● 199022
● 199027	● 199031	● 199023
● 199028	● 199032	● 199024
● 199029	● 199033	● 199025

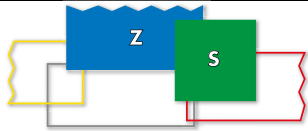
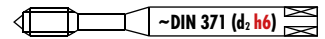
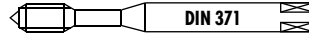

S320VS-4



S370VX-3



aero

SA390-3

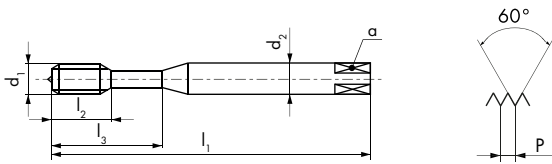

S320VS-4

S370VX-3

SA390-3



Ø" d ₁ UNJF	P TPI	d ₁ mm	l ₁ mm	l ₂ mm	l ₃ mm	d ₂ mm	a mm		
10	32	4.82	70	15	25	6	4.9	3	4.1
1/4	28	6.35	80	17	30	7	5.5	3	5.55
5/16	24	7.93	90	20	35	8	6.2	3	7
3/8	24	9.52	100	22	39	10	8	3	8.6

ID

- 199038
- 199039
- 199040
- 199041

Ø" d ₁ UNJF	P TPI	d ₁ mm	l ₁ mm	l ₂ mm	l ₃ mm	d ₂ h ₆ mm	a mm		
10	32	4.82	70	9	25	6	4.9	3	4.1
1/4	28	6.35	80	11	30	6	4.9	3	5.55
5/16	24	7.93	90	12.5	35	8	6.2	3	7
3/8	24	9.52	100	14	39	10	8	3	8.6

ID

- 197707
- 197708
- 197709
- 197710

Ø" d ₁ UNJF	P TPI	d ₁ mm	l ₁ mm	l ₂ mm	d ₂ mm	a mm		
10	32	4.82	70	15	6	4.9	3	4.1
1/4	28	6.35	80	20	7	5.5	3	5.55
5/16	24	7.93	90	25	8	6.2	3	7
3/8	24	9.52	100	30	10	8	3	8.6

ID

- 199049
- 199050
- 199051
- 199052

aero

SA320-4



15 16 52 64

SA350-3



15 16 52 64

TL351VS-3





41 42

SA320-4

SA350-3

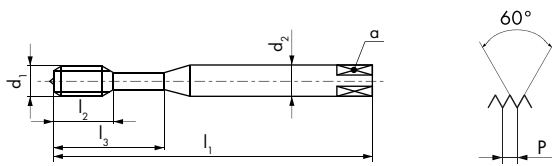























TL351VS-3

































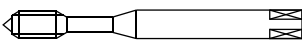
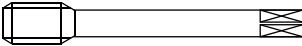

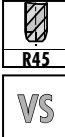
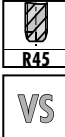

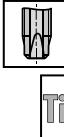
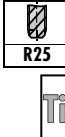

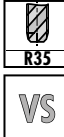



Ø" d ₁ UNJF	P TPI	d ₁ mm	l ₁ mm	l ₂ mm	l ₃ mm	d ₂ mm	a mm		
10	32	4.82	70	15		6	4.9	3	4.1
1/4	28	6.35	80	15	23	7	5.5	3	5.55
5/16	24	7.93	90	18	29	8	6.2	3	7
3/8	24	9.52	100	20	33	10	8	3	8.6









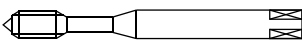
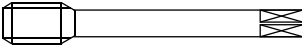





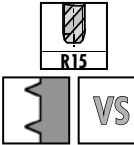











ID	ID	ID
● 174976	● 188175	● 199042
● 175993	● 199046	● 199043
● 175995	● 199047	● 199044
● 175997	● 199048	● 199045





















		N						
Caractéristiques Caratteristiche								
Genre de trou Tipo di foro								
		N310-3	N320-3 N320-4	N320V-3 N320V-4	N320TN-3/-4 N320TC-3/-4	N321-3 N321-4	N330-3 N330-4	N330V-3 N330V-4
DIN longue DIN lungo	DIN 371	60 / 62	62 / 64	60 / 64	64	70	70	70
Extra-longue Extra-lungo	DC							
ISO courte ISO corto	ISO 529							
DIN courte DIN corto	DIN 352							
Tolérance Tolleranza	ISO 2 6H	60 / 62	62 / 64	60 / 64	64	70	70	70
Surcote Maggiorazione	ISO 3 6G		68	68				
Surcote Maggiorazione	7G		68					
Surcote Maggiorazione	+ 0.10 mm + 0.20 mm		68					
Tolérance fine Tolleranza fine	ISO 1 4H		66					
LH Filetage à gauche LH Filettatura sinistra	ISO 2 6H	62	66	66				
		N410-3	N420-4	N420V-4	N420TN-4 N420TC-4	N421-4	N430-4	N430V-4
DIN longue DIN lungo	DIN 376	63	65	65	65	71	71	71
Extra-longue Extra-lungo	DC							
ISO courte ISO corto	ISO 529							
DIN courte DIN corto	DIN 352							
Tolérance Tolleranza	ISO 2 6H	63	65	65	65	71	71	71
Surcote Maggiorazione	ISO 3 6G		69	69				
Surcote Maggiorazione	7G		69					
Surcote Maggiorazione	+ 0.10 mm + 0.20 mm		69 / 71					
Tolérance fine Tolleranza fine	ISO 1 4H		67					
LH Filetage à gauche LH Filettatura sinistra	ISO 2 6H	63	67	67				

N								
 R15 	 R40	 R40 	 R40 TiN TiCN	 R40 	 R40 	 R40  		 
								
N350-3 N350V-3	N360-3	N360V-3	N360TN-3 N360TC-3	N360-5 N360V-5	N361-3	N362V-3	N520-4	N520V-4
72	74	60 / 74	74	80	80	80	82	82
72	74	60 / 74	74	80	80	80	82	82
	76	76						
	78	78						
	78	78						
	78							
	76	76						
N450-3 N450V-3	N460-3	N460V-3	N460TN-3 N460TC-3	N460-5 N460V-5	N461-3	N462V-3	N620-4	N620V-4
73	75	75	75	81	81	81	83	83
73	75	75	75	81	81	81	83	83
	77	77						
	79	79						
	79	79						
	79							
	77	77						

		N								
Caractéristiques Caratteristiche		 TiN	 R40	 R40	 V	 R40	 TiN		 R40	
										
Genre de trou Tipo di foro										
		N520TN-4	N560-3	N560V-3	N560TN-3	N1120-4	N1160-3	N1110 -1 -2 -3 -S		
<i>DIN longue</i> DIN lungo	DIN 371									
<i>Extra-longue</i> Extra-lungo	DC	82	84	84	84					
<i>ISO courte</i> ISO corto	ISO 529					118	118	60 / 114		
<i>DIN courte</i> DIN corto	DIN 352									
<i>Tolérance</i> Tolleranza	ISO 2 6H	82	84	84	84	118	118	60 / 114		
<i>Surcote</i> Maggiorazione	ISO 3 6G									
<i>Surcote</i> Maggiorazione	7G									
<i>Surcote</i> Maggiorazione	+ 0.10 mm + 0.20 mm									
<i>Tolérance fine</i> Tolleranza fine	ISO 1 4H									
<i>LH Filetage à gauche</i> LH Filettatura sinistra	ISO 2 6H									
		N620TN-4	N660-3	N660V-3	N660TN-3	N1220-4	N1260-3	N1210 -1 -2 -3 -S		
<i>DIN longue</i> DIN lungo	DIN 376									
<i>Extra-longue</i> Extra-lungo	DC	83	85	85	85					
<i>ISO courte</i> ISO corto	ISO 529					118	118	60 / 115		
<i>DIN courte</i> DIN corto	DIN 352									
<i>Tolérance</i> Tolleranza	ISO 2 6H	83	85	85	85	118	118	60 / 115		
<i>Surcote</i> Maggiorazione	ISO 3 6G									
<i>Surcote</i> Maggiorazione	7G									
<i>Surcote</i> Maggiorazione	+ 0.10 mm + 0.20 mm									
<i>Tolérance fine</i> Tolleranza fine	ISO 1 4H									
<i>LH Filetage à gauche</i> LH Filettatura sinistra	ISO 2 6H									





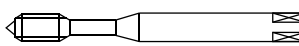
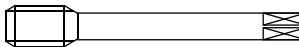



















	Z		ZX	H		S	
Caractéristiques Caratteristiche							
							
Genre de trou Tipo di foro							
	Z370VS-3	Z373VS-3	ZX320-4	H320-4 H320TC-4	H350-3 H350TC-3	S320VS-4	S360VS-3
DIN longue DIN lungo	DIN 371		93	94	96	98	99
Extra-longue Extra-lungo	DC						
ISO courte ISO corto	ISO 529						
DIN courte DIN corto	DIN 352						
Tolérance Tolleranza	ISO 2 6H	90	90	93	94	96	98
Surcote Maggiorazione	ISO 3 6G				96		
Surcote Maggiorazione	7G						
Surcote Maggiorazione	+ 0.10 mm + 0.20 mm						
Tolérance fine Tolleranza fine	ISO 1 4H	90				98	
LH Filetage à gauche LH Filettatura sinistra	ISO 2 6H						
	Z470VS-3	Z473VS-3	ZX420-4	H420-4 H420TC-4	H450-3 H450TC-3	S420VS-4	S460VS-3
DIN longue DIN lungo	DIN 376		93	95	97	98	99
Extra-longue Extra-lungo	DC						
ISO courte ISO corto	ISO 529						
DIN courte DIN corto	DIN 352						
Tolérance Tolleranza	ISO 2 6H	91	91	93	95	97	98
Surcote Maggiorazione	ISO 3 6G				97		
Surcote Maggiorazione	7G						
Surcote Maggiorazione	+ 0.10 mm + 0.20 mm						
Tolérance fine Tolleranza fine	ISO 1 4H						
LH Filetage à gauche LH Filettatura sinistra	ISO 2 6H						

SA			TL		GG			
								
								
								
SA320-4	SA350-3	SA390-3	TL320VS-4	TL351VS-3	GG350NV-3	GG350TC-3	GG353TC-3	GG550NV-3
100	100	99	100	100	102	102	102	102
								102
100	100	99	100	100	102	102	102	102
100	100	99	100	100				
SA420-4	SA450-3		TL420VS-4	TL451VS-3	GG450NV-3	GG450TC-3	GG453TC-3	GG650NV-3
101	101		101	101	103	103	103	103
								103
101	101		101	101	103	103	103	103
101	101		101	101				

	K			QTAP			
Caractéristiques Caratteristiche	 TiCN	 TiCN	 VS	 VS	 VS	 R40 VS	 R40 VS
				 NEW	 NEW	 NEW	 NEW
Genre de trou Tipo di foro							
	K313TC-3			Q320VS-4	Q323VS-4	Q360VS-3	Q363VS-3
<i>DIN longue</i> DIN lungo	DIN 371			61 / 106	106	61 / 107	107
<i>Extra-longue</i> Extra-lungo	DC						
<i>ISO courte</i> ISO corto	ISO 529						
<i>DIN courte</i> DIN corto	DIN 352						
<i>Tolérance</i> Tolleranza	ISO 2 6H	104		61 / 106	106	61 / 107	107
<i>Surcote</i> Maggiorazione	ISO 3 6G						
<i>Surcote</i> Maggiorazione	7G						
<i>Surcote</i> Maggiorazione	+ 0.10 mm + 0.20 mm						
<i>Tolérance fine</i> Tolleranza fine	ISO 1 4H						
<i>LH Filetage à gauche</i> LH Filettatura sinistra	ISO 2 6H						
	K413TC-3	K613TC-3	K613VS-3	Q420VS-4	Q423VS-4	Q460VS-3	Q463VS-3
<i>DIN longue</i> DIN lungo	DIN 376	104		106	106	107	107
<i>Extra-longue</i> Extra-lungo	DC	105	105				
<i>ISO courte</i> ISO corto	ISO 529						
<i>DIN courte</i> DIN corto	DIN 352						
<i>Tolérance</i> Tolleranza	ISO 2 6H	104	105	105	106	106	107
<i>Surcote</i> Maggiorazione	ISO 3 6G						
<i>Surcote</i> Maggiorazione	7G						
<i>Surcote</i> Maggiorazione	+ 0.10 mm + 0.20 mm						
<i>Tolérance fine</i> Tolleranza fine	ISO 1 4H						
<i>LH Filetage à gauche</i> LH Filettatura sinistra	ISO 2 6H						















Répertoire — Tarauds à machine ISO DIN 13
Rubrica — Maschi a macchina ISO DIN 13

RTS							
 VS	 VS	 R40 VS	 R40 VS	 R40 E 1.5xP VS	 R40 E 1.5xP VS	 VS	 R40 VS
							
							
RTS320VS-4	RTS323VS-4	RTS360VS-3 RTS362VS-3	RTS365VS-3	RTS362VS-5	RTS365VS-5	RTS523VS-4	RTS565VS-3
108	108	109	109	111	111	112	112
108	108	109	109	111	111	112	112
		110					
		110					
RTS420VS-4	RTS423VS-4	RTS462VS-3	RTS465VS-3			RTS623VS-4	RTS665VS-3
108	108	109	109			112	112
108	108	109	109			112	112
		110					
		110					

Assortiments de tarauds







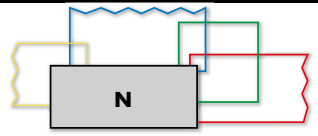

Assortimenti di maschi

BOXSET	D5855	D5860	D5891
<p>D5855  ISO 2 6H N1110-S M3, M4, M5, M6, M8, M10, N1210-S M12</p> <p>D5860  ISO 2 6H N1110-S M3, M4, M5, M6, M8, M10, N1210-S M12  HSS FO DIN 338 D2.5, 3.3, 4.2, 5.0, FO DIN 338 6.8, 8.5, 10.2</p> <p>D5891  ISO 2 6H N310-3 M3, M4, M5, M6, M8, M10, N410-3 M12</p>			
No D5855 / D5860 / D5891	ID	ID	ID
M3 - M12	● 118728	● 118733	● 170922
BOXSET	D5892		
<p>D5892   ISO 2 6H N320V-4 M3, M4, M5, M6, M8, M10</p> <p></p>			
No D5892	ID		
M3 - M10	● 170921		
BOXSET	D5896		
<p>D5896  R40  ISO 2 6H N360V-3 M3, M4, M5, M6, M8, M10</p> <p></p>			
No D5896	ID		
M3 - M10	● 167599		

Assortiments de tarauds — QTAP
Assortimenti di maschi — QTAP

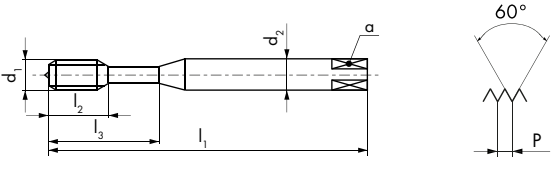
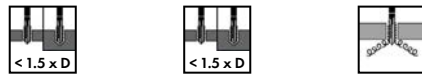
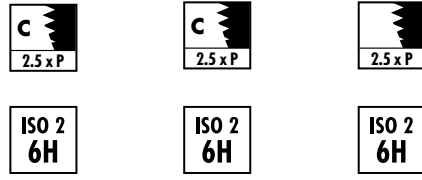
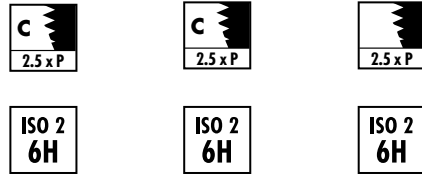

BOXSET	D5893
<p>Q320VS-4</p> <p>M3, M4, M5 M6, M8, M10</p> <p>VS</p>	<p>NEW</p>
<p>No D5893</p>	<p>ID</p>
<p>M3 - M10</p>	<p>● 197104</p>
BOXSET	D5897
<p>Q360VS-3</p> <p>M3, M4, M5 M6, M8, M10</p> <p>VS</p>	<p>NEW</p>
<p>No D5897</p>	<p>ID</p>
<p>M3 - M10</p>	<p>● 197105</p>

										N310-3	N310-3 LH	N320-3
										<p>N310-3  31 62 73 74 91</p> <p>N310-3 LH  LH 31 62 73 74 91</p> <p>N320-3  62 63 64 72 73 74 81 91</p>		
												
												
Ø d ₁ M	P mm	l ₁ mm	l ₂ mm	l ₃ mm	d ₂ mm	a mm			ID	ID	ID	
1	0.25	40	5.5		2.5	2.1	3	0.75	● 150167			
1.1	0.25	40	5.5		2.5	2.1	3	0.85	● 174745			
1.2	0.25	40	5.5		2.5	2.1	3	0.95	● 150168			
1.4	0.3	40	7		2.5	2.1	3	1.1	● 150169			
1.5	0.3	40	7		2.5	2.1	3	1.2	● 174752			
1.6	0.35	40	8		2.5	2.1	3	1.25	● 174753			
1.7	0.35	40	8		2.5	2.1	3	1.35	● 174754			
1.8	0.35	40	8		2.5	2.1	3	1.45	● 174755			
2	0.4	45	8		2.8	2.1	3	1.6	● 101439	● 111460		
2.2	0.45	45	9		2.8	2.1	3	1.75	● 174756			
2.3	0.4	45	9		2.8	2.1	3	1.9	● 174757			
2.5	0.45	50	10		2.8	2.1	3	2.05	● 101440	● 111461		
2.6	0.45	50	10		2.8	2.1	3	2.15	● 101441			
3	0.5	56	12	18	3.5	2.7	3	2.5	● 101442	● 111462		
3.5	0.6	56	13	20	4	3	3	2.9	● 101443			
4	0.7	63	14	21	4.5	3.4	3	3.3	● 101444	● 111464		
5	0.8	70	15	25	6	4.9	* 3	4.2	● 101445	● 111465	* 101465	
6	1	80	17	30	6	4.9	* 3	5	● 101446	● 111466	* 101466	
8	1.25	90	20	35	8	6.2	3	6.8	● 101447			
10	1.5	100	22	39	10	8	3	8.5	● 101438			
<p>*N320-3 =  2</p>												

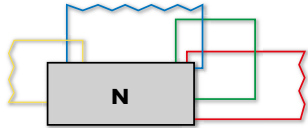

N410-3



31 / 62 / 73 / 74 / 91

N410-3 LH





31 / 62 / 73 / 74 / 91



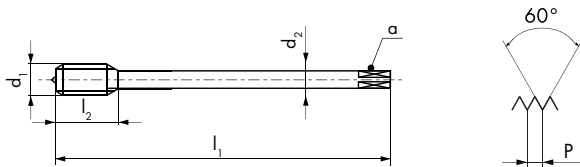







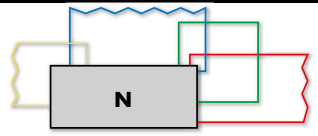



















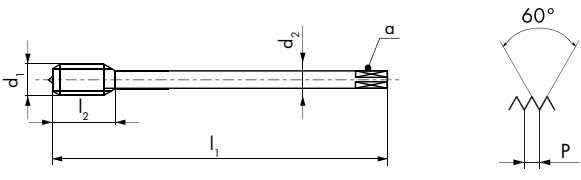

N410-3

N410-3 LH









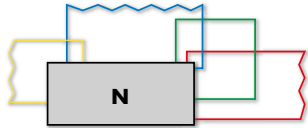

$\emptyset d_1$ M	P mm	l_1 mm	l_2 mm	d_2 mm	a mm			ID	ID
3	0.5	56	12	2.2	1.8	3	2.5	● 101897	
4	0.7	63	14	2.8	2.1	3	3.3	● 101924	
5	0.8	70	15	3.5	2.7	3	4.2	● 101942	
6	1	80	17	4.5	3.4	3	5	● 101953	
7	1	80	17	5.5	4.3	3	6	● 142645	● 111491
8	1.25	90	20	6	4.9	3	6.8	● 101958	● 111492
10	1.5	100	22	7	5.5	3	8.5	● 101866	● 111478
12	1.75	110	24	9	7	3	10.2	● 101870	● 111479
14	2	110	28	11	9	3	12	● 101874	● 111480
16	2	110	30	12	9	3	14	● 101880	● 111481
18	2.5	125	33	14	11	3	15.5	● 101883	● 111482
20	2.5	140	36	16	12	3	17.5	● 101885	● 125530
22	2.5	140	36	18	14.5	3	19.5	★ 101888	
24	3	160	39	18	14.5	4	21	● 101891	● 111485
27	3	160	42	20	16	4	24	● 101895	● 111486
30	3.5	180	45	22	18	4	26.5	● 101901	● 111487
33	3.5	180	48	25	20	4	29.5	★ 101907	
36	4	200	51	28	22	4	32	● 101915	● 111488
39	4	200	55	32	24	4	35	● 101922	
42	4.5	200	55	32	24	4	37.5	● 101932	
48	5	250	63	36	29	4	43	● 111489	
56	5.5	280	71	45	35	5	50.5	● 111447	

										N320-4	N320V-4	N320TN-4	N320TC-4
N320-4			62 63 64 72 73 74 81 91										
N320V-4		V	11 12 31 32										
N320TN-4		TiN	11 12 13 14 32										
N320TC-4		TiCN	11 12 13 14 21 31 32 62 64 73 74 82 83										
Ø d ₁ M	P mm	l ₁ mm	l ₂ mm	l ₃ mm	d ₂ mm	a mm				ID	ID	ID	ID
* 1	0.25	40	5.5		2.5	2.1	2	0.75		● 111467			
* 1.1	0.25	40	5.5		2.5	2.1	2	0.85		● 111468			
* 1.2	0.25	40	5.5		2.5	2.1	2	0.95		● 111469			
* 1.4	0.3	40	7		2.5	2.1	2	1.1		● 111470			
* 1.5	0.3	40	7		2.5	2.1	2	1.2		● 111471			
* 1.6	0.35	40	8		2.5	2.1	2	1.25		● 101454			
* 1.7	0.35	40	8		2.5	2.1	2	1.35		● 101455			
* 1.8	0.35	40	8		2.5	2.1	2	1.45		● 101456			
* 2	0.4	45	8		2.8	2.1	2	1.6		● 101458	● 101536	● 101528	● 152900
* 2.2	0.45	45	9		2.8	2.1	2	1.75		● 101459			
* 2.3	0.4	45	9		2.8	2.1	2	1.9		● 101460			
2.5	0.45	50	10		2.8	2.1	3	2.05		● 101483	● 101545	● 101530	● 101522
2.6	0.45	50	10		2.8	2.1	3	2.15		● 101484			
3	0.5	56	12	18	3.5	2.7	3	2.5		● 101485	● 101546	● 101531	● 101523
3.5	0.6	56	13	20	4	3	3	2.9		● 101491	● 101547		
4	0.7	63	14	21	4.5	3.4	3	3.3		● 101495	● 101548	● 101532	● 101524
5	0.8	70	15	25	6	4.9	3	4.2		● 101499	● 101549	● 101533	● 101525
6	1	80	17	30	6	4.9	3	5		● 101503	● 101550	● 101534	● 101526
8	1.25	90	20	35	8	6.2	3	6.8		● 101506	● 101551	● 101535	● 101527
10	1.5	100	22	39	10	8	3	8.5		● 101481	● 101544	● 101529	● 101521
*N320-3 / N320V-3 N320TN-3 / N320TC-3													



									N420-4	N420V-4	N420TN-4	N420TC-4				
N420-4					<div style="display: flex; flex-wrap: wrap; gap: 5px;"> <div style="border: 1px solid black; padding: 2px;">62</div> <div style="border: 1px solid black; padding: 2px;">63</div> <div style="border: 1px solid black; padding: 2px;">64</div> <div style="border: 1px solid black; padding: 2px;">72</div> <div style="border: 1px solid black; padding: 2px;">73</div> <div style="border: 1px solid black; padding: 2px;">74</div> <div style="border: 1px solid black; padding: 2px;">81</div> <div style="border: 1px solid black; padding: 2px;">91</div> </div>					   						
N420V-4					<div style="display: flex; flex-wrap: wrap; gap: 5px;"> <div style="border: 1px solid black; padding: 2px;">11</div> <div style="border: 1px solid black; padding: 2px;">12</div> <div style="border: 1px solid black; padding: 2px;">31</div> <div style="border: 1px solid black; padding: 2px;">32</div> </div>											
N420TN-4					<div style="display: flex; flex-wrap: wrap; gap: 5px;"> <div style="border: 1px solid black; padding: 2px;">11</div> <div style="border: 1px solid black; padding: 2px;">12</div> <div style="border: 1px solid black; padding: 2px;">13</div> <div style="border: 1px solid black; padding: 2px;">14</div> <div style="border: 1px solid black; padding: 2px;">32</div> </div>											
N420TC-4					<div style="display: flex; flex-wrap: wrap; gap: 5px;"> <div style="border: 1px solid black; padding: 2px;">11</div> <div style="border: 1px solid black; padding: 2px;">12</div> <div style="border: 1px solid black; padding: 2px;">13</div> <div style="border: 1px solid black; padding: 2px;">14</div> <div style="border: 1px solid black; padding: 2px;">21</div> <div style="border: 1px solid black; padding: 2px;">31</div> <div style="border: 1px solid black; padding: 2px;">32</div> <div style="border: 1px solid black; padding: 2px;">62</div> <div style="border: 1px solid black; padding: 2px;">64</div> <div style="border: 1px solid black; padding: 2px;">73</div> <div style="border: 1px solid black; padding: 2px;">74</div> <div style="border: 1px solid black; padding: 2px;">82</div> <div style="border: 1px solid black; padding: 2px;">83</div> </div>											
									 4 x P	 4 x P	 4 x P	 4 x P	 ISO 2 6H	 ISO 2 6H	 ISO 2 6H	 ISO 2 6H
$\emptyset d_1$ M	P mm	l_1 mm	l_2 mm	d_2 mm	a mm				ID	ID	ID	ID				
3	0.5	56	12	2.2	1.8	3	2.5		● 102119	● 143418						
4	0.7	63	14	2.8	2.1	3	3.3		● 102146	● 102279						
5	0.8	70	15	3.5	2.7	3	4.2		● 102171	● 102280	● 146297					
6	1	80	17	4.5	3.4	3	5		● 102182	● 102282	● 147439					
7	1	80	17	5.5	4.3	3	6		● 102189	● 144713						
8	1.25	90	20	6	4.9	3	6.8		● 102195	● 102285	● 102251	● 102233				
9	1.25	90	20	7	5.5	3	7.8		● 102202							
10	1.5	100	22	7	5.5	3	8.5		● 102061	● 102263	● 102240	● 102228				
11	1.5	100	19	8	6.2	3	9.5		● 162770							
12	1.75	110	24	9	7	3	10.2		● 102072	● 102265	● 102243	● 102229				
14	2	110	28	11	9	3	12		● 102081	● 102267	● 102245					
16	2	110	30	12	9	3	14		● 102090	● 102269	● 102247	● 102231				
18	2.5	125	33	14	11	3	15.5		● 102097	● 102271						
20	2.5	140	36	16	12	3	17.5		● 102101	● 102273	● 102248	● 102232				
22	2.5	140	36	18	14.5	3	19.5		● 102106	● 102275						
24	3	160	39	18	14.5	4	21		● 102110	● 102278	● 144220	● 163736				
27	3	160	42	20	16	4	24		● 102117	● 143856						
30	3.5	180	45	22	18	4	26.5		● 102124	● 105124						
33	3.5	180	48	25	20	4	29.5		● 102130	● 146968						
36	4	200	51	28	22	4	32		● 102137	● 143430						
39	4	200	55	32	24	4	35		● 102144	● 158724						
42	4.5	200	55	32	24	4	37.5		● 102158	● 143107						
45	4.5	220	59	36	29	4	40.5		● 110225	● 159565						
48	5	250	63	36	29	4	43		● 110226	● 157517						
56	5.5	280	71	45	35	5	50.5		● 110229	● 158178						



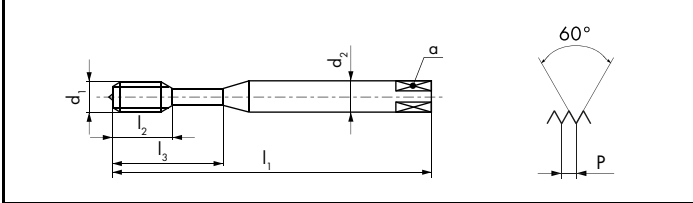

N320-4			62 63 64 72 73 74 81 91
N320-4 LH		LH	62 63 64 72 73 74 81 91
N320V-4 LH		V LH	11 12 31 32

N320-4	N320-4 LH	N320V-4 LH
		
		



		
ISO 1 4H	ISO 2 6H	ISO 2 6H

Ø d ₁ M	P mm	l ₁ mm	l ₂ mm	l ₃ mm	d ₂ mm	a mm			ID	ID	ID
* 2	0.4	45	8		2.8	2.1	2	1.6	● 162503	● 111472	● 162771
2.5	0.45	50	10		2.8	2.1	3	2.05	● 159345		
3	0.5	56	12	18	3.5	2.7	3	2.5	● 101487	● 111473	● 162772
4	0.7	63	14	21	4.5	3.4	3	3.3	● 101493	● 111474	● 162773
5	0.8	70	15	25	6	4.9	3	4.2	● 101497	● 111475	● 162774
6	1	80	17	30	6	4.9	3	5	● 101501	● 111476	● 162775
10	1.5	100	22	39	10	8	3	8.5	★ 146484		

*N320-3 / N320V-3



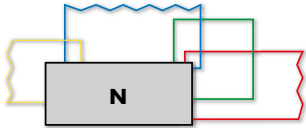

N420-4			62 63 64 72 73 74 81 91
N420-4 LH		LH	62 63 64 72 73 74 81 91
N420V-4 LH		V LH	11 12 31 32

N420-4	N420-4 LH	N420V-4 LH	

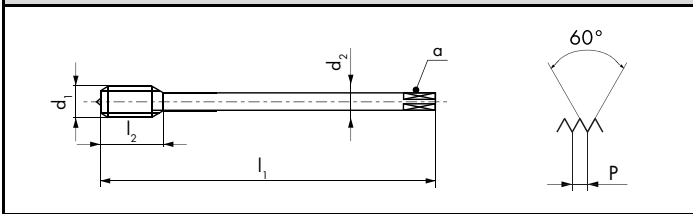

ISO 1 4H	ISO 2 6H	ISO 2 6H

$\emptyset d_1$ M	P mm	l_1 mm	l_2 mm	d_2 mm	a mm			ID	ID	ID
8	1.25	90	20	6	4.9	3	Δ 6.8	● 102193	● 102198	● 142621
10	1.5	100	22	7	5.5	3	8.5	● 102059	● 102064	● 143287
12	1.75	110	24	9	7	3	10.2	● 102070	● 102040	● 146583
14	2	110	28	11	9	3	12		● 102084	● 146563
16	2	110	30	12	9	3	14		● 102093	● 143108
20	2.5	140	36	16	12	3	17.5		● 102103	● 145579
24	3	160	39	18	14.5	4	21		● 111493	● 145578

Δ ISO 1 4H = 6.70

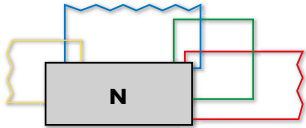

N320-4



62 63 64 72 73 74
81 91

N320V-4



11 12 31 32



N320-4

N320V-4

N320-4

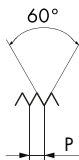
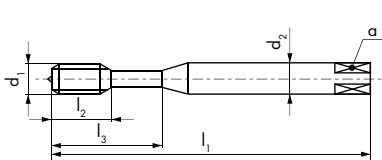
N320-4



Ø d ₁ M	P mm	l ₁ mm	l ₂ mm	l ₃ mm	d ₂ mm	a mm		
* 2	0.4	45	8		2.8	2.1	2	1.6
2.5	0.45	50	10		2.8	2.1	3	2.05
3	0.5	56	12	18	3.5	2.7	3	2.5
3.5	0.6	56	13	20	4	3	3	2.95
4	0.7	63	14	21	4.5	3.4	3	3.35
5	0.8	70	15	25	6	4.9	3	4.25
6	1	80	17	30	6	4.9	3	5
8	1.25	90	20	35	8	6.2	3	6.8





ID	6H + mm	ID	6H + mm	ID	6H + mm	ID
● 101457	0.019	● 143584	0.019			
● 101482	0.020	● 150522	0.020			
● 101486	0.020	● 143116	0.020	● 101489	0.036	● 101488
● 101490	0.021					
● 101494	0.022	● 143087	0.022	● 101496	0.041	● 111522
● 101498	0.024	● 143088	0.024	● 101500	0.044	● 111523
● 101502	0.026	● 143089	0.026	● 101504	0.050	● 111524
● 101505	0.028	● 143604	0.028			

*N320-3 / N320V-3

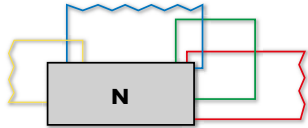





								N420-4	N420V-4	N420-4	N420-4
N420-4		62	63	64	72	73	74				
		81	91								
N420V-4		V	11	12	31	32					
								ISO 3 6G	ISO 3 6G	7G	6H +0.1 mm
$\emptyset d_1$ M	P mm	l_1 mm	l_2 mm	d_2 mm	a mm			ID 6H + mm	ID 6H + mm	ID 6H + mm	ID
8	1.25	90	20	6	4.9	3	6.8	● 102194 0.028	● 145246 0.028	● 102199 0.052	● 102196
10	1.5	100	22	7	5.5	3	8.5	● 102060 0.032	● 143726 0.032	● 102065 0.060	● 102062
12	1.75	110	24	9	7	3	10.3	● 102071 0.034	● 145655 0.034	● 102076 0.066	● 102073
16	2	110	30	12	9	3	14	● 135531 0.038	● 162795 0.038	● 102094 0.072	● 102091







N321-4			61 62 63 64 71 72 73 74 81 91
N330-4			63 72
N330V-4			11 12

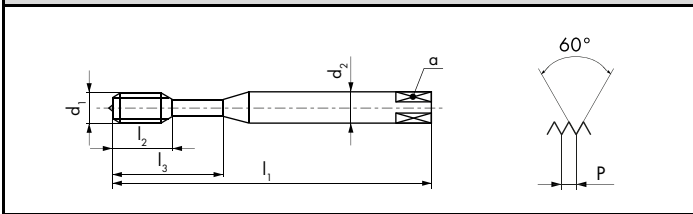

N321-4	N330-4	N330V-4	
--------	--------	---------	--



		
	< 1.5 x D	< 1.5 x D
		
	=X =Y	=X =Y





		
ISO 2 6H	ISO 2 6H	ISO 2 6H

Ø d ₁ M	P mm	l ₁ mm	l ₂ mm	l ₃ mm	d ₂ mm	a mm		
* 1	0.25	40	5.5		2.5	2.1	2	0.75
* 1.1	0.25	40	5.5		2.5	2.1	2	0.85
* 1.2	0.25	40	5.5		2.5	2.1	2	0.95
* 1.4	0.3	40	7		2.5	2.1	2	1.1
* 1.6	0.35	40	8		2.5	2.1	2	1.25
* 2	0.4	45	8		2.8	2.1	2	1.6
2.5	0.45	50	10		2.8	2.1	* 3	2.05
3	0.5	56	12	18	3.5	2.7	* 3	2.5
3.5	0.6	56	13	20	4	3	2	2.9
4	0.7	63	14	21	4.5	3.4	3	3.3
5	0.8	70	15	25	6	4.9	3	4.2
6	1	80	17	30	6	4.9	3	5

ID	ID	ID
	● 101558	
	* 101559	
	● 101560	
	● 101561	
	● 101562	● 151246
● 101552	● 105125	● 101572
● 101553	● 101565	● 101573
● 101555	● 101567	● 101574
	● 101568	
● 101557	● 101569	● 101576
	● 101570	● 101577
	● 101571	● 101578

*N320-3 / N320V-3 / N330V-3 

* N330-4 =  2
* N330V-4 =  2

≤ M1.5 

								N420-4	N421-4	N430-4	N430V-4
N420-4											
N421-4											
N430-4											
N430V-4											
$\emptyset d_1$ M	P mm	l_1 mm	l_2 mm	d_2 mm	a mm			ID	ID	ID	ID
4	0.7	63	14	2.8	2.1	3	3.3		● 102293		
5	0.8	70	15	3.5	2.7	3	4.2		● 102294		
6	1	80	17	4.5	3.4	3	5		● 102295		
8	1.25	90	20	6	4.9	3	6.8	● 102197	● 102296	● 102301	● 102306
10	1.5	100	22	7	5.5	3	8.5	● 102063	● 102286	● 102297	● 102302
12	1.75	110	24	9	7	3	10.2	● 102074	● 102287	● 102298	● 102303
16	2	110	30	12	9	3	14	● 102092	● 102289		

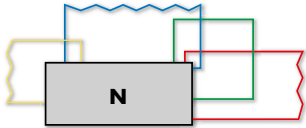

N350-3



62 63 64 72 73 74
81 91

N350V-3



11 12 31 32

N350-3

N350V-3

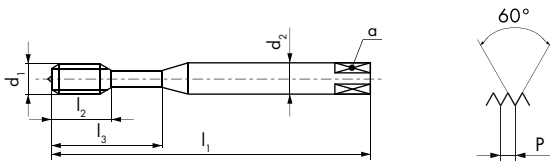

Ø d ₁ M	P mm	l ₁ mm	l ₂ mm	l ₃ mm	d ₂ mm	a mm		
2	0.4	45	8		2.8	2.1	2	1.6
2.3	0.4	45	9		2.8	2.1	2	1.9
2.5	0.45	50	10		2.8	2.1	2	2.05
2.6	0.45	50	10		2.8	2.1	2	2.15
3	0.5	56	12	18	3.5	2.7	2	2.5
3.5	0.6	56	13	20	4	3	2	2.9
4	0.7	63	14	21	4.5	3.4	2	3.3
5	0.8	70	15	25	6	4.9	3	4.2
6	1	80	17	30	6	4.9	3	5
8	1.25	90	20	35	8	6.2	3	6.8
10	1.5	100	22	39	10	8	3	8.5

ID

ID

● 101580	● 101593
● 101581	
● 101582	● 101594
● 101583	
● 101584	● 101595
● 101585	
● 101587	● 101596
● 101589	● 101597
● 101591	● 101598
● 101592	● 146810
● 101579	● 147217

									N450-3	N450V-3		
<p>N450-3</p> <p>62 63 64 72 73 74 81 91</p> <p>N450V-3</p> <p>11 12 31 32</p>												
									<p>< 1.5 x D</p>	<p>< 1.5 x D</p>		
									<p>< 2.5 x D</p>			
									<p>2.5 x P</p>	<p>2.5 x P</p>		
$\emptyset d_1$ M	P mm	l_1 mm	l_2 mm	d_2 mm	a mm				ID	ID		
8	1.25	90	20	6	4.9	3	6.8		● 102327	● 102334		
10	1.5	100	22	7	5.5	3	8.5		● 102314	● 102329		
12	1.75	110	24	9	7	3	10.2		● 102317	● 102330		
14	2	110	28	11	9	3	12		● 102319	● 145487		
16	2	110	30	12	9	3	14		● 102321	● 102331		
20	2.5	140	36	16	12	4	17.5		● 102324	● 102332		
24	3	160	39	18	14.5	4	21		● 102325	● 102333		

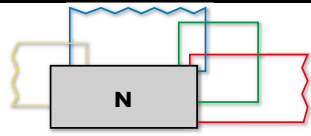

N360-3	N360V-3	N360TN-3	N360TC-3
--------	---------	----------	----------

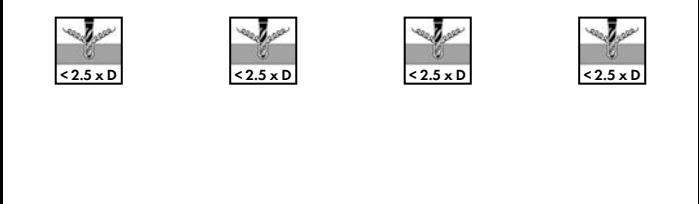



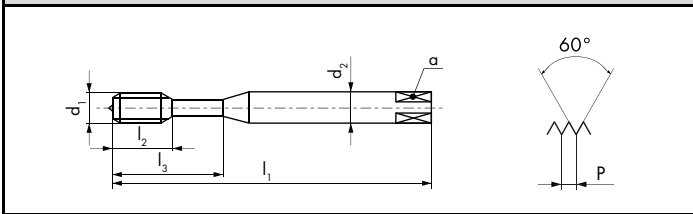

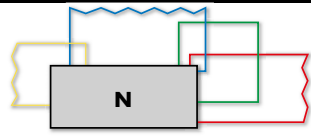

N360-3			63 72 73 74 81 91
N360V-3			11 12 32
N360TN-3			11 12 13 14 32
N360TC-3			11 12 13 14 21 31 32 62 64 73 74 82 83







Ø d ₁ M	P mm	l ₁ mm	l ₂ mm	l ₃ mm	d ₂ mm	a mm			ID	ID	ID	ID
2	0.4	45	7		2.8	2.1	2	1.6	● 101618	● 101708	● 101697	● 146842
2.2	0.45	45	8		2.8	2.1	2	1.75	● 101619			
2.3	0.4	45	8		2.8	2.1	2	1.9	● 101620			
2.5	0.45	50	9		2.8	2.1	2	2.05	● 101622	● 101709	● 101698	● 101689
2.6	0.45	50	9		2.8	2.1	2	2.15	● 101623	● 101710		
3	0.5	56	5.5	18	3.5	2.7	3	2.5	● 101626	● 101711	● 101699	● 101690
3.5	0.6	56	6.5	20	4	3	3	2.9	● 101630	● 142625		
4	0.7	63	7.5	21	4.5	3.4	3	3.3	● 101635	● 101713	● 101700	● 101691
4.5	0.75	70	9	25	6	4.9	3	3.75	● 101639			
5	0.8	70	9	25	6	4.9	3	4.2	● 101644	● 101715	● 101701	● 101692
6	1	80	11	30	6	4.9	3	5	● 101652	● 101717	● 101703	● 101693
7	1	80	11	30	7	5.5	3	6	● 101656	● 101718		
8	1.25	90	12.5	35	8	6.2	3	6.8	● 101663	● 101721	● 101705	● 101694
9	1.25	90	12.5	35	9	7	3	7.8	● 101668			
10	1.5	100	14	39	10	8	3	8.5	● 101612	● 101707	● 101696	● 101688









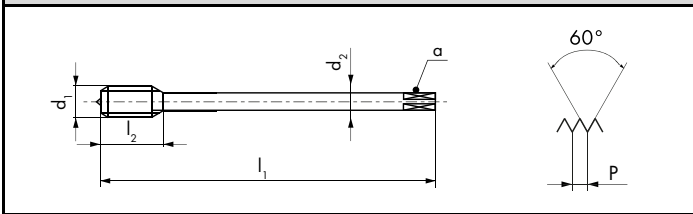

N460-3		63 72 73 74 81 91
N460V-3	 	11 12 32
N460TN-3	 	11 12 13 14 32
N460TC-3	 	11 12 13 14 21 31 32 62 64 73 74 82 83



N460-3	N460V-3	N460TN-3	N460TC-3
--------	---------	----------	----------







			
---	---	---	---



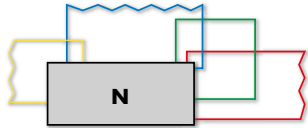



			
			

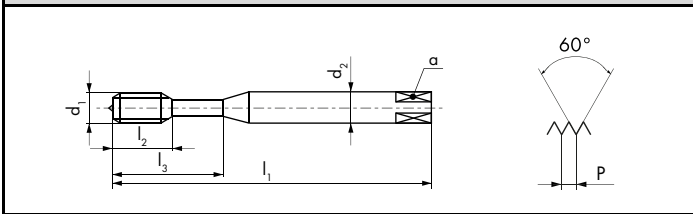
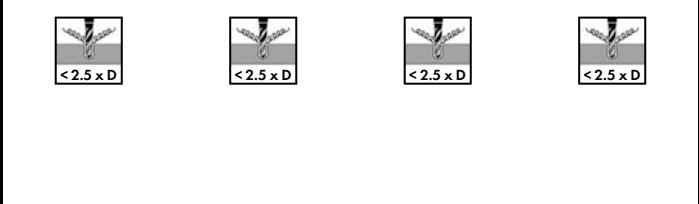

$\emptyset d_1$ M	P mm	l_1 mm	l_2 mm	d_2 mm	a mm			ID	ID	ID	ID
5	0.8	70	9	3.5	2.7	3	4.2	● 102410	● 102489	● 160682	
6	1	80	11	4.5	3.4	3	5	● 102411	● 102491	● 152850	
8	1.25	90	12.5	6	4.9	3	6.8	● 102412	● 102492	● 152849	
10	1.5	100	14	7	5.5	3	8.5	● 102351	● 102461	● 150242	● 158687
12	1.75	110	14	9	7	3	10.2	● 102359	● 102465	● 102449	● 102438
14	2	110	14	11	9	3	12	● 102369	● 102468	● 102451	● 111615
16	2	110	18	12	9	3	14	● 102376	● 102471	● 102453	● 102440
18	2.5	125	21	14	11	3	15.5	● 102383	● 102473		
20	2.5	140	24	16	12	4	17.5	● 102389	● 102475	● 102454	● 143280
22	2.5	140	24	18	14.5	4	19.5	● 102394	● 102477		
24	3	160	27	18	14.5	4	21	● 102398	● 102480	● 143119	● 150018
27	3	160	27	20	16	4	24	● 175423	● 102481		
30	3.5	180	30	22	18	4	26.5	● 150246	● 102482		
33	3.5	180	33	25	20	4	29.5	● 167621	● 102483		
36	4	200	36	28	22	5	32	● 143914	● 102484		
39	4	200	40	32	24	5	35	● 175424	● 102485		
42	4.5	200	40	32	24	5	37.5	● 169122	● 102486		
45	4.5	220	44	36	29	5	40.5		● 102487		
48	5	250	48	36	29	5	43		● 102488		
52	5	250	52	40	32	5	47		● 110228		
56	5.5	280	56	45	35	6	50.5		● 102490		
64	6	315	64	50	39	6	58		● 143805		



N360-3 LH		LH	63 72 73 74 81 91
N360V-3 LH		V	LH 11 12 32
N360-3			63 72 73 74 81 91
N360V-3		V	11 12 32



			
ISO 2 6H	ISO 2 6H	ISO 3 6G	ISO 3 6G

Ø d ₁ M	P mm	l ₁ mm	l ₂ mm	l ₃ mm	d ₂ mm	a mm			ID	ID	ID ^{6H} + mm	ID ^{6H} + mm
2	0.4	45	7		2.8	2.1	2	1.6			● 101617 0.019	● 146000 0.019
2.5	0.45	50	9		2.8	2.1	2	2.05			● 101621 0.020	● 143294 0.020
3	0.5	56	5.5	18	3.5	2.7	3	2.5	● 101627	● 146811	● 101625 0.020	● 104816 0.020
3.5	0.6	56	6.5	20	4	3	3	2.95			● 101629 0.021	● 125829 0.021
4	0.7	63	7.5	21	4.5	3.4	3	3.3	● 101637	● 162540	● 101634 0.022	● 104817 0.022
5	0.8	70	9	25	6	4.9	3	4.2	● 101646	● 144003	● 101643 0.024	● 104818 0.024
6	1	80	11	30	6	4.9	3	5	● 101654	● 144004	● 101669 0.026	● 104819 0.026
8	1.25	90	12.5	35	8	6.2	3	6.8	● 101666	● 143925	● 101662 0.028	● 104820 0.028
10	1.5	100	14	39	10	8	3	8.5	● 101615	● 143587	● 101611 0.032	● 104821 0.032

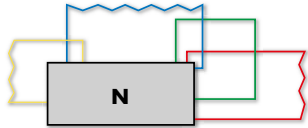

								N460-3 LH	N460V-3 LH	N460-3	N460V-3
<p>N460-3 LH 63 72 73 74 81 91</p> <p>N460V-3 LH 11 12 32</p> <p>N460-3 63 72 73 74 81 91</p> <p>N460V-3 11 12 32</p>											
$\emptyset d_1$ M	P mm	l_1 mm	l_2 mm	d_2 mm	a mm			ID	ID	ID 6H + mm	ID 6H + mm
12	1.75	110	14	9	7	3	10.2	● 102362	● 146354	● 102358 0.034	● 143602 0.034
14	2	110	14	11	9	3	12			● 102368 0.038	● 144712 0.038
16	2	110	18	12	9	3	14	● 102378	● 143439	● 102375 0.038	● 150197 0.038
20	2.5	140	24	16	12	4	17.5	● 102390	● 146564	● 102388 0.042	● 145420 0.042

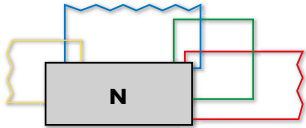

N360-3 **63 72 73 74 81 91**

N360V-3 **11 12 32**

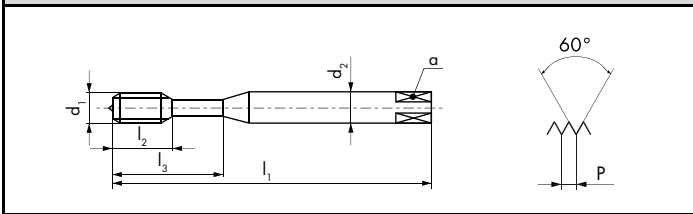

< 2.5 x D

< 2.5 x P

< 2.5 x P

ISO 1 4H

7G

7G

Ø d ₁ M	P mm	l ₁ mm	l ₂ mm	l ₃ mm	d ₂ mm	a mm		6H
3	0.5	56	5.5	18	3.5	2.7	3	2.5
4	0.7	63	7.5	21	4.5	3.4	3	3.3
5	0.8	70	9	25	6	4.9	3	4.2
6	1	80	11	30	6	4.9	3	5
8	1.25	90	12.5	35	8	6.2	3	^Δ 6.8
10	1.5	100	14	39	10	8	3	8.5

ID	ID 6H + mm	ID 6H + mm
● 101624	● 101628 0.036	● 144311 0.036
● 101633	● 101638 0.041	● 144192 0.041
● 101642	● 101647 0.044	● 143208 0.044
● 101651	● 101655 0.050	● 146709 0.050
● 101661	● 101667 0.052	● 146267 0.052
● 101610	● 101616 0.060	● 142547 0.060

6H
+0.1 mm



6H
+0.1 mm

Ø d ₁ M	P mm	l ₁ mm	l ₂ mm	l ₃ mm	d ₂ mm	a mm		6H +0.1
3	0.5	56	5.5	18	3.5	2.7	3	2.6
4	0.7	63	7.5	21	4.5	3.4	3	3.4
5	0.8	70	9	25	6	4.9	3	4.3
6	1	80	11	30	6	4.9	3	5.1
8	1.25	90	12.5	35	8	6.2	3	6.9
10	1.5	100	14	39	10	8	3	8.6

ID	ID
● 160847	
● 101636	● 146513
● 101645	● 146046
● 101653	● 145559
● 101664	● 143415
● 101613	● 124917

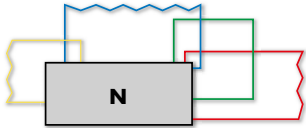

^Δ **ISO 1 4H** = 6.70









N460-3		63 72 73 74 81 91
N460V-3	 	11 12 32

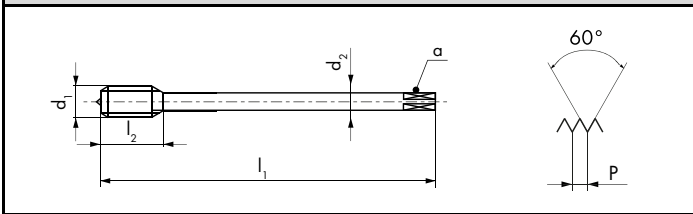

N460-3	N460-3	N460V-3	
--------	--------	---------	--







		
---	---	---













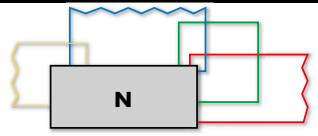



		
		

$\emptyset d_1$ M	P mm	l_1 mm	l_2 mm	d_2 mm	a mm		
12	1.75	110	14	9	7	3	10.2
16	2	110	18	12	9	3	14



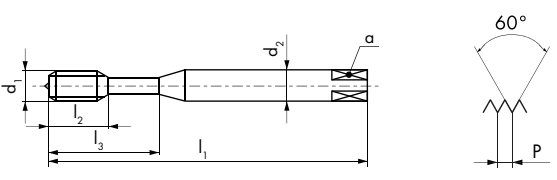





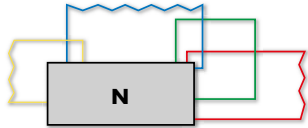

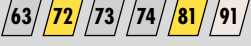





ID	ID ^{6H} + mm	ID ^{6H} + mm
* 124987	● 102363 0.066	● 142532 0.066
	● 102379 0.072	● 144956 0.072
		

$\emptyset d_1$ M	P mm	l_1 mm	l_2 mm	d_2 mm	a mm		
12	1.75	110	14	9	7	3	10.3
16	2	110	18	12	9	3	14.1

ID	ID
● 102360	● 125044
● 102377	● 145311

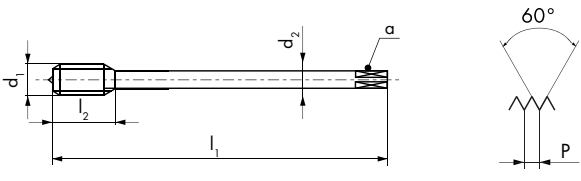
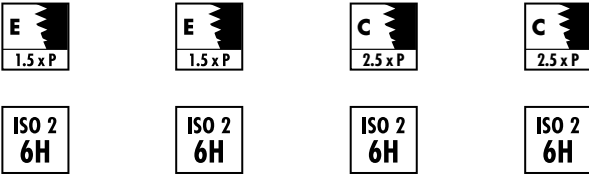
										N360-5	N360V-5	N361-3	N362V-3
<p>N360-5  63 72 73 74 81 91</p> <p>N360V-5   11 12 32</p> <p>N361-3   61 63 71 72 73 74 81 91</p> <p>N362V-3    11 12 32</p>													
													
													
													
Ø d ₁ M	P mm	l ₁ mm	l ₂ mm	l ₃ mm	d ₂ mm	a mm			ID	ID	ID	ID	
2	0.4	45	7		2.8	2.1	2	1.6	● 158079	● 150058			
3	0.5	56	5.5	18	3.5	2.7	3	2.5	● 104809	● 142646	● 101735		
4	0.7	63	7.5	21	4.5	3.4	3	3.3	● 104810	● 142647	● 101736	● 101741	
5	0.8	70	9	25	6	4.9	3	4.2	● 104811	● 142648	● 101737	● 101742	
6	1	80	11	30	6	4.9	3	5	● 104812	● 142649	● 101738	● 101743	
8	1.25	90	12.5	35	8	6.2	3	6.8	● 104813	● 142650	● 101739	● 101744	
10	1.5	100	14	39	10	8	3	8.5	● 104814	● 124899	● 101734	● 101740	



								N460-5	N460V-5	N461-3	N462V-3				
<p>N460-5  </p> <p>N460V-5   </p> <p>N461-3   </p> <p>N462V-3    </p>															
															
$\emptyset d_1$ M	P mm	l_1 mm	l_2 mm	d_2 mm	a mm			ID	ID	ID	ID				
12	1.75	110	14	9	7	3	10.2	● 104815	● 142651	● 102506	● 102512				
14	2	110	14	11	9	3	12				● 102513				
16	2	110	18	12	9	3	14				● 102514				
18	2.5	125	21	14	11	3	15.5			* 111614	● 102515				
20	2.5	140	24	16	12	4	17.5				● 102516				
24	3	160	27	18	14.5	4	21				● 102517				
27	3	160	27	20	16	4	24				● 159244				
30	3.5	180	30	22	18	4	26.5				● 143090				

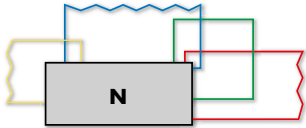

N520-4		62 63 64 72 73 74 81 91
N520V-4	V	11 12 31 32
N520TN-4	TiN	11 12 13 14 32

N520-4	N520V-4	N520TN-4

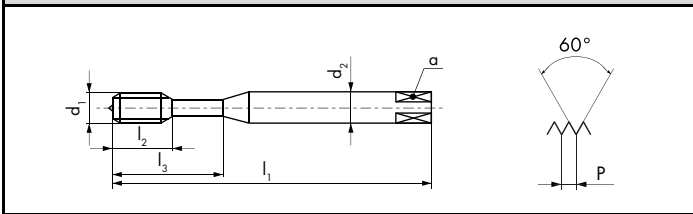





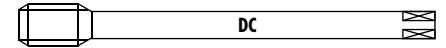

ISO 2 6H	ISO 2 6H	ISO 2 6H

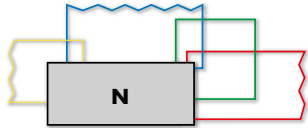





Ø d ₁ M	P mm	l ₁ mm	l ₂ mm	l ₃ mm	d ₂ mm	a mm			ID	ID	ID
2.5	0.45	100	10		2.8	2.1	3	2.05	● 102594	● 142623	
3	0.5	112	12	18	3.5	2.7	3	2.5	● 102595	● 143399	● 162790
4	0.7	112	14	21	4.5	3.4	3	3.3	● 102596	● 143400	● 146837
5	0.8	125	15	25	6	4.9	3	4.2	● 102597	● 142654	● 150113
6	1	125	17	30	6	4.9	3	5	● 102598	● 143137	● 148821







								N620-4	N620V-4	N620TN-4
N620-4										
N620V-4										
N620TN-4										
$\emptyset d_1$ M	P mm	l_1 mm	l_2 mm	d_2 mm	a mm			ID	ID	ID
4	0.7	112	14	2.8	2.1	3	3.3	● 102619	● 142582	● 146442
5	0.8	125	15	3.5	2.7	3	4.2	● 102620	● 142657	● 146443
6	1	125	17	4.5	3.4	3	5	● 102621	● 142658	● 144591
8	1.25	140	20	6	4.9	3	6.8	● 102622	● 143401	● 146262
10	1.5	160	22	7	5.5	3	8.5	● 102614	● 142660	● 146849
12	1.75	180	24	9	7	3	10.2	● 102615	● 143127	● 146295
14	2	180	28	11	9	3	12	● 102616	● 151905	
16	2	200	30	12	9	3	14	● 102617	● 143106	● 143574
20	2.5	224	36	16	12	3	17.5	● 102618	● 143596	● 174317



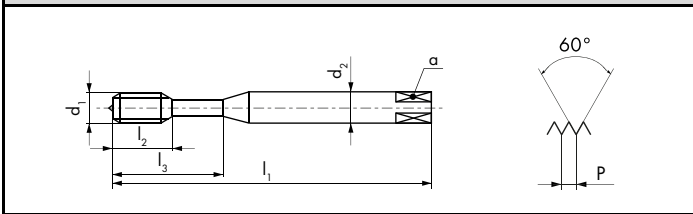

N560-3		63 72 73 74 81 91
N560V-3	 	11 12 32
N560TN-3	 	11 12 13 14 32

N560-3	N560V-3	N560TN-3
		
		







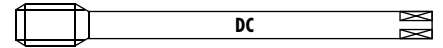



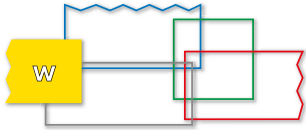
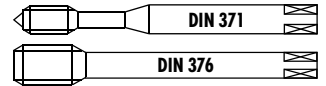

		
ISO 2 6H	ISO 2 6H	ISO 2 6H



Ø d ₁ M	P mm	l ₁ mm	l ₂ mm	l ₃ mm	d ₂ mm	a mm			ID	ID	ID
2.5	0.45	100	9		2.8	2.1	2	2.05	● 102600	● 102607	
3	0.5	112	5.5	18	3.5	2.7	3	2.5	● 102601	● 102608	● 142663
4	0.7	112	7.5	21	4.5	3.4	3	3.3	● 102602	● 102609	● 142664
5	0.8	125	9	25	6	4.9	3	4.2	● 102603	● 102610	● 142665
6	1	125	11	30	6	4.9	3	5	● 102604	● 102611	● 142666
8	1.25	140	12.5	35	8	6.2	3	6.8	● 102605	● 102612	● 142667
10	1.5	160	14	39	10	8	3	8.5	● 102599	● 102606	● 142668

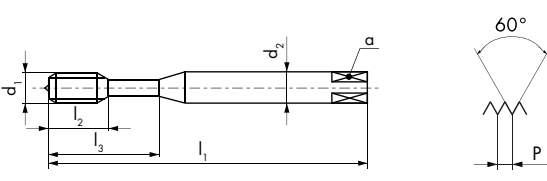
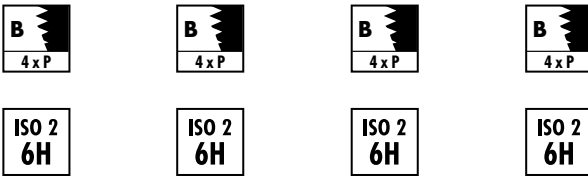

								N660-3	N660V-3	N660TN-3	
								N660-3 63 72 73 74 81 91			
N660V-3 11 12 32											
N660TN-3 11 12 13 14 32											
$\emptyset d_1$ M	P mm	l_1 mm	l_2 mm	d_2 mm	a mm			ID	ID	ID	
6	1	125	11	4.5	3.4	3	5	● 162792	● 115657		
8	1.25	140	12.5	6	4.9	3	6.8	● 162793	● 115544		
10	1.5	160	14	7	5.5	3	8.5	● 162794	● 135539	● 173484	
12	1.75	180	14	9	7	3	10.2	● 102623	● 102626	● 142669	
14	2	180	14	11	9	3	12	● 162253	● 147500		
16	2	200	18	12	9	3	14	● 102624	● 102627	● 142670	
20	2.5	224	24	16	12	4	17.5	● 102625	● 102628	● 178003	



										W320-4	W420-4	W320DL-4	W420DL-4
<p>W320-4  71 72 81</p> <p>W420-4  71 72 81</p> <p>W320DL-4   71 72 73</p> <p>W420DL-4   71 72 73</p>													
													
$\emptyset d_1$ M	P mm	l_1 mm	l_2 mm	l_3 mm	d_2 mm	a mm			ID	ID	ID	ID	
* 2	0.4	45	8		2.8	2.1	2	1.6	● 104612		● 176688		
2.5	0.45	50	10		2.8	2.1	2	2.05	● 104613		● 176689		
3	0.5	56	12	18	3.5	2.7	2	2.5	● 104615		● 176690		
4	0.7	63	14	21	4.5	3.4	2	3.3	● 104617		● 176691		
5	0.8	70	15	25	6	4.9	2	4.2	● 104618		● 176354		
6	1	80	17	30	6	4.9	2	5	● 104619		● 175590		
8	1.25	90	20		6	4.9	2	6.8		● 104636		● 176692	
10	1.5	100	22		7	5.5	2	8.5		● 104632		● 176693	
12	1.75	110	24		9	7	3	10.2		● 104633		● 176694	
16	2	110	30		12	9	3	14		● 104634		● 176695	

*W320-3 
 *W320DL-3 

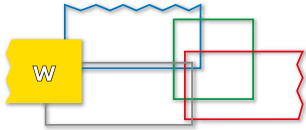
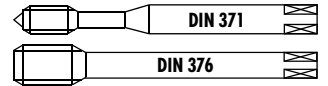

										W360-3	W460-3	W360DL-3	W460DL-3
W360-3 71 72 81													
W460-3 71 72 81													
W360DL-3 71 72 73													
W460DL-3 71 72 73													
Ø d ₁ M	P mm	l ₁ mm	l ₂ mm	l ₃ mm	d ₂ mm	a mm				ID	ID	ID	ID
2	0.4	45	7		2.8	2.1	2	1.6		● 104625		● 176719	
2.5	0.45	50	9		2.8	2.1	2	2.05		● 104626		● 176720	
3	0.5	56	5.5	18	3.5	2.7	2	2.5		● 104627		● 176721	
4	0.7	63	7.5	21	4.5	3.4	2	3.3		● 104628		● 176722	
5	0.8	70	9	25	6	4.9	2	4.2		● 104629		● 176723	
6	1	80	11	30	6	4.9	2	5		● 104630		● 176355	
8	1.25	90	12.5	35	8	6.2	2	6.8		● 104631		● 176724	
10	1.5	100	14	39	10	8	2	8.5		● 104624		● 176725	
12	1.75	110	14		9	7	3	10.2			● 104640		● 176726
16	2	110	18		12	9	3	14			● 104641		● 176727

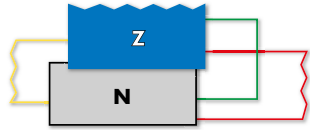
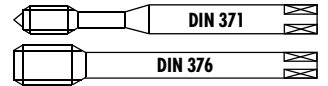

Z320V-4		V	11 12 13 21 32
Z420V-4		V	11 12 13 21 32
Z320VS-4		VS	11 12 13 14 21 22 23 32 61 63 94
Z420VS-4		VS	11 12 13 14 21 22 23 32 61 63 94

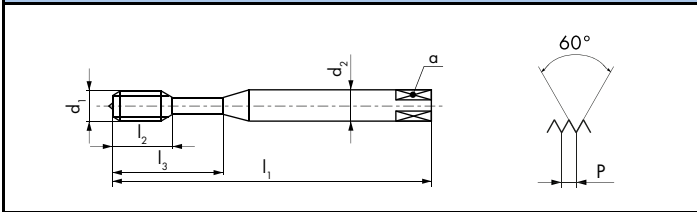
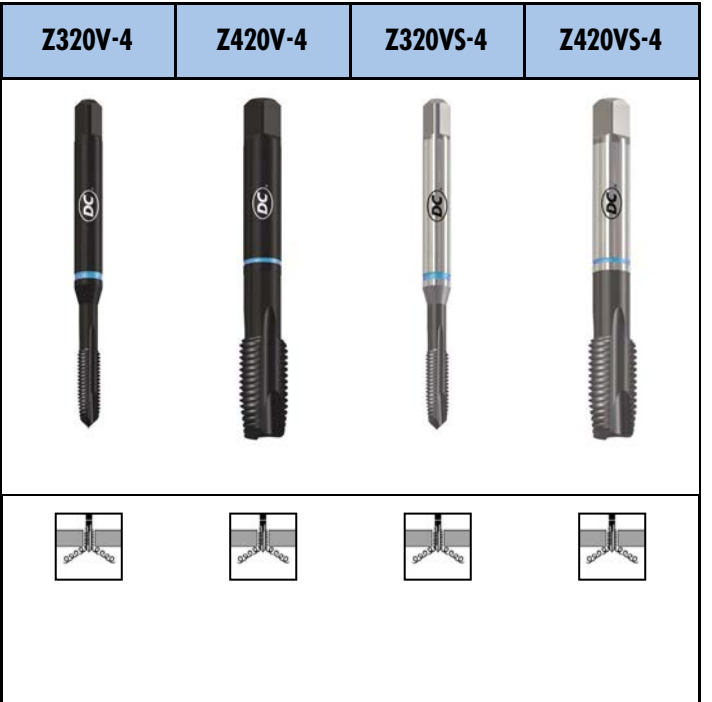

ISO 2 6H	ISO 2 6H	ISO 2 6H	ISO 2 6H

Ø d ₁ M	P mm	l ₁ mm	l ₂ mm	l ₃ mm	d ₂ mm	a mm			ID	ID	ID	ID
* 1.6	0.35	40	8		2.5	2.1	2	1.25	● 142671			
* 2	0.4	45	8		2.8	2.1	2	1.6	● 111613			
2.5	0.45	50	10		2.8	2.1	3	2.05	● 111455		● 143683	
2.6	0.45	50	10		2.8	2.1	3	2.15	● 142672			
3	0.5	56	12	18	3.5	2.7	3	2.5	● 104669		● 104830	
4	0.7	63	14	21	4.5	3.4	3	3.3	● 104670		● 104831	
5	0.8	70	15	25	6	4.9	3	4.2	● 104671		● 104832	
6	1	80	17	30	6	4.9	3	5	● 104672		● 104833	
8	1.25	90	20	35	8	6.2	3	6.8	● 104673		● 104834	
10	1.5	100	22	39	10	8	3	8.5	● 104668		● 104835	
12	1.75	110	24		9	7	3	10.2		● 104723		● 104836
14	2	110	28		11	9	3	12		● 142673		● 143684
16	2	110	30		12	9	3	14		● 105068		● 111569
18	2.5	125	33		14	11	4	15.5		● 142674		
20	2.5	140	36		16	12	4	17.5		● 105069		● 111570
22	2.5	140	36		18	14.5	4	19.5		● 146003		
24	3	160	39		18	14.5	4	21		● 142675		● 150017
30	3.5	180	45		22	18	4	26.5		● 142676		

*Z320V-3

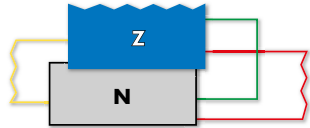
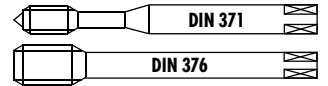

Z360V-3



12 21 32

Z362V-3



12 21 32

Z462V-3



12 21 32

Z360V-3

Z362V-3

Z462V-3

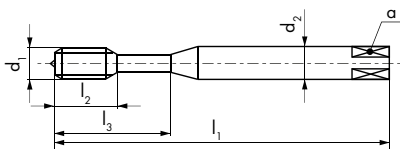

Ø d ₁ M	P mm	l ₁ mm	l ₂ mm	l ₃ mm	d ₂ mm	a mm		
2	0.4	45	7		2.8	2.1	2	1.6
2.5	0.45	50	9		2.8	2.1	2	2.05
2.6	0.45	50	9		2.8	2.1	2	2.15
3	0.5	56	5.5	18	3.5	2.7	3	2.5
3.5	0.6	56	6.5	20	4	3	3	2.9
4	0.7	63	7.5	21	4.5	3.4	3	3.3
5	0.8	70	9	25	6	4.9	3	4.2
6	1	80	11	30	6	4.9	3	5
8	1.25	90	12.5	35	8	6.2	3	6.8
10	1.5	100	14	39	10	8	3	8.5
12	1.75	110	14		9	7	3	10.2
14	2	110	14		11	9	3	12
16	2	110	18		12	9	3	14
18	2.5	125	21		14	11	3	15.5
20	2.5	140	24		16	12	3	17.5
22	2.5	140	24		18	14.5	3	19.5
24	3	160	27		18	14.5	4	21
27	3	160	27		20	16	4	24
30	3.5	180	30		22	18	4	26.5
36	4	200	36		28	22	4	32
42	4.5	200	40		32	24	4	37.5

ID

ID

ID

● 104684

● 104685

● 104686

● 104687

● 104688

● 104689

● 104690

● 104691

● 104692

● 104683

● 104742

● 104743

● 104744

● 104745

● 104746

● 104752

● 104747

● 104748

● 104749

● 104750

● 104751

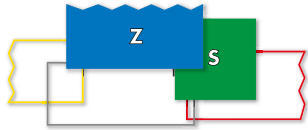

Z362VS-3				12 14 21 22 23 32 61 63	
Z370VS-3				14 15 21 22 23 24 51 61	
Z373VS-3					94
Z370VS-3				13 14 15 21 22 23 24 51	
Z373VS-3					52

Z362VS-3	Z370VS-3	Z370VS-3	Z373VS-3
----------	----------	----------	----------



< 2.5 x D	< 3 x D	< 3 x D	< 3 x D
	PM	PM	PM

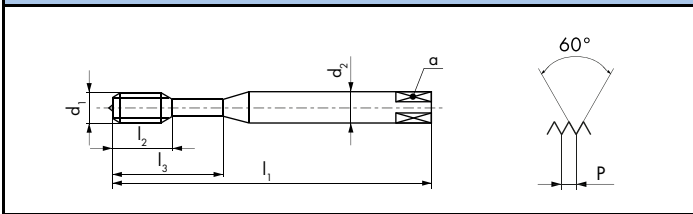

6HX	6HX	4HX	6HX

$\emptyset d_1$ M	P mm	l_1 mm	l_2 mm	l_3 mm	d_2 mm	a mm			ID
* 3	0.5	56	5.5	18	3.5	2.7	3	2.5	● 111504
4	0.7	63	7.5	21	4.5	3.4	3	3.3	● 111505
5	0.8	70	9	25	6	4.9	3	4.2	● 111506
6	1	80	11	30	6	4.9	3	5	● 111507
8	1.25	90	12.5	35	8	6.2	3	6.8	● 111508
10	1.5	100	14	39	10	8	3	8.5	● 111509
*Z360VS-3									

$\emptyset d_1$ M	P mm	l_1 mm	l_2 mm	l_3 mm	d_2 h6 mm	a mm			ID	ID	ID
3	0.5	56	5.5	18	3.5(h9)	2.7	3	2.5	● 162776	● 165324	● 165236
4	0.7	63	7.5	21	4.5(h9)	3.4	3	3.3	● 162777	● 165325	● 165237
5	0.8	70	9	25	6	4.9	3	4.2	● 162778	● 165326	● 165238
6	1	80	11	30	6	4.9	3	5	● 162779	● 165327	● 165239
8	1.25	90	12.5	35	8	6.2	3	Δ 6.8	● 162780	● 165328	● 165240
10	1.5	100	14	39	10	8	3	8.5	● 162781	● 165438	● 165241

Δ **4HX** = 6.7

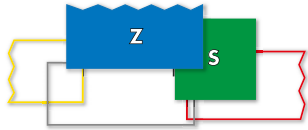

Z462VS-3				12 14 21 22 23 32 61 63
Z470VS-3				14 15 21 22 23 24 51 61
Z473VS-3				94
Z470VS-3				13 14 15 21 22 23 24 51
Z473VS-3				52

Z462VS-3	Z470VS-3	Z473VS-3	
< 2.5 x D	< 3 x D	< 3 x D	
	PM	PM	

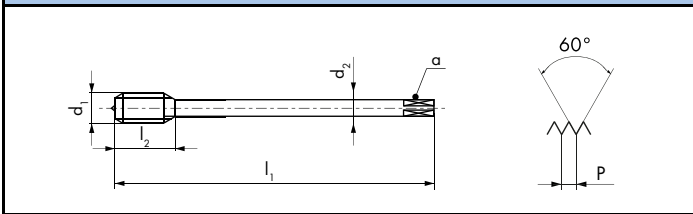

Z462VS-3	Z470VS-3	Z473VS-3
6HX	6HX	6HX

Ø d ₁ M	P mm	l ₁ mm	l ₂ mm	d ₂ mm	a mm			ID
12	1.75	110	14	9	7	4	10.2	● 111510
14	2	110	14	11	9	4	12	★ 148169
16	2	110	18	12	9	4	14	● 111511
20	2.5	140	24	16	12	4	17.5	● 111512
24	3	160	27	18	14.5	4	21	★ 111620

ID	ID
● 111510	● 162782
★ 148169	● 162783
● 111511	● 162784
● 111512	● 170643
★ 111620	● 162785
	● 175190
	● 162786
	● 165242
	● 165244
	● 165234
	● 165235

Ø d ₁ M	P mm	l ₁ mm	l ₂ mm	d ₂ h6 mm	a mm			ID	ID
12	1.75	110	14	* 10	* 8	4	10.2	● 162782	● 165242
14	2	110	14	* 12	* 9	4	12	● 162783	
16	2	110	18			4	14	● 162784	● 165244
18	2.5	125	21			4	15.5	● 170643	
20	2.5	140	24			4	17.5	● 162785	● 165234
22	2.5	140	24			4	19.5	● 175190	
24	3	160	27			4	21	● 162786	● 165235

* Norme DC / * DC Norm/ * Norma DC

ZX AMPCO®

ALLIAGES D'ALU-BRONZE

LEGHE DI ALLUMINIO-BRONZO



ZX - Tarauds à machine DC avec une géométrie de coupe spécialement adaptée

Pour trous traversants et borgnes < 1.5 x D

Optimale
pour AMPCO® 21 / 22
Dureté HB > 280 - < 330

Fonctionnelle
pour AMPCO® 18
Dureté HB < 420

Fonctionnelle
pour AMPCO® 25 / 26
Dureté HB < 420

Recommandation
Pour AMPCO® 25 / 26 : Ø de perçage + 0.2 mm

Autres options pour travailler de l'AMPCO® :

Optimale
Pour trous traversants

Tarauds à machine DC type H320-4 / H420-4 pour AMPCO® 18
Dureté HB < 200

Optimale
Pour trous traversants et borgnes < 2 x D

pour AMPCO® 25 / 26
Dureté HB > 380 - < 420
Lubrifiant : huile de coupe / émulsion

Fraise à fileter en carbure monobloc, type DC GF6165VS
Vitesse de coupe Vc : 30 - 50 m/min
Avance fraisage fz : 0.01 - 0.05 mm/dent

Optimale
Pour trous traversants et borgnes < 4 x D

pour AMPCO® 25 / 26
Dureté HB > 380 - < 420
Lubrifiant : huile de coupe / émulsion

Fraises à tourbillonner en carbure monobloc, type DC GW301.VS / GWi306.VS
Vitesse de coupe Vc : 30 - 50 m/min
Avance fraisage fz : 0.01 - 0.08 mm/dent

ZX - Maschi a macchina DC con geometria di taglio appositamente adattata

Per fori passanti e ciechi < 1.5 x D

Ottimale
per AMPCO® 21 / 22
Durezza HB > 280 - < 330

Funzionale
per AMPCO® 18
Durezza HB < 420

Funzionale
per AMPCO® 25 / 26
Durezza HB < 420

Raccomandazione
Per AMPCO® 25 / 26 : Ø del preforo + 0.2 mm

Ulteriori opzioni per la lavorazione dell'AMPCO® :

Ottimale
Per fori passanti

Maschi a macchina DC tipo H320-4 / H420-4 per AMPCO® 18
Durezza HB < 200

Ottimale
Per fori passanti e ciechi < 2 x D

per AMPCO® 25 / 26
Durezza HB > 380 - < 420
Lubrificante: olio da taglio / emulsione

Frese a filettare in metallo duro integrale, tipo DC GF6165VS
Velocità di taglio Vc: 30 - 50 m/min
Avanzamento fz: 0.01 - 0.05 mm/dente

Ottimale
Per fori passanti e ciechi < 4 x D

per AMPCO® 25 / 26
Durezza HB > 380 - < 420
Lubrificante: olio da taglio / emulsione

Frese a filettare vorticoso in metallo duro integrale, tipo GW301.VS / GWi306.VS
Velocità di taglio Vc: 30 - 50 m/min
Avanzamento fz: 0.01 - 0.08 mm/dente

ZX

ZX320-4			AMPCO® 21 22
ZX420-4			AMPCO® 21 22
ZX320-4			AMPCO® 18 25 26
ZX420-4			AMPCO® 18 25 26

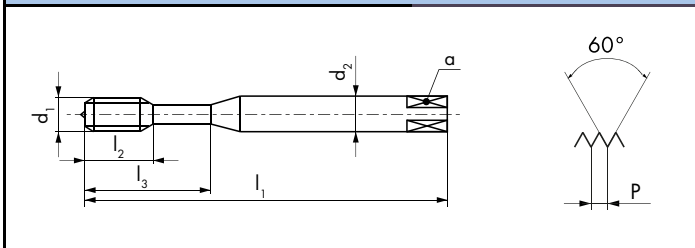
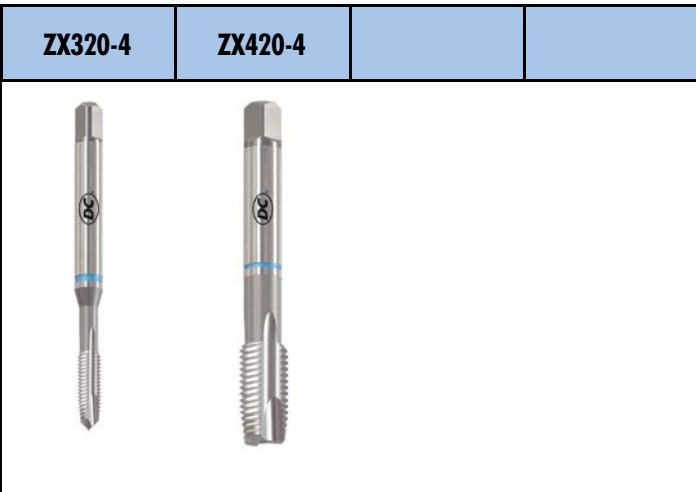

6HX	6HX

Ø d ₁ M	P mm	l ₁ mm	l ₂ mm	l ₃ mm	d ₂ mm	a mm			ID
4	0.7	63	14	21	4.5	3.4	3	* 3.3	● 143599
5	0.8	70	15	25	6	4.9	3	* 4.2	● 145458
6	1	80	17	30	6	4.9	3	* 5	● 110232
8	1.25	90	20	35	8	6.2	3	* 6.8	● 110233
10	1.5	100	22	39	10	8	3	* 8.5	● 124905

Ø d ₁ M	P mm	l ₁ mm	l ₂ mm	d ₂ mm	a mm			ID
12	1.75	110	24	9	7	3	* 10.2	● 110208
16	2	110	30	12	9	3	* 14	● 110207

*Ampco® 25 / Ampco® 26 + 0.2 mm

TABELLE D'UTILISATION POUR ALLIAGES D'ALU-BRONZE TABELLA D'IMPIEGO PER LEGHE DI ALLUMINIO-BRONZO

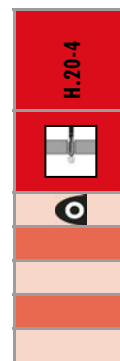
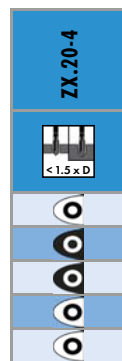

Groupes de matières Gruppi di materiali	Dureté Durezza (HB)	Vitesse de coupe Velocità di taglio V _c (m/min) Guide Line
AMPCO® 18	< 290	6 - 10
AMPCO® 21	> 280 - < 330	2 - 3
AMPCO® 22	> 280 - < 330	2 - 3
AMPCO® 25	< 420	2 - 3
AMPCO® 26	< 420	2 - 3

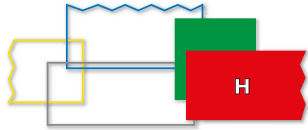

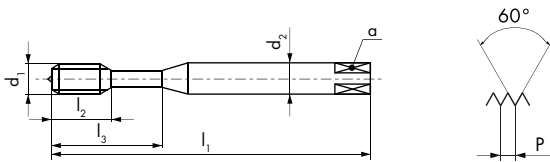

H320-4

15 16 62 64 82
H320TC-4

TiCN
15 16 24 31 82 83
92 93
H320-4
H320TC-4

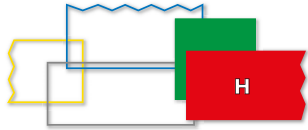
$\emptyset d_1$ M	P mm	l_1 mm	l_2 mm	l_3 mm	d_2 mm	a mm			ID	ID
2	0.4	45	8		2.8	2.1	2	1.6	● 101206	● 151836
2.2	0.45	45	9		2.8	2.1	2	1.75	● 111801	
2.5	0.45	50	10		2.8	2.1	3	2.05	● 101207	● 148603
3	0.5	56	12	18	3.5	2.7	3	2.5	● 101209	● 111836
3.5	0.6	56	13	20	4	3	3	2.9	● 101210	
4	0.7	63	14	21	4.5	3.4	3	3.3	● 101211	● 111502
4.5	0.75	70	15	25	6	4.9	3	3.75	● 101212	
5	0.8	70	15	25	6	4.9	3	4.2	● 101213	● 111458
6	1	80	17	30	6	4.9	3	5	● 101215	● 111456
8	1.25	90	20	35	8	6.2	3	6.8	● 101218	● 111453
10	1.5	100	22	39	10	8	3	8.5	● 101205	● 110911



H420-4		15 16 62 64 82
H420TC-4	TiCN	15 16 24 31 82 83 92 93

H420-4	H420TC-4		
---------------	-----------------	--	--

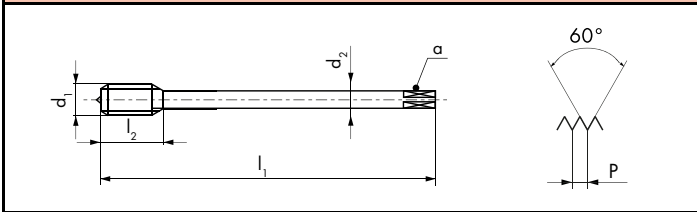
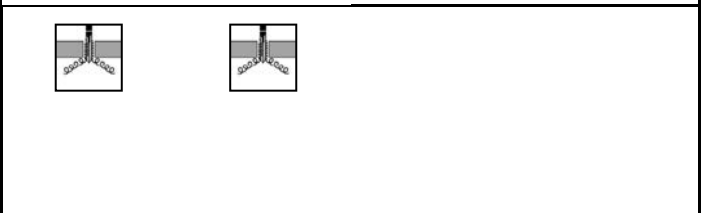

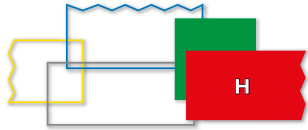

B 4 x P	B 4 x P
ISO 2 6H	ISO 2 6H

Ø d ₁ M	P mm	l ₁ mm	l ₂ mm	d ₂ mm	a mm			ID	ID
12	1.75	110	24	9	7	4	10.2	● 101275	● 110912
14	2	110	28	11	9	4	12	● 101277	● 145461
16	2	110	30	12	9	4	14	● 101279	● 111612
18	2.5	125	33	14	11	4	15.5	● 101281	
20	2.5	140	36	16	12	4	17.5	● 101284	● 144606
22	2.5	140	36	18	14.5	4	19.5	● 157752	
24	3	160	39	18	14.5	4	21	● 101286	● 143588
27	3	160	42	20	16	4	24	● 101287	
30	3.5	180	45	22	18	4	26.5	● 101288	
36	4	200	51	28	22	4	32	● 101289	









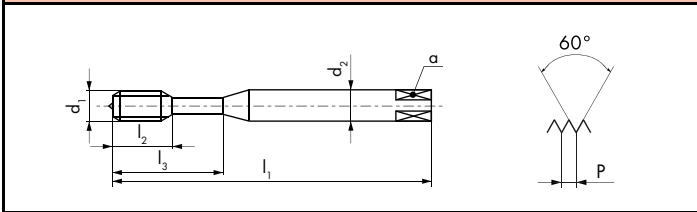
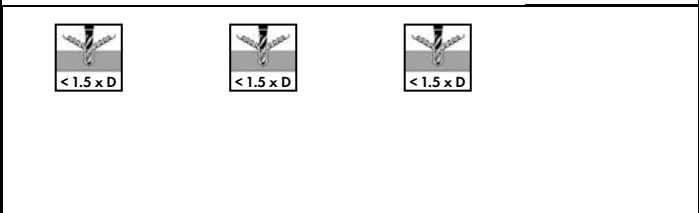

H350-3  **15 16 62 64 82**

H350TC-3   **15 16 24 31 82 83**
92 93

H350-3	H350-3	H350TC-3	
--------	--------	----------	--



$\emptyset d_1$ M	P mm	l_1 mm	l_2 mm	l_3 mm	d_2 mm	a mm			ID	ID	6H + mm	ID
2	0.4	45	7		2.8	2.1	2	1.6	● 101238			● 146451
2.5	0.45	50	9		2.8	2.1	3	2.05	● 101239			● 144957
3	0.5	56	5.5	18	3.5	2.7	3	2.5	● 101242	● 101241	0.020	● 111835
3.5	0.6	56	6.5	20	4	3	3	2.9	● 101243			
4	0.7	63	7.5	21	4.5	3.4	3	3.3	● 101245	● 101244	0.022	● 111607
4.5	0.75	70	9	25	6	4.9	3	3.75	● 101246			
5	0.8	70	9	25	6	4.9	3	4.2	● 101248	● 101247	0.024	● 111610
6	1	80	11	30	6	4.9	3	5	● 101251	● 101250	0.026	● 111500
8	1.25	90	12.5	35	8	6.2	3	6.8	● 101255	● 101254	0.028	● 110963
10	1.5	100	14	39	10	8	3	8.5	● 101237	● 101236	0.032	● 111454

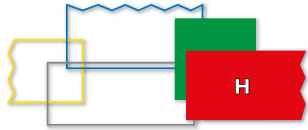

H450-3



15 16 62 64 82

H450TC-3

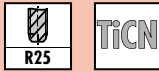



15 16 24 31 82 83
92 93

H450-3

H450-3

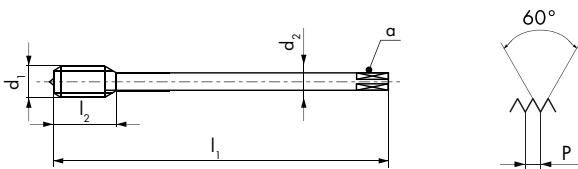
H450TC-3



Ø d ₁ M	P mm	l ₁ mm	l ₂ mm	d ₂ mm	a mm		
12	1.75	110	14	9	7	4	10.2
14	2	110	14	11	9	4	12
16	2	110	18	12	9	4	14
18	2.5	125	21	14	11	4	15.5
20	2.5	140	24	16	12	4	17.5
22	2.5	140	24	18	14.5	4	19.5
24	3	160	27	18	14.5	4	21
27	3	160	27	20	16	4	24
30	3.5	180	30	22	18	4	26.5
36	4	200	36	28	22	4	32
42	4.5	200	40	32	24	4	37.5

ID	ID	6H + mm	ID
● 101305	★ 101304	0.034	● 111501
● 101307			● 146151
● 101309			● 111605
● 101311			
● 101313			● 144986
● 101315			
● 101318			● 144987
● 101320			
● 101323			
● 101324			
● 101325			

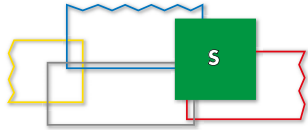
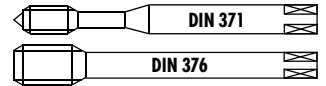

S320VS-4



13 15 16 22 23 24
52

S420VS-4



13 15 16 22 23 24
52

S320VS-4

S320VS-4

S420VS-4

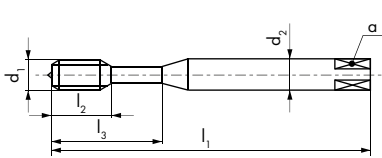

6HX

4HX

6HX

$\emptyset d_1$ M	P mm	l_1 mm	l_2 mm	l_3 mm	d_2 mm	a mm		
3	0.5	56	12	18	3.5	2.7	3	2.5
4	0.7	63	14	21	4.5	3.4	3	3.3
5	0.8	70	15	25	6	4.9	3	4.2
6	1	80	17	30	6	4.9	3	5
8	1.25	90	20	35	8	6.2	3	Δ 6.8
10	1.5	100	22	39	10	8	3	8.5
12	1.75	110	24		9	7	4	10.2
16	2	110	30		12	9	4	14
20	2.5	140	36		16	12	4	17.5

ID

ID

ID

- 111596 * 165318
- 111597 * 165319
- 111598 * 165320
- 111599 * 165321
- 111600 * 165322
- 111601 * 165323

- 111602
- 111603
- 111604

Δ 4HX = 6.7

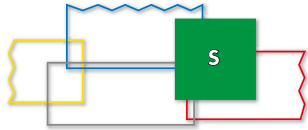
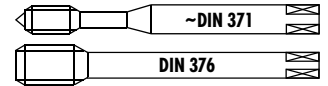

S360VS-3



13 15 16 22 23 24
52

S460VS-3



13 15 16 22 23 24
52

aero

SA390-3



16 53

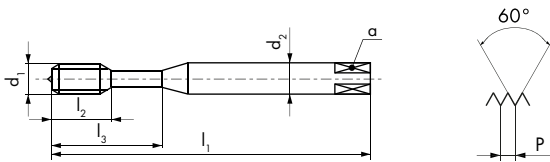

S360VS-3

S460VS-3

SA390-3

SA390-3





6HX

6HX

4HX

6HX

$\emptyset d_1$ M	P mm	l_1 mm	l_2 mm	l_3 mm	d_2 mm	a mm		
3	0.5	56	5.5	18	3.5	2.7	3	2.5
4	0.7	63	7.5	21	4.5	3.4	3	3.3
5	0.8	70	9	25	6	4.9	3	4.2
6	1	80	11	30	6	4.9	3	5
8	1.25	90	12.5	35	8	6.2	3	6.8
10	1.5	100	14	39	10	8	3	8.5
12	1.75	110	14		9	7	4	10.2
14	2	110	14		11	9	4	12
16	2	110	18		12	9	4	14
20	2.5	140	24		16	12	4	17.5
24	3	160	27		18	14.5	4	21

ID

ID

- 111513
- 111514
- 111515
- 111516
- 111517
- 111518



- 111519

- * 148171

- 111520

- 111521

- 111606

$\emptyset d_1$ M	P mm	l_1 mm	l_2 mm	d_2 mm	a mm		
4	0.7	63	14	4.5	3.4	3	3.3
5	0.8	70	15	6	4.9	3	4.2
6	1	80	20	6	4.9	3	5
8	1.25	90	25	8	6.2	3	Δ 6.8
10	1.5	100	30	10	8	3	8.5
12	1.75	110	35	12	9	4	10.2
14	2	110	40	16	12	4	12

ID

ID

- 149673

- 149674

- 149693

- 149694

- 149707

- 149708

- 149736

- 149737

- * 149754

- 149755

- 149775

- 149775

























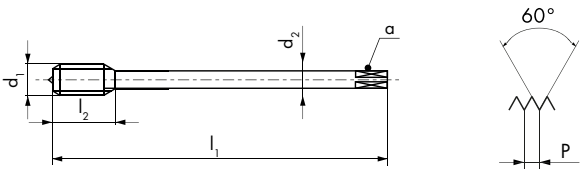





- * 149792

Δ 4HX = 6.7

aero

										SA320-4	SA350-3	TL320VS-4	TL351VS-3						
<div style="display: flex; justify-content: space-between;"> <div style="width: 45%;"> <p>SA320-4 15 16 52 64</p> <p>SA350-3 15 16 52 64</p> </div> <div style="width: 50%; text-align: center;"> </div> </div>										<div style="display: flex; justify-content: space-around;"> </div>									
<div style="display: flex; justify-content: space-between;"> <div style="width: 45%;"> <p>TL320VS-4 VS 41 42</p> <p>TL351VS-3 VS 41 42</p> </div> <div style="width: 50%; text-align: center;"> </div> </div>										<div style="display: flex; justify-content: space-around;"> </div>									
										<div style="display: flex; justify-content: space-around;"> <div style="text-align: center;"> <p>B 4 x P</p> <p>4HX</p> </div> <div style="text-align: center;"> <p>C 2.5 x P</p> <p>4HX</p> </div> <div style="text-align: center;"> <p>B 4 x P</p> <p>4HX</p> </div> <div style="text-align: center;"> <p>C 2.5 x P</p> <p>4HX</p> </div> </div>									
$\emptyset d_1$	P	l_1	l_2	l_3	d_2	a				ID	ID	ID	ID						
M	mm	mm	mm	mm	mm	mm													
3	0.5	56	12		3.5	2.7	3	2.5	● 147975	● 147987	● 152006	● 152012							
4	0.7	63	14		4.5	3.4	3	3.3	● 147976	● 147988	● 152007	● 152013							
5	0.8	70	15		6	4.9	3	4.2	● 147977	● 147989	● 152008	● 152014							
6	1	80	15	23	6	4.9	3	5	● 147978	● 147990	● 152009	● 152015							
8	1.25	90	18	29	8	6.2	3	6.7	● 147979	● 147991	● 152010	● 152016							
10	1.5	100	20	33	10	8	3	8.5	● 147980	● 147992	● 152011	● 152017							
										6HX	6HX	6HX	6HX						
$\emptyset d_1$	P	l_1	l_2	l_3	d_2	a				ID	ID	ID	ID						
M	mm	mm	mm	mm	mm	mm													
3	0.5	56	12		3.5	2.7	3	2.5	● 147981	● 147993	● 148001	● 148000							
4	0.7	63	14		4.5	3.4	3	3.3	● 147982	● 147994	● 148003	● 148002							
5	0.8	70	15		6	4.9	3	4.2	● 147983	● 147995	● 148007	● 148006							
6	1	80	15	23	6	4.9	3	5	● 147984	● 147996	● 148011	● 148010							
8	1.25	90	18	29	8	6.2	3	6.8	● 147985	● 147997	● 148020	● 148018							
10	1.5	100	20	33	10	8	3	8.5	● 147986	● 147998	● 148027	● 148025							

aero

									SA420-4	SA450-3	TL420VS-4	TL451VS-3																																																					
<div style="display: flex; justify-content: space-between;"> <div style="width: 45%;"> <p>SA420-4  15 16 52 64</p> <p>SA450-3  R15 15 16 52 64</p> </div> <div style="width: 45%; text-align: center;">     </div> </div>																																																																	
<div style="display: flex; justify-content: space-between;"> <div style="width: 45%;"> <p>TL420VS-4  VS 41 42</p> <p>TL451VS-3  R15  VS 41 42</p> </div> <div style="width: 45%; text-align: center;">      </div> </div>																																																																	
									<div style="display: flex; justify-content: space-around;"> <div style="text-align: center;"> 4HX</div> <div style="text-align: center;"> 4HX</div> <div style="text-align: center;"> 4HX</div> <div style="text-align: center;"> 4HX</div> </div>																																																								
<table border="1" style="width: 100%; border-collapse: collapse;"> <thead> <tr> <th>Ø d₁ M</th> <th>P mm</th> <th>l₁ mm</th> <th>l₂ mm</th> <th>d₂ mm</th> <th>a mm</th> <th></th> <th></th> </tr> </thead> <tbody> <tr> <td>12</td> <td>1.75</td> <td>110</td> <td>24</td> <td>9</td> <td>7</td> <td>4</td> <td>10.2</td> </tr> <tr> <td>14</td> <td>2</td> <td>110</td> <td>28</td> <td>11</td> <td>9</td> <td>4</td> <td>12</td> </tr> <tr> <td>16</td> <td>2</td> <td>110</td> <td>30</td> <td>12</td> <td>9</td> <td>4</td> <td>14</td> </tr> </tbody> </table>									Ø d ₁ M	P mm	l ₁ mm	l ₂ mm	d ₂ mm	a mm			12	1.75	110	24	9	7	4	10.2	14	2	110	28	11	9	4	12	16	2	110	30	12	9	4	14	<table border="1" style="width: 100%; border-collapse: collapse;"> <thead> <tr> <th>ID</th> <th>ID</th> <th>ID</th> <th>ID</th> </tr> </thead> <tbody> <tr> <td>* 148096</td> <td>* 152189</td> <td>* 152192</td> <td>* 152195</td> </tr> <tr> <td>* 152187</td> <td></td> <td></td> <td></td> </tr> <tr> <td>* 152188</td> <td></td> <td></td> <td>* 152197</td> </tr> </tbody> </table>									ID	ID	ID	ID	* 148096	* 152189	* 152192	* 152195	* 152187				* 152188			* 152197
Ø d ₁ M	P mm	l ₁ mm	l ₂ mm	d ₂ mm	a mm																																																												
12	1.75	110	24	9	7	4	10.2																																																										
14	2	110	28	11	9	4	12																																																										
16	2	110	30	12	9	4	14																																																										
ID	ID	ID	ID																																																														
* 148096	* 152189	* 152192	* 152195																																																														
* 152187																																																																	
* 152188			* 152197																																																														
									<div style="display: flex; justify-content: space-around;"> <div style="border: 1px solid black; padding: 5px;">6HX</div> <div style="border: 1px solid black; padding: 5px;">6HX</div> <div style="border: 1px solid black; padding: 5px;">6HX</div> <div style="border: 1px solid black; padding: 5px;">6HX</div> </div>																																																								
<table border="1" style="width: 100%; border-collapse: collapse;"> <thead> <tr> <th>Ø d₁ M</th> <th>P mm</th> <th>l₁ mm</th> <th>l₂ mm</th> <th>d₂ mm</th> <th>a mm</th> <th></th> <th></th> </tr> </thead> <tbody> <tr> <td>12</td> <td>1.75</td> <td>110</td> <td>24</td> <td>9</td> <td>7</td> <td>4</td> <td>10.2</td> </tr> <tr> <td>14</td> <td>2</td> <td>110</td> <td>28</td> <td>11</td> <td>9</td> <td>4</td> <td>12</td> </tr> <tr> <td>16</td> <td>2</td> <td>110</td> <td>30</td> <td>12</td> <td>9</td> <td>4</td> <td>14</td> </tr> </tbody> </table>									Ø d ₁ M	P mm	l ₁ mm	l ₂ mm	d ₂ mm	a mm			12	1.75	110	24	9	7	4	10.2	14	2	110	28	11	9	4	12	16	2	110	30	12	9	4	14	<table border="1" style="width: 100%; border-collapse: collapse;"> <thead> <tr> <th>ID</th> <th>ID</th> <th>ID</th> <th>ID</th> </tr> </thead> <tbody> <tr> <td>* 152198</td> <td>* 152201</td> <td>* 152204</td> <td>● 148028</td> </tr> <tr> <td>* 152199</td> <td></td> <td></td> <td>● 152207</td> </tr> <tr> <td></td> <td>* 152203</td> <td></td> <td>● 148029</td> </tr> </tbody> </table>									ID	ID	ID	ID	* 152198	* 152201	* 152204	● 148028	* 152199			● 152207		* 152203		● 148029
Ø d ₁ M	P mm	l ₁ mm	l ₂ mm	d ₂ mm	a mm																																																												
12	1.75	110	24	9	7	4	10.2																																																										
14	2	110	28	11	9	4	12																																																										
16	2	110	30	12	9	4	14																																																										
ID	ID	ID	ID																																																														
* 152198	* 152201	* 152204	● 148028																																																														
* 152199			● 152207																																																														
	* 152203		● 148029																																																														

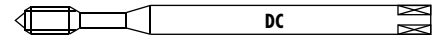
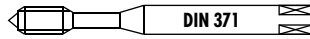

										GG350NV-3	GG350TC-3	GG353TC-3	GG550NV-3
GG350NV-3													
GG350TC-3													
GG353TC-3													
GG550NV-3													
$\emptyset d_1$ M	P mm	l_1 mm	l_2 mm	l_3 mm	d_2 mm	a mm			ID	ID			
3	0.5	56	12	18	3.5	2.7	3	2.5	● 101172	● 101178			
4	0.7	63	14	21	4.5	3.4	3	3.3	● 101173	● 101179			
5	0.8	70	15	25	6	4.9	3	4.2	● 101174	● 101180			
6	1	80	17	30	6	4.9	3	5	● 101175	● 101181			
8	1.25	90	20	35	8	6.2	4	6.8	● 101076	● 101182			
10	1.5	100	22	39	10	8	4	8.5	● 101171	● 101177			
$\emptyset d_1$ M	P mm	l_1 mm	l_2 mm	l_3 mm	d_2 h6 mm	a mm			ID				
5	0.8	70	15	25	6	4.9	3	4.2	● 144947				
6	1	80	17	30	6	4.9	3	5	● 147710				
8	1.25	90	20	35	8	6.2	4	6.8	● 147711				
10	1.5	100	22	39	10	8	4	8.5	● 146708				
$\emptyset d_1$ M	P mm	l_1 mm	l_2 mm	l_3 mm	d_2 mm	a mm			ID				
4	0.7	112	14	21	4.5	3.4	3	3.3	● 101196				
5	0.8	125	15	25	6	4.9	3	4.2	● 101197				
6	1	125	17	30	6	4.9	3	5	● 101198				

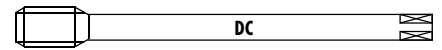

									GG450NV-3	GG450TC-3	GG453TC-3	GG650NV-3
GG450NV-3												
GG450TC-3												
GG453TC-3												
GG650NV-3												

K

K313TC-3

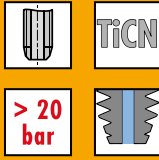

K413TC-3

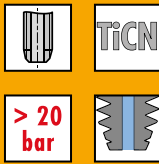

K313TC-3

K413TC-3

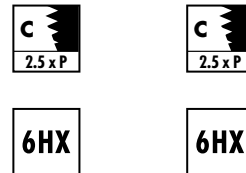
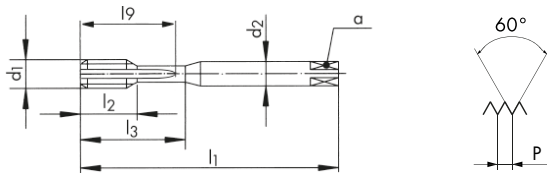

$\emptyset d_1$ M	P mm	l_1 mm	l_2 mm	l_3 mm	l_9 mm	d_2 mm	a mm		
5	0.8	70	15	25	23	6	4.9	3	4.2
6	1	80	17	30	28	6	4.9	3	5
8	1.25	90	20	35	33	8	6.2	3	6.8
10	1.5	100	22	39	37	10	8	3	8.5
12	1.75	110	24		42	9	7	3	10.2
14	2	110	28		49	11	9	3	12
16	2	110	30		56	12	9	4	14
20	2.5	140	36		70	16	12	5	17.5
24	3	160	39		84	18	14.5	5	21

ID

ID

- 175961
- 170766
- 170769
- 170772
- 165838
- 170778
- 170783
- 170786
- 170775

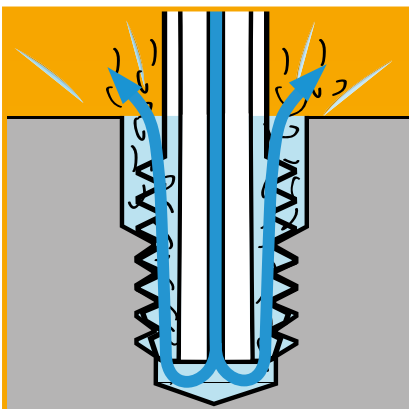



≤ Ø 25.4 > Ø 25.4

PM HSSE

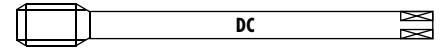

K

K613TC-3

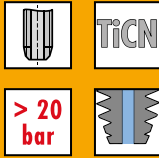

K613VS-3

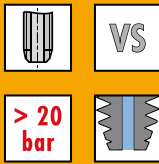

K613TC-3

K613VS-3

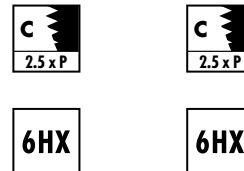
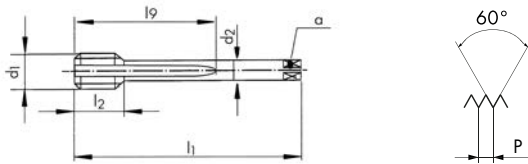

Ø d ₁ M	P mm	l ₁ mm	l ₂ mm	l ₉ mm	d ₂ mm	a mm			ID	ID
6	1	110	17	30	4.5	3.4	3	5	● 170646	● 172699
8	1.25	110	20	40	6	4.9	3	6.8	● 170649	● 172700
10	1.5	125	22	50	7	5.5	3	8.5	● 170652	● 172701
12	1.75	140	24	60	9	7	3	10.2	● 167982	● 172702
14	2	140	28	70	11	9	4	12	● 167983	
16	2	160	30	80	12	9	4	14	● 167984	● 170573
20	2.5	180	36	100	16	12	5	17.5	● 167985	● 170576
24	3	200	39	120	18	14.5	5	21	● 167986	● 172704
27	3	225	42	135	20	16	5	24	● 167987	
30	3.5	250	45	150	22	18	5	26.5	● 165542	
33	3.5	280	48	165	25	20	5	29.5	● 167988	
36	4	300	51	180	28	22	6	32	● 167989	
39	4	300	55	195	32	24	6	35	● 167990	
42	4.5	355	55	210	32	24	6	37.5	● 167999	

Vc (m/min) Guide Line

	M5 - M10	M12 - M16	M20 - M30	M33 - M42
	30 - 40	20 - 30	20 - 30	20 - 30
	30 - 40	30 - 40	30 - 40	30 - 40
	20 - 30	15 - 25	15 - 25	15 - 25
	15 - 20	10 - 15	8 - 12	5 - 8
	8 - 12	5 - 8	5 - 8	5 - 8

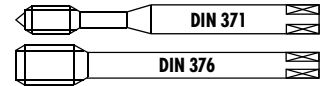

QTAP

Q320VS-4



Q420VS-4



Q323VS-4



Q423VS-4



- 11 12 13 14
- 15 21 22 23
- 24 31 32 51
- 52 61 62 63
- 64 71 72 73
- 74 81 82 83
- 91 92 94

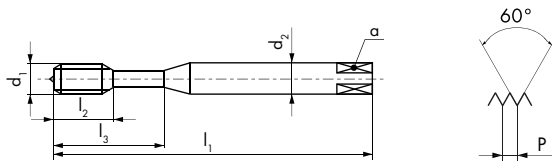

Q320VS-4

Q420VS-4

Q323VS-4

Q423VS-4



NEW



NEW



NEW



NEW



$\emptyset d_1$ M	P mm	l_1 mm	l_2 mm	l_3 mm	d_2 mm	a mm		
3	0.5	56	12	18	3.5	2.7	3	2.5
4	0.7	63	14	21	4.5	3.4	3	3.3
5	0.8	70	15	25	6	4.9	3	4.2
6	1	80	17	30	6	4.9	3	5
8	1.25	90	20	35	8	6.2	3	6.8
10	1.5	100	22	39	10	8	3	8.5
12	1.75	110	24		9	7	3	10.2
14	2	110	28		11	9	3	12
16	2	110	30		12	9	3	14
20	2.5	140	36		16	12	4	17.5
24	3	160	39		18	14.5	4	21

ID	ID	ID	ID
● 195494		● 195505	
● 195495		● 195506	
● 195496		● 195507	
● 195497		● 195508	
● 195498		● 195509	
● 195499		● 195510	
	● 195500		● 195511
	● 195501		● 195512
	● 195502		● 195513
	● 195503		● 195514
	● 195504		● 195515



≤ Ø 16 > Ø 16

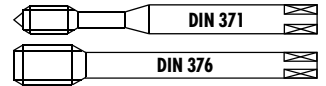
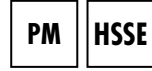

QTAP

Q360VS-3



Q460VS-3



Q363VS-3



Q463VS-3

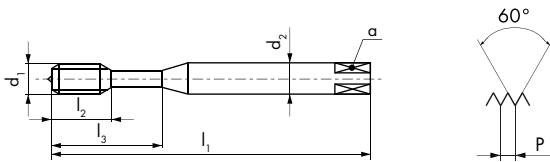

Q360VS-3

Q460VS-3

Q363VS-3

Q463VS-3



NEW



NEW



NEW



NEW



Ø d ₁ M	P mm	l ₁ mm	l ₂ mm	l ₃ mm	d ₂ mm	a mm		
3	0.5	56	5.5	18	3.5	2.7	3	2.5
4	0.7	63	7.5	21	4.5	3.4	3	3.3
5	0.8	70	9	25	6	4.9	3	4.2
6	1	80	11	30	6	4.9	3	5
8	1.25	90	12.5	35	8	6.2	3	6.8
10	1.5	100	14	39	10	8	3	8.5
12	1.75	110	14		9	7	3	10.2
14	2	110	14		11	9	3	12
16	2	110	18		12	9	3	14
20	2.5	140	24		16	12	3	17.5
24	3	160	27		18	14.5	4	21

ID

ID

ID

ID

● 195516

● 195527

● 195517

● 195528

● 195518

● 195529

● 195519

● 195530

● 195520

● 195531

● 195521

● 195532

● 195522

● 195533

● 195523

● 195534

● 195524

● 195535

● 195525

● 195536

● 195526

● 195537



Uniquement pour taraudage synchrone
Nur für Synchrobearbeitung
Only for rigid tapping
Solo per mischilatura sincrona
Solo para roscado sincronizado
Только для rigid tapping

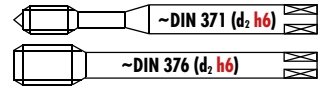

RTS

Rigid Tapping Synchro

RTS320VS-4			<table border="1"> <tr><td>11</td><td>12</td><td>13</td><td>14</td></tr> <tr><td>15</td><td>21</td><td>31</td><td>32</td></tr> <tr><td>51</td><td>61</td><td>63</td><td>64</td></tr> <tr><td>72</td><td>73</td><td>74</td><td>81</td></tr> <tr><td>82</td><td>83</td><td>91</td><td>92</td></tr> <tr><td>94</td><td></td><td></td><td></td></tr> </table>	11	12	13	14	15	21	31	32	51	61	63	64	72	73	74	81	82	83	91	92	94			
11	12	13	14																								
15	21	31	32																								
51	61	63	64																								
72	73	74	81																								
82	83	91	92																								
94																											
RTS420VS-4			<table border="1"> <tr><td>11</td><td>12</td><td>13</td><td>14</td></tr> <tr><td>15</td><td>21</td><td>31</td><td>32</td></tr> <tr><td>51</td><td>61</td><td>63</td><td>64</td></tr> <tr><td>72</td><td>73</td><td>74</td><td>81</td></tr> <tr><td>82</td><td>83</td><td>91</td><td>92</td></tr> <tr><td>94</td><td></td><td></td><td></td></tr> </table>	11	12	13	14	15	21	31	32	51	61	63	64	72	73	74	81	82	83	91	92	94			
11	12	13	14																								
15	21	31	32																								
51	61	63	64																								
72	73	74	81																								
82	83	91	92																								
94																											
RTS323VS-4			<table border="1"> <tr><td>11</td><td>12</td><td>13</td><td>14</td></tr> <tr><td>15</td><td>21</td><td>31</td><td>32</td></tr> <tr><td>51</td><td>61</td><td>63</td><td>64</td></tr> <tr><td>72</td><td>73</td><td>74</td><td>81</td></tr> <tr><td>82</td><td>83</td><td>91</td><td>92</td></tr> <tr><td>94</td><td></td><td></td><td></td></tr> </table>	11	12	13	14	15	21	31	32	51	61	63	64	72	73	74	81	82	83	91	92	94			
11	12	13	14																								
15	21	31	32																								
51	61	63	64																								
72	73	74	81																								
82	83	91	92																								
94																											
RTS423VS-4			<table border="1"> <tr><td>11</td><td>12</td><td>13</td><td>14</td></tr> <tr><td>15</td><td>21</td><td>31</td><td>32</td></tr> <tr><td>51</td><td>61</td><td>63</td><td>64</td></tr> <tr><td>72</td><td>73</td><td>74</td><td>81</td></tr> <tr><td>82</td><td>83</td><td>91</td><td>92</td></tr> <tr><td>94</td><td></td><td></td><td></td></tr> </table>	11	12	13	14	15	21	31	32	51	61	63	64	72	73	74	81	82	83	91	92	94			
11	12	13	14																								
15	21	31	32																								
51	61	63	64																								
72	73	74	81																								
82	83	91	92																								
94																											

RTS320VS-4	RTS420VS-4	RTS323VS-4	RTS423VS-4
------------	------------	------------	------------

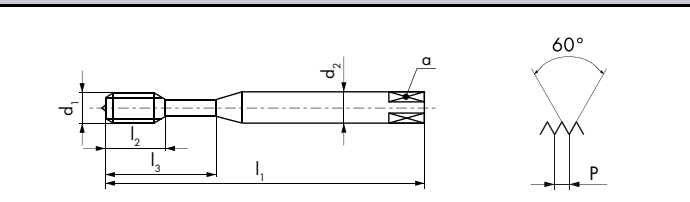
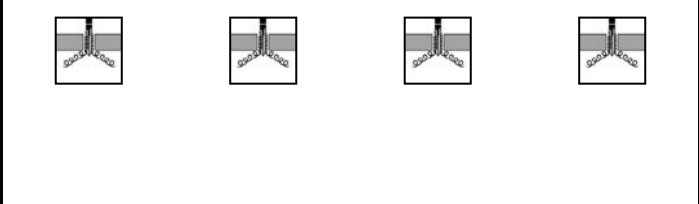

6HX	6HX	6HX	6HX

$\emptyset d_1$ M	P mm	l_1 mm	l_2 mm	l_3 mm	$d_2 h6$ mm	a mm			ID	ID	ID	ID
* 2	0.4	45	8		2.8(h9)	2.1	2	1.6	● 143532			
2.5	0.45	50	10		2.8(h9)	2.1	3	2.05	● 143534			
3	0.5	56	5.5	18	3.5(h9)	2.7	3	2.5	● 150601			
4	0.7	63	7.5	21	4.5(h9)	3.4	3	3.3	● 150603			
5	0.8	70	9	25	6	4.9	3	4.2	● 150605		● 150606	
6	1	80	11	30	6	4.9	3	5	● 150610		● 150611	
8	1.25	90	12.5	35	8	6.2	3	6.8	● 150620		● 150621	
10	1.5	100	14	39	10	8	3	8.5	● 150635		● 150636	
12	1.75	110	14		* 10	* 8	3	10.2		● 151863		● 151864
14	2	110	14		* 12	* 9	3	12		● 162535		
16	2	110	18		12	9	3	14		● 150670		● 150671
20	2.5	140	24		16	12	4	17.5		● 150679		
24	3	160	27		16	12	4	21		● 162787		

* Norme DC / * DC Norm / * Norma DC

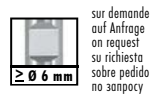
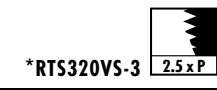



Uniquement pour taraudage synchrone
Nur für Synchrobearbeitung
Only for rigid tapping
Solo per mescolatura sincrona
Solo para roscado sincronizado
Только для rigid tapping

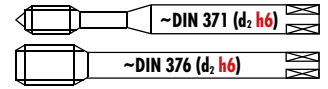

RTS

Rigid Tapping Synchro

RTS362VS-3				<table border="1"> <tr><td>11</td><td>12</td><td>13</td><td>14</td></tr> <tr><td>15</td><td>21</td><td>31</td><td>32</td></tr> <tr><td>51</td><td>61</td><td>63</td><td>64</td></tr> <tr><td>72</td><td>73</td><td>74</td><td>81</td></tr> <tr><td>82</td><td>83</td><td>91</td><td>92</td></tr> <tr><td>94</td><td></td><td></td><td></td></tr> </table>	11	12	13	14	15	21	31	32	51	61	63	64	72	73	74	81	82	83	91	92	94			
11	12	13	14																									
15	21	31	32																									
51	61	63	64																									
72	73	74	81																									
82	83	91	92																									
94																												
RTS462VS-3				<table border="1"> <tr><td>11</td><td>12</td><td>13</td><td>14</td></tr> <tr><td>15</td><td>21</td><td>31</td><td>32</td></tr> <tr><td>51</td><td>61</td><td>63</td><td>64</td></tr> <tr><td>72</td><td>73</td><td>74</td><td>81</td></tr> <tr><td>82</td><td>83</td><td>91</td><td>92</td></tr> <tr><td>94</td><td></td><td></td><td></td></tr> </table>	11	12	13	14	15	21	31	32	51	61	63	64	72	73	74	81	82	83	91	92	94			
11	12	13	14																									
15	21	31	32																									
51	61	63	64																									
72	73	74	81																									
82	83	91	92																									
94																												
RTS365VS-3				<table border="1"> <tr><td>11</td><td>12</td><td>13</td><td>14</td></tr> <tr><td>15</td><td>21</td><td>31</td><td>32</td></tr> <tr><td>51</td><td>61</td><td>63</td><td>64</td></tr> <tr><td>72</td><td>73</td><td>74</td><td>81</td></tr> <tr><td>82</td><td>83</td><td>91</td><td>92</td></tr> <tr><td>94</td><td></td><td></td><td></td></tr> </table>	11	12	13	14	15	21	31	32	51	61	63	64	72	73	74	81	82	83	91	92	94			
11	12	13	14																									
15	21	31	32																									
51	61	63	64																									
72	73	74	81																									
82	83	91	92																									
94																												
RTS465VS-3				<table border="1"> <tr><td>11</td><td>12</td><td>13</td><td>14</td></tr> <tr><td>15</td><td>21</td><td>31</td><td>32</td></tr> <tr><td>51</td><td>61</td><td>63</td><td>64</td></tr> <tr><td>72</td><td>73</td><td>74</td><td>81</td></tr> <tr><td>82</td><td>83</td><td>91</td><td>92</td></tr> <tr><td>94</td><td></td><td></td><td></td></tr> </table>	11	12	13	14	15	21	31	32	51	61	63	64	72	73	74	81	82	83	91	92	94			
11	12	13	14																									
15	21	31	32																									
51	61	63	64																									
72	73	74	81																									
82	83	91	92																									
94																												

RTS362VS-3	RTS462VS-3	RTS365VS-3	RTS465VS-3
------------	------------	------------	------------

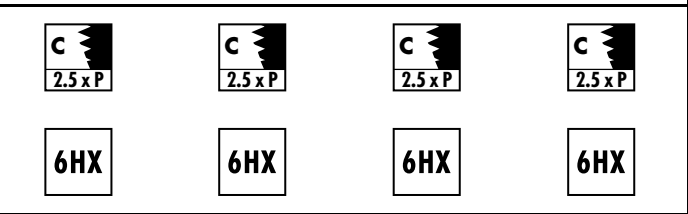
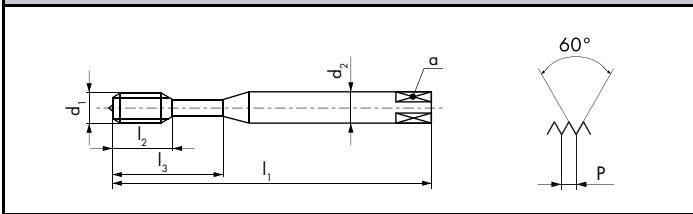
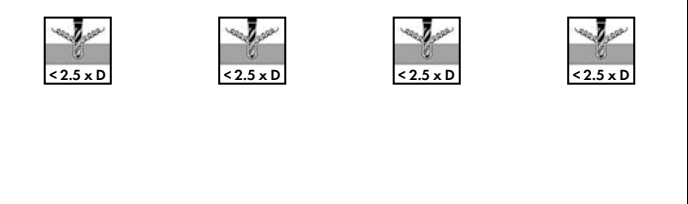

Ø d ₁ M	P mm	l ₁ mm	l ₂ mm	l ₃ mm	d ₂ h6 mm	a mm			ID	ID	ID	ID
* 2	0.4	45	7		2.8(h9)	2.1	3	1.6	● 143536			
* 2.5	0.45	50	9		2.8(h9)	2.1	3	2.05	● 143538			
3	0.5	56	5.5	18	3.5(h9)	2.7	3	2.5	● 150602		● 160477	
4	0.7	63	7.5	21	4.5(h9)	3.4	3	3.3	● 150604		● 160478	
5	0.8	70	9	25	6	4.9	3	4.2	● 150607		● 150608	
6	1	80	11	30	6	4.9	3	5	● 150612		● 150613	
8	1.25	90	12.5	35	8	6.2	3	6.8	● 150622		● 150623	
10	1.5	100	14	39	10	8	3	8.5	● 150637		● 150638	
12	1.75	110	14		* 10	* 8	3	10.2		● 151865		● 151866
14	2	110	14		* 12	* 9	3	12		● 151870		● 150663
16	2	110	18		12	9	3	14		● 150672		● 150673
20	2.5	140	24		16	12	4	17.5		● 150681		● 150682
24	3	160	27		16	12	4	21		● 151873		● 150690

* Norme DC / * DC Norm / * Norma DC

*RTS360VS-3

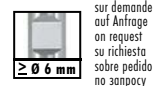



Uniquement pour taraudage synchrone
 Nur für Synchronbearbeitung
 Only for rigid tapping
 Solo per miscelatura sincrona
 Solo para roscado sincronizado
 Только для rigid tapping

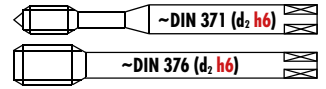

RTS

Rigid Tapping Synchro

RTS362VS-3



RTS462VS-3

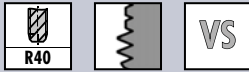

RTS362VS-3

RTS462VS-3

RTS362VS-3

RTS462VS-3



NEW

NEW

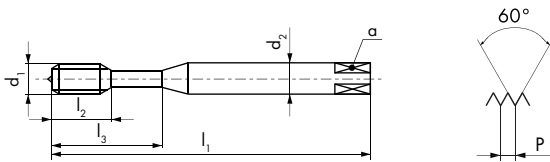

Ø d ₁ M	P mm	l ₁ mm	l ₂ mm	l ₃ mm	d ₂ h6 mm	a mm		
3	0.5	56	5.5	18	3.5(h9)	2.7	3	2.5
4	0.7	63	7.5	21	4.5(h9)	3.4	3	3.35
5	0.8	70	9	25	6	4.9	3	4.25
6	1	80	11	30	6	4.9	3	5
8	1.25	90	12.5	35	8	6.2	3	6.8
10	1.5	100	14	39	10	8	3	8.5
12	1.75	110	14		* 10	* 8	3	10.3
16	2	110	18		12	9	3	14

* Norme DC / * DC Norm / * Norma DC

ID	6H + mm	ID	6H + mm	ID	6H + mm	ID	6H + mm
● 162797	0.020			● 184689	0.036		
● 162798	0.022			● 184691	0.041		
● 162799	0.024			● 184693	0.044		
● 162800	0.026			● 184695	0.050		
● 162801	0.028			● 184697	0.052		
● 162802	0.032			● 184699	0.060		
		● 163253	0.034			● 184701	0.066
		● 172037	0.038			● 184703	0.072



sur demande
 auf Anfrage
 on request
 su richiesta
 sobre pedido
 no zapyty



Uniquement pour taraudage synchrone
 Nur für Synchronbearbeitung
 Only for rigid tapping
 Solo per mescolatura sincrona
 Solo para resacado sincronizado
 Только для rigid tapping

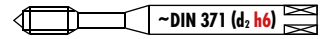

RTS

Rigid Tapping Synchro

RTS362VS-5

R40 VS

RTS365VS-5

R40 VS

11	12	13	14
15	21	31	32
51	61	63	64
72	73	74	81
82	83	91	92
94			

RTS362VS-5	RTS365VS-5		
------------	------------	--	--

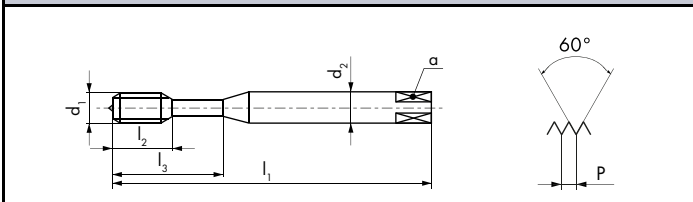
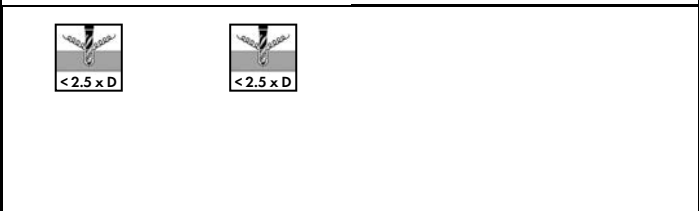

E 1.5 x P	E 1.5 x P
6HX	6HX

Ø d ₁ M	P mm	l ₁ mm	l ₂ mm	l ₃ mm	d ₂ h6 mm	a mm			ID	ID
3	0.5	56	5.5	18	3.5(h9)	2.7	3	2.5	● 157648	
4	0.7	63	7.5	21	4.5(h9)	3.4	3	3.3	● 157650	
5	0.8	70	9	25	6	4.9	3	4.2	● 157652	● 162791
6	1	80	11	30	6	4.9	3	5	● 158074	● 151803
8	1.25	90	12.5	35	8	6.2	3	6.8	● 158076	● 157821
10	1.5	100	14	39	10	8	3	8.5	● 153286	● 157823

sur demande
 auf Anfrage
 on request
 su richiesta
 sobre pedido
 no зпитры

≥ Ø 6 mm



Uniquement pour taraudage synchro
Nur für Synchrobearbeitung
Only for rigid tapping
Solo per mischilatura sincrona
Solo para roscado sincronizado
Только для rigid tapping

PM

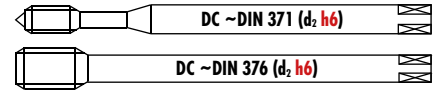

RTS

Rigid Tapping Synchro

RTS523VS-4				<table border="1"> <tr><td>11</td><td>12</td><td>13</td><td>14</td></tr> <tr><td>15</td><td>21</td><td>31</td><td>32</td></tr> <tr><td>51</td><td>61</td><td>63</td><td>64</td></tr> <tr><td>72</td><td>73</td><td>74</td><td>81</td></tr> <tr><td>82</td><td>83</td><td>91</td><td>92</td></tr> <tr><td>94</td><td></td><td></td><td></td></tr> </table>	11	12	13	14	15	21	31	32	51	61	63	64	72	73	74	81	82	83	91	92	94			
11	12	13	14																									
15	21	31	32																									
51	61	63	64																									
72	73	74	81																									
82	83	91	92																									
94																												
RTS623VS-4				<table border="1"> <tr><td>11</td><td>12</td><td>13</td><td>14</td></tr> <tr><td>15</td><td>21</td><td>31</td><td>32</td></tr> <tr><td>51</td><td>61</td><td>63</td><td>64</td></tr> <tr><td>72</td><td>73</td><td>74</td><td>81</td></tr> <tr><td>82</td><td>83</td><td>91</td><td>92</td></tr> <tr><td>94</td><td></td><td></td><td></td></tr> </table>	11	12	13	14	15	21	31	32	51	61	63	64	72	73	74	81	82	83	91	92	94			
11	12	13	14																									
15	21	31	32																									
51	61	63	64																									
72	73	74	81																									
82	83	91	92																									
94																												
RTS565VS-3				<table border="1"> <tr><td>11</td><td>12</td><td>13</td><td>14</td></tr> <tr><td>15</td><td>21</td><td>31</td><td>32</td></tr> <tr><td>51</td><td>61</td><td>63</td><td>64</td></tr> <tr><td>72</td><td>73</td><td>74</td><td>81</td></tr> <tr><td>82</td><td>83</td><td>91</td><td>92</td></tr> <tr><td>94</td><td></td><td></td><td></td></tr> </table>	11	12	13	14	15	21	31	32	51	61	63	64	72	73	74	81	82	83	91	92	94			
11	12	13	14																									
15	21	31	32																									
51	61	63	64																									
72	73	74	81																									
82	83	91	92																									
94																												
RTS665VS-3				<table border="1"> <tr><td>11</td><td>12</td><td>13</td><td>14</td></tr> <tr><td>15</td><td>21</td><td>31</td><td>32</td></tr> <tr><td>51</td><td>61</td><td>63</td><td>64</td></tr> <tr><td>72</td><td>73</td><td>74</td><td>81</td></tr> <tr><td>82</td><td>83</td><td>91</td><td>92</td></tr> <tr><td>94</td><td></td><td></td><td></td></tr> </table>	11	12	13	14	15	21	31	32	51	61	63	64	72	73	74	81	82	83	91	92	94			
11	12	13	14																									
15	21	31	32																									
51	61	63	64																									
72	73	74	81																									
82	83	91	92																									
94																												

RTS523VS-4	RTS623VS-4	RTS565VS-3	RTS665VS-3
------------	------------	------------	------------

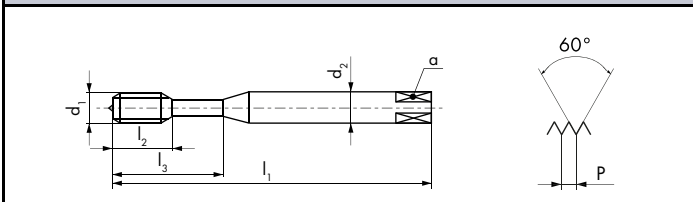

6HX	6HX	6HX	6HX

Ø d1 M	P mm	l1 mm	l2 mm	l3 mm	d2 h6 mm	a mm		
5	0.8	125	9	25	6	4.9	3	4.2
6	1	125	11	30	6	4.9	3	5
8	1.25	140	12.5	35	8	6.2	3	6.8
10	1.5	160	14	39	10	8	3	8.5
12	1.75	180	14		* 10	* 8	3	10.2
16	2	200	18		12	9	3	14

ID	ID
● 161038	
● 161041	
● 161044	
● 161047	
	● 161050
	● 161053

* Norme DC / * DC Norm/ * Norma DC

Ø d1 M	P mm	l1 mm	l2 mm	l3 mm	d2 h6 mm	a mm		
6	1	125	11	30	6	4.9	3	5
8	1.25	140	12.5	35	8	6.2	3	6.8
10	1.5	160	14	39	10	8	3	8.5
12	1.75	180	14		* 10	* 8	3	10.2
16	2	200	18		12	9	3	14

ID	ID
	● 150614
	● 150624
	● 150639
	● 151867
	● 150674

* Norme DC / * DC Norm/ * Norma DC



sur demande
auf Anfrage
on request
su richiesta
sobre pedido
no zapyty



TARAUDS À REFOULER

Dans ce catalogue, vous trouverez le programme des tarauds à refouler FS - FPS - FAS dans un chapitre séparé qui commence à la **page 244.**

MASCHI A RULLARE

In questo catalogo troverete il programma di maschi a rullare FS - FPS - FAS in un capitolo separato a partire da **pagina 244.**

										N1110-1	N1110-2	N1110-3	N1110-S
<p>N1110-1</p>													
<p>N1110-2</p>													
<p>N1110-3</p> <p>31 62 73 74 91</p>													
<p>N1110-S</p>													
Ø d ₁ M	P mm	l ₁ mm	l ₂ mm	l ₃ mm	d ₂ mm	a mm			ID	ID	ID	ID	
1	0.25	40	5.5		2.5	2.1	3	0.75	● 102744	● 102844	● 102917	● 111015	
1.2	0.25	40	5.5		2.5	2.1	3	0.95	● 102746	● 102846	● 102919	● 111017	
1.4	0.3	40	7		2.5	2.1	3	1.1	● 102747	● 102847	● 102920	● 111018	
1.6	0.35	40	8		2.5	2.1	3	1.25	● 102749	● 102849	● 102922	● 111020	
1.7	0.35	40	8		2.5	2.1	3	1.35	● 102750	● 102850	● 102923	● 111021	
1.8	0.35	40	8		2.5	2.1	3	1.45	● 102751	● 102851	● 102924	● 111022	
2	0.4	45	8		2.8	2.1	3	1.6	● 102759	● 102854	● 102934	● 111028	
2.2	0.45	45	9.5		2.8	2.1	3	1.75	● 102761	● 102856	● 102937	● 111030	
2.5	0.45	45	9.5		2.8	2.1	3	2.05	● 102763	● 102858	● 102941	● 111032	
2.6	0.45	45	9.5		2.8	2.1	3	2.15	● 102765	● 102860	● 102944	● 111034	
3	0.5	48	11	18	3.15	2.5	3	2.5	● 102766	● 102861	● 102947	● 111036	
3.5	0.6	50	13	20	3.55	2.8	3	2.9	● 102769	● 102864	● 102950	● 111038	
4	0.7	53	13	21	4	3.15	3	3.3	● 102771	● 102866	● 102956	● 111042	
4.5	0.75	53	13	21	4.5	3.55	3	3.75	* 102775	* 102869	* 102959	* 111044	
5	0.8	58	16	25	5	4	3	4.2	● 102776	● 102870	● 102965	● 111047	
6	1	66	19	30	6.3	5	3	5	● 102781	● 102874	● 102973	● 111053	
7	1	66	19	30	7.1	5.6	3	6	* 102786	* 102876	* 102978	* 111055	
8	1.25	72	22	35	8	6.3	3	6.8	● 102788	● 102878	● 102986	● 111059	
9	1.25	72	22	36	9	7.1	3	7.8	* 102792	* 102880	* 102991	* 111061	
10	1.5	80	24	39	10	8	3	8.5	● 102752	● 102852	● 102931	● 111026	

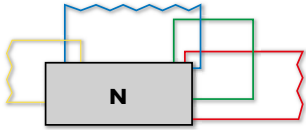

N1210-1	
N1210-2	
N1210-3	31 62 73 74 91
N1210-S	

N1210-1	N1210-2	N1210-3	N1210-S

		$< 1.5 \times D$	$< 2.5 \times D$
--	--	------------------	------------------

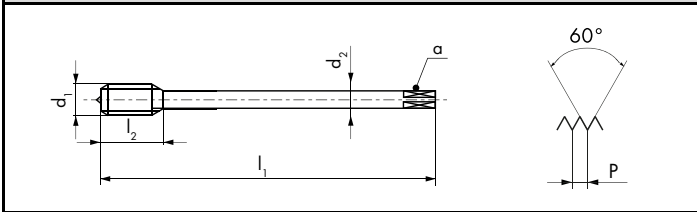







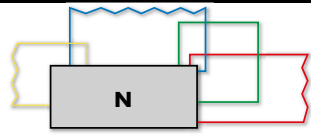





		ISO 2 6H	ISO 2 6H

$\emptyset d_1$ M	P mm	l_1 mm	l_2 mm	d_2 mm	a mm			ID	ID	ID	ID
11	1.5	85	22	8	6.3	3	9.5	* 103302	* 103427	● 103489	* 111168
12	1.75	89	24	9	7.1	3	10.2	● 103303	● 103428	● 103499	● 111173
14	2	95	24	11.2	9	3	12	● 103310	● 103430	● 103510	● 111179
16	2	102	32	12.5	10	3	14	● 103319	● 103432	● 103522	● 111185
18	2.5	112	30	14	11.2	3	15.5	● 103324	● 103434	● 103534	● 111191
20	2.5	112	37	14	11.2	3	17.5	● 103330	● 103436	● 103543	● 111196
22	2.5	115	32	16	12.5	3	19.5	* 103337	* 103438	* 103550	* 125567
24	3	130	45	18	14	4	21	● 103341	● 103440	● 103557	● 111204
27	3	135	45	20	16	4	24	* 103347	* 103442	* 103568	* 111211
30	3.5	138	48	20	16	4	26.5	● 103353	● 103444	● 103579	● 111216
33	3.5	151	51	22.4	18	4	29.5	* 103357	* 103446	* 103581	* 111218
36	4	162	57	25	20	4	32	* 103359	* 103448	* 103583	* 111220



										NP110-1	NP110-2	NP110-3	NP110-S
NP110-1													
NP110-2													
NP110-3 													
NP110-S													
$\emptyset d_1$ M	P mm	l_1 mm	l_2 mm	l_3 mm	d_2 mm	a mm				ID	ID	ID	ID
3	0.5	40	11	18	3.5	2.7	3			● 174678	● 174687	● 174696	● 173676
4	0.7	45	13	21	4.5	3.4	3			● 174679	● 174688	● 174697	● 173644
5	0.8	50	16	24	6	4.9	3			● 174680	● 174689	● 174698	● 173677
6	1	56	19	27	6	4.9	3			● 174681	● 174690	● 174699	● 173394



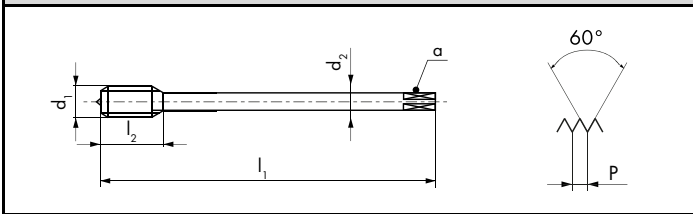

NP210-1	
NP210-2	
NP210-3	 31 62 73 74 91
NP210-S	

NP210-1	NP210-2	NP210-3	NP210-S
			
NEW	NEW	NEW	NEW
		 < 1.5 x D	 < 2.5 x D



 3 x P	 3 x P	 C 3 x P	
		ISO 2 6H	ISO 2 6H

$\varnothing d_1$ M	P mm	l_1 mm	l_2 mm	d_2 mm	a mm			ID	ID	ID	ID
8	1.25	63	22	6	4.9	3	6.8	● 174682	● 174691	● 174700	● 173645
10	1.5	70	24	7	5.5	3	8.5	● 174683	● 174692	● 174701	● 173646
12	1.75	75	28	9	7	3	10.2	● 174684	● 174693	● 174702	● 173647
14	2	80	30	11	9	3	12	● 174685	● 174694	● 174703	● 173648
16	2	80	32	12	9	3	14	● 180705	● 180706	● 180707	● 174677

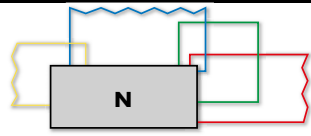
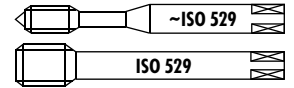

N1120-4	N1220-4	N1160-3	N1260-3
---------	---------	---------	---------

N1120-4		62 63 64 72 73 74 81 91
N1220-4		62 63 64 72 73 74 81 91
N1160-3		63 72 73 74 81 91
N1260-3		63 72 73 74 81 91



--	--	--	--

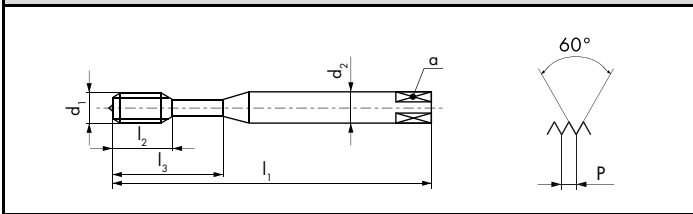

ISO 2 6H	ISO 2 6H	ISO 2 6H	ISO 2 6H

$\emptyset d_1$ M	P mm	l_1 mm	l_2 mm	l_3 mm	d_2 mm	a mm		
3	0.5	48	11	18	3.15	2.5	3	2.5
4	0.7	53	13	21	4	3.15	3	3.3
5	0.8	58	16	25	5	4	3	4.2
6	1	66	19	30	6.3	5	3	5
8	1.25	72	22	35	8	6.3	3	6.8
10	1.5	80	24	39	10	8	3	8.5
12	1.75	89	24		9	7.1	3	10.2
14	2	95	24		11.2	9	3	12
16	2	102	32		12.5	10	3	14

ID	ID
● 103068	
● 103075	
● 103082	
● 103090	
● 103102	
● 103060	
	● 103670
	● 103680
	● 103690







$\emptyset d_1$ M	P mm	l_1 mm	l_2 mm	l_3 mm	d_2 mm	a mm		
3	0.5	48	5.5	18	3.15	2.5	3	2.5
4	0.7	53	7.5	21	4	3.15	3	3.3
5	0.8	58	9	25	5	4	3	4.2
6	1	66	11	30	6.3	5	3	5
8	1.25	72	12.5	35	8	6.3	3	6.8
10	1.5	80	14	39	10	8	3	8.5
12	1.75	89	14		9	7.1	3	10.2
16	2	102	18		12.5	10	3	14









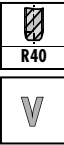
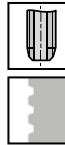

ID	ID
	* 103177
	* 103178
	* 103179
	* 103180
	* 103181
	* 103174
	* 103781
	* 103782































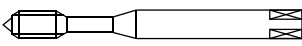
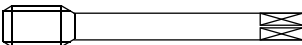



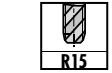















K | DEVELOPING THREADING











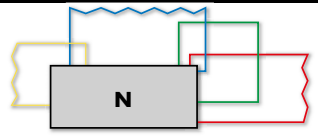









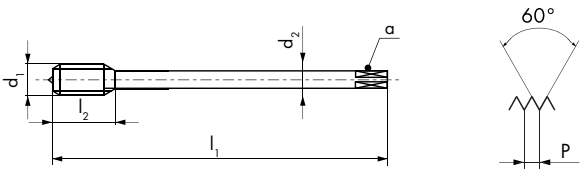

	N							
Caractéristiques Caratteristiche				 V	 TiN	 R15	 R40	
								
Genre de trou Tipo di foro								
		N320-3				N350-3	N360-3	
<i>DIN longue</i> <i>DIN lungo</i> DIN 371		124				124	131	
<i>ISO courte</i> <i>ISO corto</i> ISO 529								
<i>Tolérance</i> <i>Tolleranza</i> ISO 2 6H		124				124	131	
<i>Surcote</i> <i>Maggiorazione</i> ISO 3 6G							131	
<i>Tolérance fine</i> <i>Tolleranza fine</i> ISO 1 4H								
<i>LH Filetage à gauche</i> <i>LH Filettatura sinistra</i> ISO 2 6H								
		N410-3	N420-3	N420-4	N420V-4	N420TN-4	N450-3	N460-3
<i>DIN longue</i> <i>DIN lungo</i> DIN 374/~DIN 376	125 - 130		125 - 130	125 - 128	125 - 127	124	132 - 133	
<i>ISO courte</i> <i>ISO corto</i> ISO 529								
<i>Tolérance</i> <i>Tolleranza</i> ISO 2 6H	125 - 129		125 - 129	125 - 128	125 - 127	124	132 - 133	
<i>Surcote</i> <i>Maggiorazione</i> ISO 3 6G							132	
<i>Tolérance fine</i> <i>Tolleranza fine</i> ISO 1 4H								
<i>Tolérance</i> <i>Tolleranza</i> 7H (EN 60423)		128 - 129						
<i>LH Filetage à gauche</i> <i>LH Filettatura sinistra</i> ISO 2 6H	130		130					

N					Z			
								
								
								
N360V-3	N360TN-3	N1110-1	N1110-3	N1110-S	Z320V-3 Z320V-4	Z320VS-4	Z360V-3	Z370VS-3
131	131				134	134	134	134
		146	146	146				
131	131	146	146	146	134	134	134	134
N460V-3	N460TN-3	N1210-1	N1210-3	N1210-S	Z420V-4	Z420VS-4	Z460V-3	Z470VS-3
132 - 133	132				135	135	135	135
		147 - 148	147 - 148	147 - 148				
132 - 133	132	147 - 148	147 - 148	147 - 148	135	135	135	135











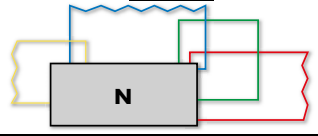

















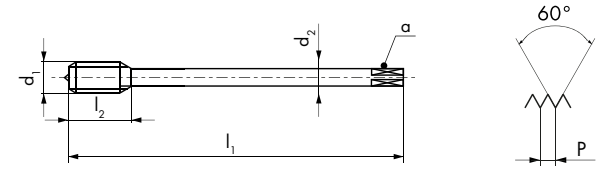

		H		S		SA		
Caractéristiques Caratteristiche		 TiCN	 R25 TiCN	 VS	 R35 VS		 R15	 R10
		 NEW	 NEW					
Genre de trou Tipo di foro								
		H320-4 H320TC-4	H350-3 H350TC-3	S320VS-4	S360VS-3	SA320-4	SA350-3	SA390-3
<i>DIN longue</i> <i>DIN lungo</i>	DIN 371	136	137	138	138	140	140	139
<i>ISO courte</i> <i>ISO corto</i>	ISO 529							
<i>Tolérance</i> <i>Tolleranza</i>	ISO 2 6H	136	137	138	138	140	140	139
<i>Surcote</i> <i>Maggiorazione</i>	ISO 3 6G							
<i>Tolérance fine</i> <i>Tolleranza fine</i>	ISO 1 4H					140	140	
<i>LH Filetage à gauche</i> <i>LH Filettatura sinistra</i>	ISO 2 6H							
		H420-4 H420TC-4	H450-3 H450TC-3	S420VS-4	S460VS-3	SA420-4	SA450-3	
<i>DIN longue</i> <i>DIN lungo</i>	DIN 374/~DIN 376	136	137	138	138	141	141	
<i>ISO courte</i> <i>ISO corto</i>	ISO 529							
<i>Tolérance</i> <i>Tolleranza</i>	ISO 2 6H	136	137	138	138	141	141	
<i>Surcote</i> <i>Maggiorazione</i>	ISO 3 6G							
<i>Tolérance fine</i> <i>Tolleranza fine</i>	ISO 1 4H					141	141	
<i>Tolérance</i> <i>Tolleranza</i>	7H (EN 60423)							
<i>LH Filetage à gauche</i> <i>LH Filettatura sinistra</i>	ISO 2 6H							

TL		K	QTAP				RTS	
 VS	 R15 VS	 TiCN	 VS	 VS	 R40 VS	 R40 VS	 VS	 R40 VS
			 NEW	 NEW	 NEW	 NEW		
								
TL320VS-4	TL351VS-3	K313TC-3	Q320VS-4	Q323VS-4	Q360VS-3	Q363VS-3	RTS320VS-4	RTS362VS-3
140	140	142	143	143	144	144	145	145
140	140	142	143	143	144	144	145	145
140	140							
TL420VS-4	TL451VS-3	K413TC-3	Q420VS-4	Q423VS-4	Q460VS-3	Q463VS-3	RTS420VS-4	RTS462VS-3
141	141	142	143	143	144	144	145	145
141	141	142	143	143	144	144	145	145
141	141							











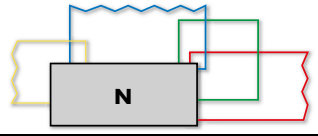





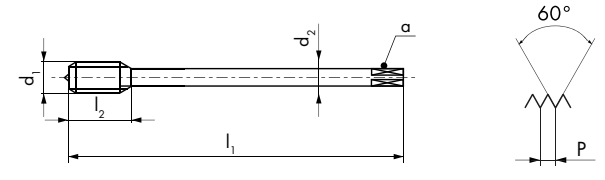

								N410-3	N420-4	N420V-4	N420TN-4
								 31 62 73 74 91			
 62 63 64 72 73 74 81 91											
  11 12 31 32											
  11 12 13 14 32											
								 	 	 	 
Ø d ₁ MF	P mm	l ₁ mm	l ₂ mm	d ₂ mm	a mm			ID	ID	ID	ID
* 4	0.35	63	14	2.8	2.1	3	3.65		● 142695		
4	0.5	63	14	2.8	2.1	3	3.5	● 101923	● 102145	● 142715	
4.5	0.5	70	15	3.5	2.7	3	4		● 102150		
5	0.5	70	15	3.5	2.7	3	4.5	● 101941	● 102167	● 142716	
5	0.75	70	15	3.5	2.7	3	4.25		● 102168		
5.5	0.5	80	17	4	3	3	5		● 142696		
6	0.5	80	17	4.5	3.4	3	5.5	● 101951	● 102178	● 142717	
6	0.75	80	17	4.5	3.4	3	5.25	● 101952	● 102179	● 102281	● 102249
7	0.5	80	17	5.5	4.3	3	6.5		● 102187		
7	0.75	80	17	5.5	4.3	3	6.25	● 101954	● 102188		
8	0.5	90	20	6	4.9	3	7.5	● 101955	● 102190	● 142718	
8	0.75	90	20	6	4.9	3	7.25	● 101956	● 102191	● 102283	
8	1	90	20	6	4.9	3	7	● 101957	● 102192	● 102284	● 102250
9	0.5	90	20	7	5.5	3	8.5		● 142697		
9	0.75	90	20	7	5.5	3	8.25		● 102200		
9	1	90	20	7	5.5	3	8		● 102201	● 143935	
10	0.5	100	22	7	5.5	3	9.5		● 142698		
10	0.75	100	22	7	5.5	3	9.25	● 101863	● 102056		
10	1	100	22	7	5.5	3	9	● 101864	● 102057	● 102262	● 102239
10	1.25	100	22	7	5.5	3	8.8	● 101865	● 102058	● 142719	● 148108











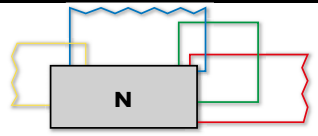



















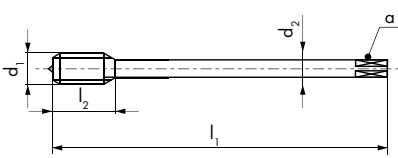

*N420-3



									N410-3	N420-4	N420V-4	N420TN-4
N410-3		31 62 73 74 91										
N420-4		62 63 64 72 73 74 81 91										
N420V-4	 V	11 12 31 32										
N420TN-4	 TiN	11 12 13 14 32										
												
												
Ø d ₁ MF	P mm	l ₁ mm	l ₂ mm	d ₂ mm	a mm			ID	ID	ID	ID	
11	0.5	100	19	8	6.2	3	10.5		● 142699			
11	0.75	100	19	8	6.2	3	10.25		● 142700			
11	1	100	19	8	6.2	3	10		● 142701			
11	1.25	100	19	8	6.2	3	9.8		● 142702			
12	0.5	100	14	9	7	3	11.5		● 102066			
12	0.75	100	24	9	7	3	11.25		● 142703			
12	1	100	24	9	7	3	11	● 101867	● 102067	● 142345	● 102241	
12	1.25	100	24	9	7	3	10.8	● 101868	● 102068	● 142721		
12	1.5	100	24	9	7	3	10.5	● 101869	● 102069	● 102264	● 102242	
13	1	100	21	11	9	3	12	● 158401	● 142704			
14	0.5	100	14	11	9	3	13.5		● 142705			
14	0.75	100	24	11	9	3	13.25		● 142706			
14	1	100	24	11	9	3	13	● 101871	● 102077			
14	1.25	100	24	11	9	3	12.8	● 101872	● 102078			
14	1.5	100	24	11	9	3	12.5	● 101873	● 102079	● 102266	● 102244	
15	1	100	26	12	9	3	14	● 101875	● 102085			
15	1.5	100	26	12	9	3	13.5	● 101876	● 102086			
16	0.75	100	26	12	9	3	15.25		● 142708			
16	1	100	26	12	9	*3	15	● 101877	● 102087			
16	1.25	100	26	12	9	*3	14.8	● 101878	● 102088			
16	1.5	100	26	12	9	*3	14.5	● 101879	● 102089	● 102268	● 102246	
17	1	100	26	12	9	3	16		● 142709			
17	1.5	100	26	12	9	3	15.5		● 142710			
18	0.75	110	26	14	11	4	17.25		● 142711			
18	1	110	26	14	11	4	17	● 101881	● 102095			
18	1.5	110	26	14	11	4	16.5	● 101882	● 102096	● 102270	● 145350	
18	2	125	33	14	11	3	16		● 142712			

* N410-3 =  4

								N410-3	N420-4	N420V-4	N420TN-4
								 31 62 73 74 91			
 62 63 64 72 73 74 81 91											
 V 11 12 31 32											
 TiN 11 12 13 14 32											
								 	 	 	 
Ø d ₁ MF	P mm	l ₁ mm	l ₂ mm	d ₂ mm	a mm			ID	ID	ID	ID
20	1	125	28	16	12	4	19		● 102098		
20	1.5	125	28	16	12	4	18.5	● 101884	● 102099	● 102272	● 143932
20	2	140	36	16	12	3	18	● 105130	● 102100		
22	1	125	28	18	14.5	4	21		● 102104		
22	1.5	125	28	18	14.5	4	20.5	● 101886	● 102105	● 102274	
22	2	140	36	18	14.5	3	20	● 101887	● 142714		
24	1	140	30	18	14.5	4	23		● 102107		
24	1.5	140	30	18	14.5	4	22.5	● 101889	● 102108	● 102276	
24	2	140	34	18	14.5	4	22	● 101890	● 102109	● 102277	
25	1	140	30	18	14.5	4	24		● 142722		
25	1.5	140	30	18	14.5	4	23.5	● 101892	● 102112		
25	2	140	34	18	14.5	4	23		● 142723		
26	1	140	30	18	14.5	4	25		● 102113		
26	1.5	140	30	18	14.5	4	24.5	● 101893	● 102114	● 145896	
27	1.5	140	34	20	16	4	25.5		● 102115		
27	2	140	34	20	16	4	25	● 101894	● 102116		
28	1	140	30	20	16	4	27		● 142725		
28	1.5	140	30	20	16	4	26.5	● 101896	● 102118		
28	2	140	30	20	16	4	26	● 122023			

								N410-3	N420-4	N420V-4	N420-3
								N410-3  31 62 73 74 91			
N420-4  62 63 64 72 73 74 81 91											
N420V-4   11 12 31 32											
N420-3  62 63 64 72 73 74 81 91											
 	 C 2.5 x P	 B 4 x P	 B 4 x P	 C 2.5 x P							
	 ISO 2 6H	 ISO 2 6H	 ISO 2 6H	 ISO 3 7H							
$\emptyset d_1$ MF	P mm	l_1 mm	l_2 mm	d_2 mm	a mm			ID	ID	ID	ID
30	1	150	32	22	18	4	29	● 101898	● 102121		
30	1.5	150	32	22	18	4	28.5	● 101899	● 102122	● 143978	
30	2	150	32	22	18	4	28	● 101900	● 102123	● 143766	
32	1	150	32	22	18	4	31	● 101902			
32	1.5	150	32	22	18	4	30.5	● 101903	● 102126		● 143812
32	2	150	32	22	18	4	30	● 101904	● 102127		
33	1.5	160	32	25	20	4	31.5	● 101905	● 102128		
33	2	160	32	25	20	4	31	● 101906	● 102129		
34	1.5	170	32	28	22	4	32.5	● 101909			
35	1.5	170	32	28	22	4	33.5	● 101910	● 102132		
35	2	170	32	28	22	4	33	● 101911			
36	1.5	170	34	28	22	4	34.5	● 101912	● 102134		
36	2	170	34	28	22	4	34	● 101913	● 102135		
36	3	200	45	28	22	4	33	● 101914	● 102136		
38	1.5	170	34	28	22	4	36.5	● 101917	● 102139		
38	2	170	34	28	22	4	36	● 101918			
39	2	170	34	32	24	4	37	● 101920			
39	3	200	45	32	24	4	36	● 101921			

MF ISO DIN 13

HSSE



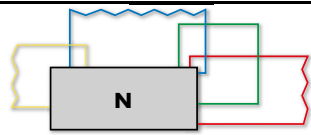

								N410-3	N420-4	N420-3
N410-3		31 62 73 74 91								
N420-4		62 63 64 72 73 74 81 91								
N420-3		62 63 64 72 73 74 81 91								
$\emptyset d_1$ MF	P mm	l_1 mm	l_2 mm	d_2 mm	a mm			ID	ID	ID
40	1	170	34	32	24	5	39	● 101925		
40	1.5	170	34	32	24	5	38.5	● 101926	● 102152	● 143813
40	2	170	34	32	24	5	38	● 101927	● 102153	
40	3	200	45	32	24	4	37	★ 101928		
42	1.5	170	34	32	24	5	40.5	● 101929	● 102155	
42	2	170	34	32	24	5	40	● 101930	● 102156	
42	3	200	45	32	24	4	39	● 101931	● 102157	
45	1.5	180	34	36	29	5	43.5	● 101933	● 102159	
45	2	180	34	36	29	5	43	● 101934		
45	3	200	45	36	29	4	42	● 101935		
48	1.5	190	36	36	29	5	46.5	● 101937	● 102163	
48	2	190	36	36	29	5	46	● 101938	● 102164	
48	3	220	48	36	29	5	45	● 101939	● 102165	
50	1.5	190	36	36	29	5	48.5	● 101943	● 102176	● 143814
50	2	190	36	36	29	5	48	● 101944	★ 102177	
52	2	190	36	40	32	5	50	● 101947		
60	2	220	42	45	35	5	58	● 105132		
63	1.5	220	38	45	35	5	61.5			● 143815



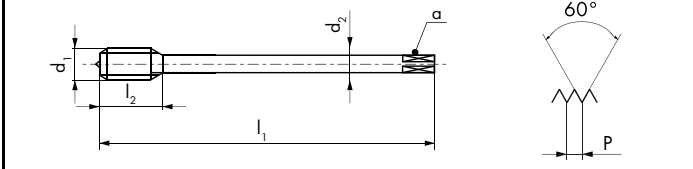

N410-3 LH  **LH** 31 62 73 74 91

N420-4 LH  **LH** 62 63 64 72 73 74
81 91



Ø d ₁ MF	P mm	l ₁ mm	l ₂ mm	d ₂ mm	a mm			ID	ID
4	0.5	63	14	2.8	2.1	3	3.5	● 104844	
5	0.5	70	15	3.5	2.7	3	4.5	● 104845	
6	0.5	80	17	4.5	3.4	3	5.5	● 104846	● 104870
6	0.75	80	17	4.5	3.4	3	5.25	● 104847	● 105133
7	0.75	80	17	5.5	4.3	3	6.25	● 104848	
8	0.5	90	20	6	4.9	3	7.5	● 104849	
8	0.75	90	20	6	4.9	3	7.25	● 104850	● 104871
8	1	90	20	6	4.9	3	7	● 104851	● 104872
10	0.75	100	22	7	5.5	3	9.25	● 104852	
10	1	100	22	7	5.5	3	9	● 104853	● 104873
10	1.25	100	22	7	5.5	3	8.8		● 104874
12	1	100	24	9	7	3	11	● 104854	● 104875
12	1.25	100	24	9	7	3	10.8	● 104855	● 104876
12	1.5	100	24	9	7	3	10.5	● 104856	● 104877
14	1	100	24	11	9	3	13	● 104857	● 104878
14	1.25	100	24	11	9	3	12.8	● 104858	
14	1.5	100	24	11	9	3	12.5	● 104859	● 104879
16	1	100	26	12	9	*3	15	● 104860	● 104880
16	1.5	100	26	12	9	*3	14.5	● 104861	● 104881
18	1	110	26	14	11	4	17	● 104862	
18	1.5	110	26	14	11	4	16.5	● 104863	● 104882
20	1	125	28	16	12	4	19	● 104864	
20	1.5	125	28	16	12	4	18.5	● 104865	● 104883
22	1.5	125	28	18	14.5	4	20.5	● 104866	● 104884
24	1.5	140	30	18	14.5	4	22.5	● 104867	● 104885
24	2	140	34	18	14.5	4	22	● 104868	● 104886
28	1.5	140	30	20	16	4	26.5	● 105166	
30	1.5	150	32	22	18	4	28.5	● 105167	● 105165
30	2	150	32	22	18	4	28	● 105168	

* N410-3 LH =  4

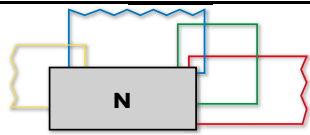

N360-3



63 72 73 74 81 91

N360V-3



11 12 32

N360TN-3



11 12 13 14 32

N360-3

N360V-3

N360TN-3

N360-3

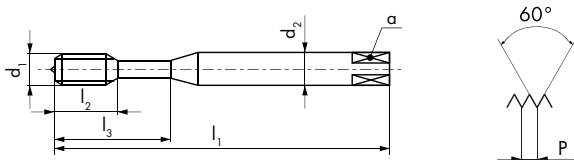



$\varnothing d_1$ MF	P mm	l_1 mm	l_2 mm	l_3 mm	d_2 mm	a mm			ID	ID	ID	ID ^{6H} + mm
4	0.5	63	7.5	21	4.5	3.4	3	3.5	● 101632	● 101712	● 111618	● 101631 0.020
5	0.5	70	9	25	6	4.9	3	4.5	● 101641	● 101714	● 111617	● 101640 0.020
6	0.5	80	11	30	6	4.9	3	5.5	● 101648	● 143990		
6	0.75	80	11	30	6	4.9	3	5.25	● 101650	● 101716	● 101702	● 101649 0.022
8	0.75	90	12.5	35	8	6.2	3	7.25	● 101658	● 101719		● 101657 0.022
8	1	90	12.5	35	8	6.2	3	7	● 101660	● 101720	● 101704	● 101659 0.026
10	0.75	100	14	39	10	8	3	9.25	● 101606	● 144401		
10	1	100	14	39	10	8	3	9	● 101608	● 101706	● 101695	● 101607 0.026
10	1.25	100	14	39	10	8	3	8.8	● 101609	● 105134	● 110965	

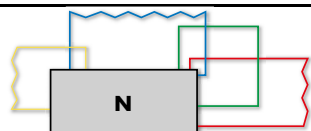

								N460-3	N460V-3	N460TN-3	N460-3
<p>N460-3 63 72 73 74 81 91</p> <p>N460V-3 11 12 32</p> <p>N460TN-3 11 12 13 14 32</p>											
								< 2.5 x D	< 2.5 x D	< 2.5 x D	< 2.5 x D
								2.5 x P	2.5 x P	2.5 x P	2.5 x P
$\emptyset d_1$ MF	P mm	l_1 mm	l_2 mm	d_2 mm	a mm			ID	ID	ID	ID ^{6H} + mm
12	1	100	14	9	7	3	11	● 102353	● 102462	● 102447	● 102352 0.026
12	1.25	100	14	9	7	3	10.8	● 102354	● 102463	● 144202	
12	1.5	100	14	9	7	3	10.5	● 102356	● 102464	● 102448	● 102355 0.032
13	1	100	14	11	9	3	12	● 102364			
14	1	100	14	11	9	3	13	● 102365	● 102466		
14	1.5	100	14	11	9	3	12.5	● 102367	● 102467	● 102450	● 102366 0.032
15	1	100	14	12	9	3	14	● 102370			
15	1.5	100	18	12	9	3	13.5	● 102371			
16	1	100	14	12	9	4	15	● 102372	● 102469		
16	1.5	100	14	12	9	4	14.5	● 102374	● 102470	● 102452	● 102373 0.032
18	1	110	18	14	11	4	17	● 102380	● 143926		
18	1.5	110	18	14	11	4	16.5	● 102382	● 102472	● 145346	● 102381 0.032
20	1	125	20	16	12	4	19	● 102384	● 146377		
20	1.5	125	20	16	12	4	18.5	● 102386	● 102474	● 148780	
20	2	140	24	16	12	4	18	● 102387	● 143566		
22	1	125	20	18	14.5	4	21	● 102392	● 147702		
22	1.5	125	20	18	14.5	4	20.5	● 102393	● 102476		
24	1.5	140	22	18	14.5	4	22.5	● 102396	● 102478		
24	2	140	22	18	14.5	4	22	● 102397	● 102479		
25	1.5	140	22	18	14.5	4	23.5	● 102399	● 143810		
26	1.5	140	22	18	14.5	4	24.5	● 102400	● 143952		
27	1.5	140	22	20	16	4	25.5	● 102401	● 143965		
27	2	140	22	20	16	4	25	● 102402	● 144201		
28	1.5	140	22	20	16	4	26.5	● 102403	● 144997		



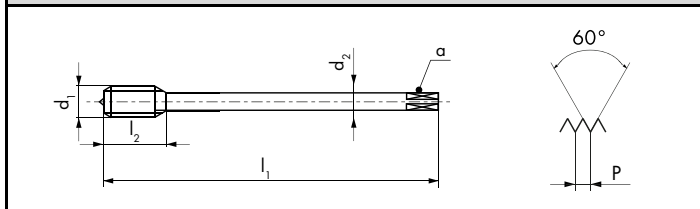
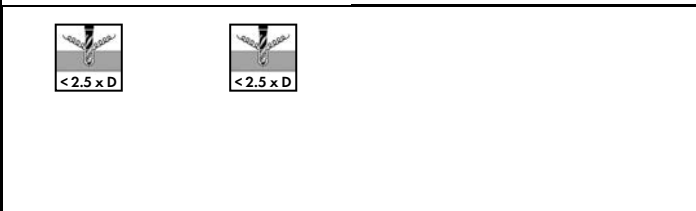

N460-3  **63** **72** **73** **74** **81** **91**

N460V-3   **11** **12** **32**



	
ISO 2 6H	ISO 2 6H

$\emptyset d_1$ MF	P mm	l_1 mm	l_2 mm	d_2 mm	a mm			ID	ID
30	1.5	150	24	22	18	4	28.5	● 102404	● 142524
30	2	150	24	22	18	4	28	● 102405	● 142581
32	1.5	150	24	22	18	4	30.5	● 102406	● 143605
33	2	160	26	25	20	4	31	● 102407	● 147604
33	3	180	33	25	20	4	30	● 175437	● 150448
35	1.5	170	24	28	22	5	33.5	● 102408	● 146846
36	1.5	170	24	28	22	5	34.5	● 102409	● 143824
36	2	170	28	28	22	5	34	● 175436	● 164870
36	3	200	36	28	22	4	33	● 115072	● 150453
39	3	200	40	32	24	5	36	● 174995	● 122669
42	3	200	40	32	24	5	39	● 174996	● 150436

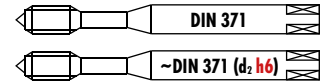

										Z320V-4	Z320VS-4	Z360V-3	Z370VS-3	
Z320V-4		V	11 12 13 21 32											
Z320VS-4		VS	11 12 13 14 21 22 23 32 61 63 94											
Z360V-3		V	12 21 32											
Z370VS-3		VS		14 15 21 22 23 24 51 61 94										
Z370VS-3		VS		13 14 15 21 22 23 24 51 52										PM
										ISO 2 6H	ISO 2 6H	ISO 2 6H	6HX	
Ø d₁	P	l₁	l₂	l₃	d₂	a				ID	ID			
* 3	0.35	56	12	18	3.5	2.7	3	2.65		● 115468				
6	0.75	80	17	30	6	4.9	3	5.25		● 142726	● 123691			
8	1	90	20	35	8	6.2	3	7		● 142727	● 124289			
10	1	100	22	39	10	8	3	9		● 142728	● 120060			
10	1.25	100	22	39	10	8	3	8.8		● 196023	● 196024			
Ø d₁	P	l₁	l₂	l₃	d₂	a					ID			
4	0.5	63	7.5	21	4.5	3.4	3	3.5			● 104675			
5	0.5	70	9	25	6	4.9	3	4.5			● 104676			
6	0.75	80	11	30	6	4.9	3	5.25			● 104677			
8	1	90	12.5	35	8	6.2	3	7			● 104678			
10	1	100	14	39	10	8	3	9			● 104674			
Ø d₁	P	l₁	l₂	l₃	d₂ h6	a					ID			
6	0.75	80	11	30	6	4.9	3	5.25			● 166117			
8	1	90	12.5	35	8	6.2	3	7			● 166118			
10	1	100	14	39	10	8	3	9			● 166119			
10	1.25	100	14	39	10	8	3	8.8			● 196020			
*Z320V-3														

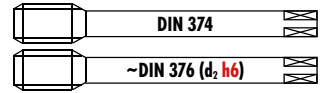

									Z420V-4	Z420VS-4	Z460V-3	Z470VS-3	
Z420V-4		V	11 12 13 21 32										
Z420VS-4		VS	11 12 13 14 21 22 23 32 61 63 94										
Z460V-3		V	12 21 32										
Z470VS-3		VS	CLASSIC	14 15 21 22 23 24 51 61 94									
Z470VS-3		VS	SYNCHRO	13 14 15 21 22 23 24 51 52									PM
									B 4 x P	B 4 x P	C 2.5 x P	C 2.5 x P	
									ISO 2 6H	ISO 2 6H	ISO 2 6H	6HX	
Ø d ₁ MF	P mm	l ₁ mm	l ₂ mm	d ₂ mm	a mm				ID	ID			
12	1	100	24	9	7	3	11		● 142729				
12	1.5	100	24	9	7	3	10.5		● 142730	● 120421			
14	1.5	100	24	11	9	3	12.5		● 142731	● 120688			
16	1.5	100	26	12	9	3	14.5		● 142732	● 120878			
18	1.5	110	26	14	11	4	16.5		● 196025	● 196027			
20	1.5	125	28	16	12	4	18.5		● 163931	● 196026			
Ø d ₁ MF	P mm	l ₁ mm	l ₂ mm	d ₂ mm	a mm					ID			
12	1	100	14	9	7	3	11			● 104729			
12	1.5	100	14	9	7	3	10.5			● 104730			
14	1.5	100	14	11	9	3	12.5			● 104731			
16	1.5	100	14	12	9	4	14.5			● 104732			
18	1.5	110	18	14	11	4	16.5			● 104733			
20	1.5	125	20	16	12	4	18.5			● 104734			
22	1.5	125	20	18	14.5	4	20.5			● 104735			
24	1.5	140	22	18	14.5	4	22.5			● 104736			
24	2	140	22	18	14.5	4	22			● 104737			
Ø d ₁ MF	P mm	l ₁ mm	l ₂ mm	d ₂ h ₆ mm	a mm					ID			
12	1.5	110	14	* 10	* 8	4	10.5			● 166120			
14	1.5	110	14	* 12	* 9	4	12.5			● 166121			
16	1.5	110	18	12	9	4	14.5			● 166122			
18	1.5	125	21	14	11	4	16.5			● 196021			
20	1.5	140	24	16	12	4	18.5			● 196022			
									* Norme DC / * DC Norm / * Norma DC				

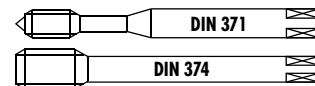

										H320-4	H420-4	H320TC-4	H420TC-4	
H320-4		15 16 62 64 82												
H420-4		15 16 62 64 82										NEW	NEW	
H320TC-4		TiCN	15 16 24 31 82 83 92 93											
H420TC-4		TiCN	15 16 24 31 82 83 92 93											
$\emptyset d_1$ MF	P mm	l_1 mm	l_2 mm	l_3 mm	d_2 mm	a mm				ID	ID	ID	ID	
6	0.75	80	17	30	6	4.9	3	5.25	● 101214		● 196035			
8	0.75	90	20	35	8	6.2	3	7.25	● 101216					
8	1	90	20	35	8	6.2	3	7	● 101217		● 196036			
10	1	100	22	39	10	8	3	9	● 101204		● 172963			
10	1.25	100	22	39	10	8	3	8.8	● 175213		● 173079			
12	1.25	100	24		9	7	4	10.8		● 101273				
12	1.5	100	24		9	7	4	10.5		● 101274		● 196037		
14	1.5	100	24		11	9	4	12.5		● 101276		● 164053		
16	1.5	100	26		12	9	4	14.5		● 101278		● 196038		
18	1.5	110	26		14	11	4	16.5		● 101280		● 196039		
20	1.5	125	28		16	12	4	18.5		● 101282		● 148362		
24	2	140	34		18	14.5	4	22		● 101285				

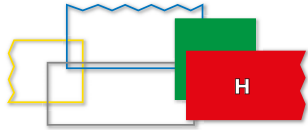
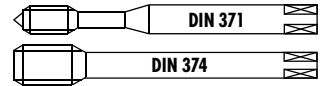

H350-3		15 16 62 64 82
H450-3		15 16 62 64 82
H350TC-3		15 16 24 31 82 83 92 93
H450TC-3		15 16 24 31 82 83 92 93

H350-3	H450-3	H350TC-3	H450TC-3
< 1.5 x D	< 1.5 x D	< 1.5 x D	< 1.5 x D

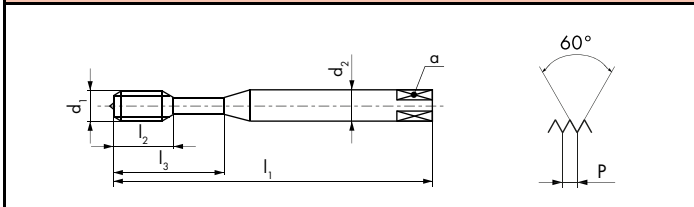

ISO 2 6H	ISO 2 6H	ISO 2 6H	ISO 2 6H

Ø d ₁ MF	P mm	l ₁ mm	l ₂ mm	l ₃ mm	d ₂ mm	a mm			ID	ID	ID	ID
6	0.75	80	11	30	6	4.9	3	5.25	● 101249		● 196033	
8	0.75	90	12.5	35	8	6.2	3	7.25	● 101252			
8	1	90	12.5	35	8	6.2	3	7	● 101253		● 150356	
10	1	100	14	39	10	8	3	9	● 101235		● 148753	
10	1.25	100	14	39	10	8	3	8.8	● 145590		● 196034	
12	1	100	14		9	7	4	11		● 101302		
12	1.5	100	14		9	7	4	10.5		● 101303		● 145561
14	1.5	100	14		11	9	4	12.5		● 101306		● 184003
16	1.5	100	14		12	9	4	14.5		● 101308		● 176013
18	1.5	110	18		14	11	4	16.5		● 101310		● 160146
20	1.5	125	20		16	12	4	18.5		● 101312		● 160147
22	1.5	125	20		18	14.5	4	20.5		● 101314		
24	1.5	140	22		18	14.5	4	22.5		● 101316		
24	2	140	22		18	14.5	4	22		● 101317		
27	2	140	22		20	16	4	25		● 101319		
30	1.5	150	24		22	18	4	28.5		● 101321		
30	2	150	24		22	18	4	28		● 101322		

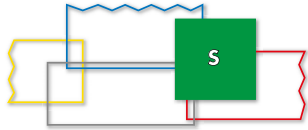

S320VS-4		VS	13 15 16 22 23 24 52
S420VS-4		VS	13 15 16 22 23 24 52
S360VS-3		VS	13 15 16 22 23 24 52
S460VS-3		VS	13 15 16 22 23 24 52

S320VS-4	S420VS-4	S360VS-3	S460VS-3

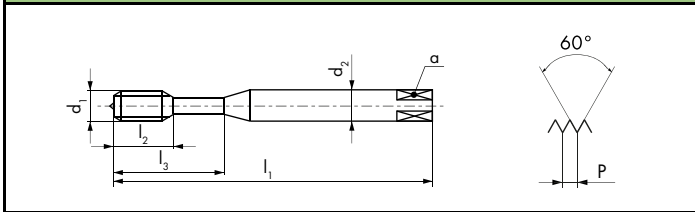

6HX	6HX	6HX	6HX

Ø d ₁ MF	P mm	l ₁ mm	l ₂ mm	l ₃ mm	d ₂ mm	a mm		
6	0.75	80	17	30	6	4.9	3	5.25
8	1	90	20	35	8	6.2	3	7
10	1	100	22	39	10	8	3	9
12	1.5	100	24		9	7	4	10.5
14	1.5	100	24		11	9	4	12.5
16	1.5	100	26		12	9	4	14.5

ID	ID
★ 123690	
● 124288	
● 120059	
	● 120420
	● 120687
	● 120877

Ø d ₁ MF	P mm	l ₁ mm	l ₂ mm	l ₃ mm	d ₂ mm	a mm		
8	1	90	12.5	35	8	6.2	3	7
10	1	100	14	39	10	8	3	9
12	1.5	100	14		9	7	4	10.5
14	1.5	100	14		11	9	4	12.5
16	1.5	100	14		12	9	4	14.5

ID	ID
	● 111528
	● 111529
	● 111540
	● 111541
	● 111542

aero

SA390-3



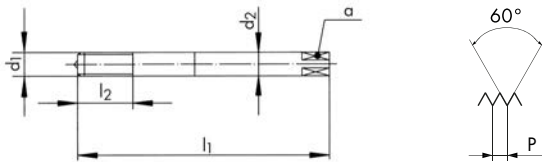

16 53

SA390-3



6HX

$\varnothing d_1$ MF	P mm	l_1 mm	l_2 mm	d_2 mm	a mm			ID
10	1	100	30	10	8	3	9	* 149751
12	1	110	35	12	9	4	11	* 149769
12	1.5	110	35	12	9	4	10.5	* 149773
14	1.5	110	40	16	12	4	12.5	* 149790

aero

SA320-4 **15 16 52 64**

SA350-3 **R15 15 16 52 64**

TL320VS-4 **VS 41 42**

TL351VS-3 **R15 VS 41 42**

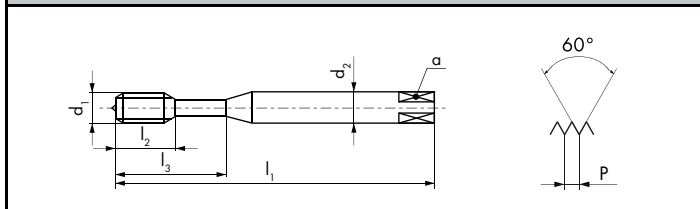

$\emptyset d_1$ MF	P mm	l_1 mm	l_2 mm	l_3 mm	d_2 mm	a mm		
4	0.5	63	14		4.5	3.4	3	3.5
5	0.5	70	15		6	4.9	3	4.5
6	0.5	80	15	23	6	4.9	3	5.5
8	1	90	18	29	8	6.2	3	7
10	1	100	20	33	10	8	3	9

$\emptyset d_1$ MF	P mm	l_1 mm	l_2 mm	l_3 mm	d_2 mm	a mm		
4	0.5	63	14		4.5	3.4	3	3.5
5	0.5	70	15		6	4.9	3	4.5
6	0.5	80	15	23	6	4.9	3	5.5
8	1	90	18	29	8	6.2	3	7
10	1	100	20	33	10	8	3	9

SA320-4	SA350-3	TL320VS-4	TL351VS-3
---------	---------	-----------	-----------

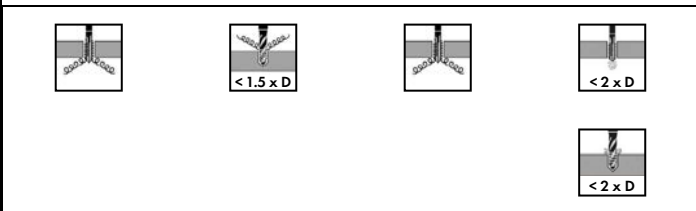

B 4 x P	C 2.5 x P	B 4 x P	C 2.5 x P
4HX	4HX	4HX	4HX





















ID	ID	ID	ID
	* 149079		● 152033
	● 149144		● 152049
* 149193		* 152058	● 152059
● 149304	● 149306		● 152080
● 149362	● 149364		● 152093

6HX	6HX	6HX	6HX
------------	------------	------------	------------

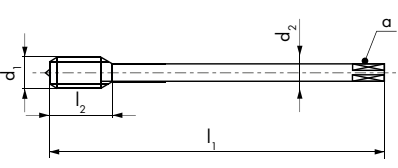
ID	ID	ID	ID
● 149081	● 149083		● 152035
● 149146	● 149148		● 152051
	* 149199		● 152061
● 149308	● 149310		● 148019
● 149366	● 149368	* 152094	● 148026



aero

								SA420-4	SA450-3	TL420VS-4	TL451VS-3
SA420-4  15 16 52 64								   			
SA450-3  R15 15 16 52 64											
TL420VS-4   41 42								  < 1.5 x D   < 2 x D			
TL451VS-3  R15   41 42											
 								B 4 x P C 2.5 x P B 4 x P C 2.5 x P			
Ø d₁	P	l₁	l₂	d₂	a			ID	ID	ID	ID
12	1	100	19	9	7	4	11	* 152209		* 152218	
12	1.5	100	24	9	7	4	10.5		* 152213		
16	1.5	100	26	12	9	4	14.5		* 152216		* 152226
								6HX 6HX 6HX 6HX			
Ø d₁	P	l₁	l₂	d₂	a						
12	1	100	19	9	7	4	11	* 152228		* 152237	
12	1.5	100	24	9	7	4	10.5	* 152227			
14	1.5	100	24	11	9	4	12.5		* 152233	* 152238	
16	1	100	23	12	9	4	15				* 152244
16	1.5	100	26	12	9	4	14.5		* 152235		

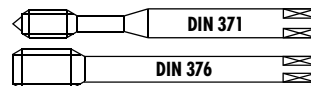

K

K313TC-3

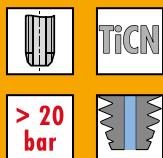

K413TC-3

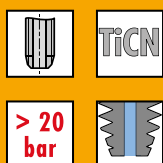

K313TC-3

K413TC-3

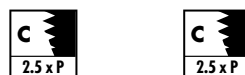
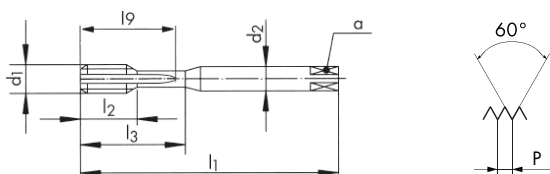

Ø d ₁ MF	P mm	l ₁ mm	l ₂ mm	l ₃ mm	l ₉ mm	d ₂ mm	a mm		
10	1	100	22	39	37	10	8	3	9
10	1.25	100	22	39	37	10	8	3	8.8
12	1	110	24		42	9	7	3	11
12	1.25	110	24		42	9	7	3	10.8
12	1.5	110	24		42	9	7	3	10.5
14	1.5	110	28		49	11	9	3	12.5
16	1.5	110	30		56	12	9	3	14.5
20	1.5	140	36		70	16	12	5	18.5

ID

ID

- 175729
- 196067

- 175731
- 175733
- 175735
- 175737
- 175739
- 171205

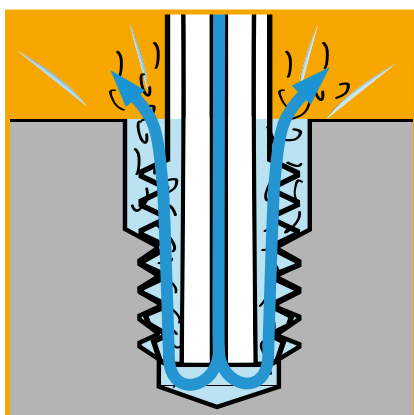



PM

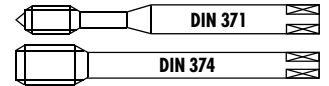

QTAP

Q320VS-4

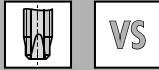

Q420VS-4



Q323VS-4

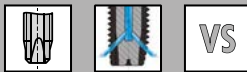

Q423VS-4



- 11 12 13 14
- 15 21 22 23
- 24 31 32 51
- 52 61 62 63
- 64 71 72 73
- 74 81 82 83
- 91 92 94

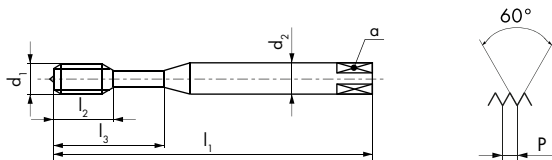

Q320VS-4

Q420VS-4

Q323VS-4

Q423VS-4



NEW



NEW



NEW



NEW





ISO 2
6H

ISO 2
6H

ISO 2
6H

ISO 2
6H

Ø d ₁ MF	P mm	l ₁ mm	l ₂ mm	l ₃ mm	d ₂ mm	a mm		
6	0.75	80	17	30	6	4.9	3	5.25
8	1	90	20	35	8	6.2	3	7
10	1	100	22	39	10	8	3	9
12	1	100	24		9	7	3	11
12	1.5	100	24		9	7	3	10.5
14	1.5	100	24		11	9	3	12.5
16	1.5	100	26		12	9	3	14.5
18	1.5	110	26		14	11	4	16.5
20	1.5	125	28		16	12	4	18.5

ID

ID

ID

ID

● 197661

● 197684

● 197662

● 197685

● 197663

● 197686

● 197664

● 197687

● 197665

● 197688

● 197666

● 197689

● 197667

● 197690

● 197668

● 197691

● 197669

● 197692



≤ Ø 16 > Ø 16

PM HSSE

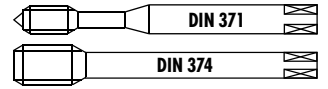

QTAP

Q360VS-3



Q460VS-3



Q363VS-3



Q463VS-3

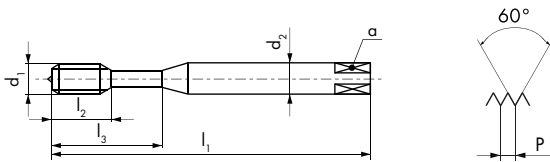

Q360VS-3

Q460VS-3

Q363VS-3

Q463VS-3



NEW



NEW



NEW



NEW



< 2.5 x D



< 2.5 x D



< 2.5 x D



< 2.5 x D



ISO 2 6H



ISO 2 6H



ISO 2 6H



ISO 2 6H

Ø d ₁ MF	P mm	l ₁ mm	l ₂ mm	l ₃ mm	d ₂ mm	a mm		
4	0.5	63	7.5	21	4.5	3.4	3	3.5
5	0.5	70	9	25	6	4.9	3	4.5
6	0.75	80	11	30	6	4.9	3	5.25
8	1	90	12.5	35	8	6.2	3	7
10	1	100	14	39	10	8	3	9
12	1	100	14		9	7	3	11
12	1.5	100	14		9	7	3	10.5
14	1.5	100	14		11	9	3	12.5
16	1.5	100	14		12	9	4	14.5
18	1.5	110	18		14	11	4	16.5
20	1.5	125	20		16	12	4	18.5
22	1.5	125	20		18	14.5	4	20.5
24	1.5	140	22		18	14.5	4	22.5
24	2	140	22		18	14.5	4	22

ID

ID

ID

ID

● 197670		● 197693	
● 197671		● 197694	
● 197672		● 197695	
● 197673		● 197696	
● 197674		● 197697	
	● 197675		● 197698
	● 197676		● 197699
	● 197677		● 197700
	● 197678		● 197701
	● 197679		● 197702
	● 197680		● 197703
	● 197681		● 197704
	● 197682		● 197705
	● 197683		● 197706



Uniquement pour taraudage synchro
Nur für Synchrobearbeitung
Only for rigid tapping
Solo per mescolatura sincrona
Solo para resacado sincronizado
Только для rigid tapping

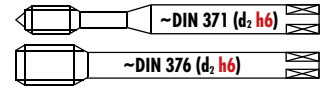

RTS

Rigid Tapping Synchro

RTS320VS-4		VS	11 12 13 14 15 21 31 32 51 61 63 64 72 73 74 81 82 83 91 92 94
RTS420VS-4		VS	11 12 13 14 15 21 31 32 51 61 63 64 72 73 74 81 82 83 91 92 94
RTS362VS-3		VS	11 12 13 14 15 21 31 32 51 61 63 64 72 73 74 81 82 83 91 92 94
RTS462VS-3		VS	11 12 13 14 15 21 31 32 51 61 63 64 72 73 74 81 82 83 91 92 94

RTS320VS-4	RTS420VS-4	RTS362VS-3	RTS462VS-3
------------	------------	------------	------------



		< 2.5 x D	< 2.5 x D

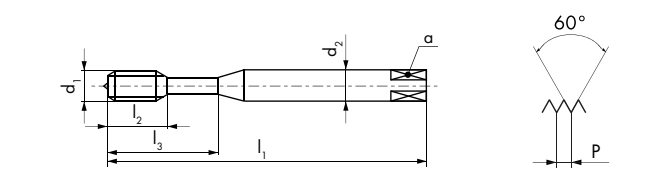

6HX	6HX	6HX	6HX

Ø d ₁ MF	P mm	l ₁ mm	l ₂ mm	l ₃ mm	d ₂ h6 mm	a mm		
8	1	90	12.5	35	8	6.2	3	7
10	1	100	14	39	10	8	3	9
12	1.5	110	14		* 10	* 8	3	10.5
14	1.5	110	14		* 12	* 9	3	12.5
16	1.5	110	18		12	9	3	14.5

* Norme DC / * DC Norm / * Norma DC

ID	ID
● 150615	
● 150630	
	● 150640
	● 150655
	● 150665

Ø d ₁ MF	P mm	l ₁ mm	l ₂ mm	l ₃ mm	d ₂ h6 mm	a mm		
8	1	90	12.5	35	8	6.2	3	7
10	1	100	14	39	10	8	3	9
12	1.5	110	14		* 10	* 8	3	10.5
14	1.5	110	14		* 12	* 9	3	12.5
16	1.5	110	18		12	9	3	14.5

* Norme DC / * DC Norm / * Norma DC

ID	ID
	● 150617
	● 150632
	● 151862
	● 151869
	● 151871





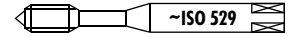



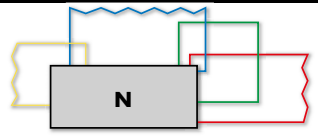
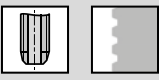

sur demande
auf Anfrage
on request
su richiesta
sobre pedido
no zampocy

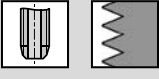
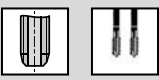
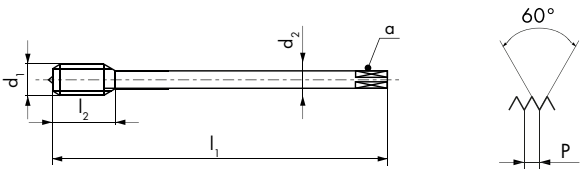
≥ Ø 6 mm



										N1110-1	N1110-3	N1110-S	
										<p>N1110-1 </p> <p>N1110-3 31 62 73 74 91</p> <p>N1110-S </p>			
Ø d ₁ MF	P mm	l ₁ mm	l ₂ mm	l ₃ mm	d ₂ mm	a mm			ID	ID	ID		
2	0.25	45	8		2.8	2.1	3	1.75		● 102933			
2.2	0.25	45	9.5		2.8	2.1	3	1.95		● 102936			
2.5	0.35	45	9.5		2.8	2.1	3	2.15		● 102940			
3	0.35	48	11	18	3.15	2.5	3	2.65		● 102945			
3.5	0.35	50	13	20	3.55	2.8	3	3.15		● 102949			
4	0.35	53	13	21	4	3.15	3	3.65		● 102952			
4	0.5	53	13	21	4	3.15	3	3.5	● 102773	● 102953	● 111040		
4.5	0.5	53	13	21	4.5	3.55	3	4		● 102958			
5	0.35	58	16	25	5	4	3	4.65		● 102960			
5	0.5	58	16	25	5	4	3	4.5	● 102778	● 102961	● 111045		
5	0.75	58	16	25	5	4	3	4.25		● 102963			
5.5	0.5	62	17	26	5.6	4.5	3	5		● 102967			
6	0.5	66	19	30	6.3	5	3	5.5	● 102783	● 102969	● 111050		
6	0.75	66	19	30	6.3	5	3	5.25	● 102784	● 102971	● 111051		
7	0.5	66	19	30	7.1	5.6	3	6.5		● 102975			
8	0.75	72	22	35	8	6.3	3	7.25	● 102790	● 102982	● 111057		
8	1	72	22	35	8	6.3	3	7	● 102791	● 102984	● 111058		
9	0.5	72	22	36	9	7.1	3	8.5		● 102988			
9	0.75	72	22	36	9	7.1	3	8.25		● 102989			
9	1	72	22	36	9	7.1	3	8		● 102990			
10	0.5	80	24	39	10	8	3	9.5		● 102925			
10	1	80	24	39	10	8	3	9	● 102756	● 102928	● 111024		
10	1.25	80	24	39	10	8	3	8.8	● 102758	● 102930	● 111025		
										<p>P 0.25</p>			

								N1210-1	N1210-3	N1210-S	
N1210-1											
N1210-3											
N1210-S											
$\emptyset d_1$ MF	P mm	l_1 mm	l_2 mm	d_2 mm	a mm			ID	ID	ID	
11	0.5	85	22	8	6.3	3	10.5		● 103485		
11	0.75	85	22	8	6.3	3	10.25		● 103486		
11	1	85	22	8	6.3	3	10		● 103487		
11	1.25	85	22	8	6.3	3	9.8		● 103488		
12	0.5	89	24	9	7.1	3	11.5		● 103490		
12	0.75	89	24	9	7.1	3	11.25		● 103491		
12	1	89	24	9	7.1	3	11	● 103305	● 103493	● 111169	
12	1.25	89	24	9	7.1	3	10.8	● 103307	● 103495	● 111171	
12	1.5	89	24	9	7.1	3	10.5	● 103308	● 103497	● 111172	
14	0.5	95	24	11.2	9	3	13.5		● 103502		
14	0.75	95	24	11.2	9	3	13.25		● 103503		
14	1	95	24	11.2	9	3	13	● 103312	● 103504	● 111175	
14	1.25	95	24	11.2	9	3	12.8	● 103314	● 103506	● 111177	
14	1.5	95	24	11.2	9	3	12.5	● 103315	● 103508	● 111178	
15	0.75	90	23	11.2	9	3	14.25		● 103512		
15	1	90	23	11.2	9	3	14		● 103513		
16	0.5	102	32	12.5	10	4	15.5		● 103515		
16	0.75	102	32	12.5	10	4	15.25		● 103516		
16	1	102	32	12.5	10	4	15	● 103321	● 103517	● 111183	
16	1.5	102	32	12.5	10	4	14.5	● 103322	● 103520	● 111184	
17	1	95	23	12.5	10	4	16		● 103525		
18	0.75	112	30	14	11.2	4	17.25		● 103527		
18	1	112	30	14	11.2	4	17	● 103326	● 103528	● 111187	
18	1.5	112	30	14	11.2	4	16.5	● 103327	● 103531	● 111188	
18	2	112	30	14	11.2	3	16		● 103533		
19	1	112	33	14	11.2	4	18		● 103536		

									N1210-1	N1210-3	N1210-S
									<p>N1210-1</p> 		
<p>N1210-3</p>  <p>31 62 73 74 91</p>											
<p>N1210-S</p> 											
											
											
$\emptyset d_1$ MF	P mm	l_1 mm	l_2 mm	d_2 mm	a mm			ID	ID	ID	
20	1	112	37	14	11.2	4	19	● 103332	● 103537	● 111198	
20	1.25	112	37	14	11.2	4	18.8		● 103539		
20	1.5	112	37	14	11.2	4	18.5	● 103334	● 103540	● 111195	
22	1	115	32	16	12.5	4	21		● 103545		
22	1.5	115	32	16	12.5	4	20.5	● 103340	● 103546	● 121669	
22	2	115	32	16	12.5	3	20		● 103548		
24	1	120	30	18	14	4	23		● 103552		
24	1.5	120	30	18	14	4	22.5	● 103343	● 103553	● 111202	
24	2	130	45	18	14	4	22	● 103344	● 103555	● 111203	
25	1	120	30	18	14	4	24		● 103559		
25	1.5	120	30	18	14	4	23.5		● 103560		
25	2	120	30	18	14	4	23		● 103561		
26	1	120	30	18	14	4	25		● 103562		
26	1.5	120	30	18	14	4	24.5	● 103346	● 103563	● 111207	
26	2	120	30	18	14	4	24		● 103564		
27	1	127	30	20	16	4	26		● 103565		
27	1.5	127	30	20	16	4	25.5		● 103566		
27	2	135	45	20	16	4	25	★ 103351	★ 103567	★ 111210	
28	1	127	30	20	16	4	27		● 103570		
28	1.5	127	30	20	16	4	26.5		● 103571		
30	1.5	127	32	20	16	4	28.5	● 103355	● 103575	● 111214	
30	2	127	32	20	16	4	28	● 103356	● 103577	● 111215	

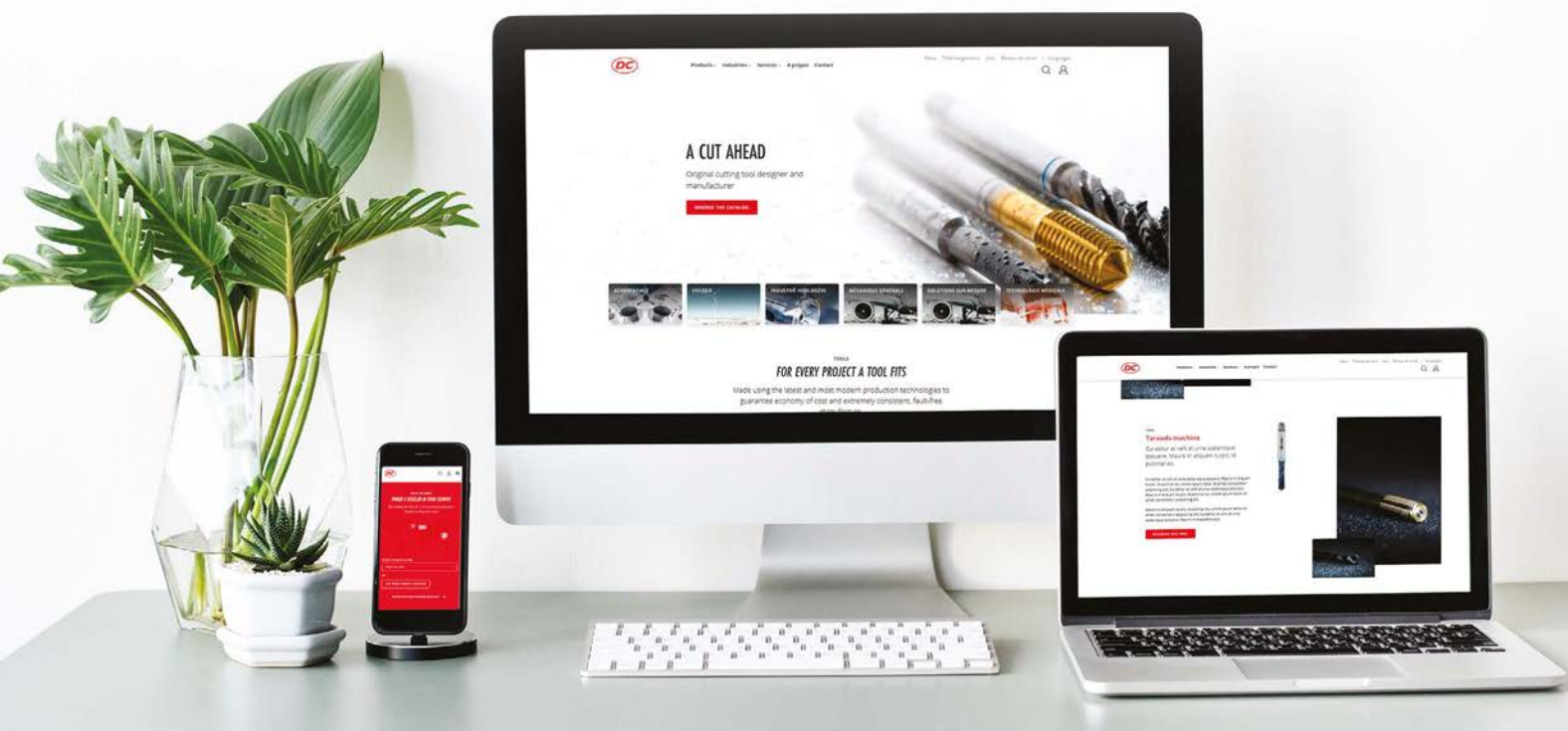

























































NOUVEAU SITE WEB
EN CONSTRUCTION — EN LIGNE POUR L'ÉTÉ 2021.









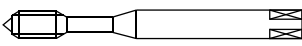
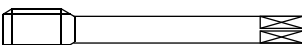









NUOVO SITO WEB
IN COSTRUZIONE — ONLINE PER L'ESTATE DEL 2021.



		N						
Caractéristiques Caratteristiche								
					NEW			NEW
Genre de trou Tipo di foro								
		N310-3	N320-3 N320-4	N320V-4	N320TN-4	N360-3	N360V-3	N360TN-3
<i>DIN longue</i> <i>DIN lungo</i>	DIN 371	154	154	154	154	156	156	156
<i>ISO courte</i> <i>ISO corto</i>	ISO 529							
<i>Tolérance</i> <i>Tolleranza</i>	UNC 2B	154	154	154	154	156	156	156
<i>Tolérance</i> <i>Tolleranza</i>	UNC 3B							
<i>Tolérance</i> <i>Tolleranza</i>	UNC(J) 3B		154			156		
		N410-3	N420-4	N420V-4	N420TN-4	N460-3	N460V-3	N460TN-3
<i>DIN longue</i> <i>DIN lungo</i>	DIN 376	155	155	155	155	157	157	157
<i>ISO courte</i> <i>ISO corto</i>	ISO 529							
<i>Tolérance</i> <i>Tolleranza</i>	UNC 2B	155	155	155	155	157	157	157
<i>Tolérance</i> <i>Tolleranza</i>	UNC 3B							
<i>Tolérance</i> <i>Tolleranza</i>	UNC(J) 3B							

N	Z				H			
 	 	 	 	 		 	 	 
						 <div style="background-color: red; color: white; padding: 2px; font-size: 8px; margin-top: 5px;">NEW</div>		 <div style="background-color: red; color: white; padding: 2px; font-size: 8px; margin-top: 5px;">NEW</div>
								
N1110 -1 -2 -3 -S	Z320V-3 Z320V-4	Z320VS-4	Z360V-3 Z362V-3	Z370VS-3	H320-4	H320TC-4	H350-3	H350TC-3
170	158	158	159	160	161	161	162	162
170	158	158	159	160	161	161	162	162
170				160				
N1210 -1 -2 -3 -S	Z420V-4	Z420VS-4	Z462V-3	Z470VS-3	H420-4	H420TC-4	H450-3	H450TC-3
171	158	158	159	160	161	161	162	162
171	158	158	159	160	161	161	162	162

		S		SA			TL	
Caractéristiques Caratteristiche		 VS	 R35 VS		 R15	 R10	 VS	 R15  VS
								
Genre de trou Tipo di foro								
		S320VS-4	S360VS-3	SA320-4	SA350-3	SA390-3	TL320VS-4	TL351VS-3
DIN longue DIN lungo	DIN 371	163	164	165	165	166	165	165
ISO courte ISO corto	ISO 529							
Tolérance Tolleranza	UNC 2B	163	164	165	165		165	165
Tolérance Tolleranza	UNC 3B							
Tolérance Tolleranza	UNC(J) 3B	163		165	165	166	165	165
		S420VS-4	S460VS-3	SA420-4	SA450-3			
DIN longue DIN lungo	DIN 376	163	164	166	166			
ISO courte ISO corto	ISO 529							
Tolérance Tolleranza	UNC 2B	163	164	166	166			
Tolérance Tolleranza	UNC 3B							
Tolérance Tolleranza	UNC(J) 3B							

Q				RTS	
 VS	 VS	 R40 VS	 R40 VS	 VS	 R40 VS
 NEW	 NEW	 NEW	 NEW		
					
Q320VS-4	Q323VS-4	Q360VS-3	Q363VS-3	RTS320VS-4	RTS362VS-3
167	167	168	168	169	169
167	167	168	168	169	169
Q420VS-4	Q423VS-4	Q460VS-3	Q463VS-3	RTS420VS-4	RTS462VS-3
167	167	168	168	169	169
167	167	168	168	169	169

UNC ASME B1.1

HSSE



										N410-3	N420-4	N420V-4	N420TN-4					
										N410-3		31 62 73 74 91	N420-4		62 63 64 72 73 74 81 91	N420V-4		V
										 2B	 2B	 2B	 2B					
Ø" d ₁ UNC	P TPI	d ₁ mm	l ₁ mm	l ₂ mm	d ₂ mm	a mm			ID	ID	ID	ID						
5/16	18	7.93	90	20	6	4.9	3	6.5	● 101997	● 102213	● 142742	● 196007						
3/8	16	9.52	100	22	7	5.5	3	8	● 101996	● 102212	● 142743	● 158317						
7/16	14	11.11	100	19	8	6.2	3	9.3		● 102215	● 142744	● 196008						
1/2	13	12.7	110	24	9	7	3	10.8	● 101993	● 102208	● 142745	● 143827						
9/16	12	14.28	110	28	11	9	3	12.2		● 102217								
5/8	11	15.87	110	30	12	9	3	13.6	● 101998	● 102214	● 142746	● 146391						
3/4	10	19.05	125	33	14	11	3	16.6	● 101995	● 102211	● 142747	● 146054						
7/8	9	22.22	140	36	18	14.5	3	19.5		● 102216	● 142748							
1	8	25.4	160	39	18	14.5	4	22.3	● 101994	● 102209	● 142749							
1 1/8	7	28.57	180	45	22	18	4	25		● 102205								
1 1/4	7	31.75	180	45	22	18	4	28.2		● 102204								
1 1/2	6	38.1	200	55	32	24	4	34		● 102203								
1 3/4	5	44.45	220	59	36	29	4	39.5	★ 101992	● 102206								
2	4.5	50.8	250	67	40	32	4	45.3		● 102210								

UNC ASME B1.1

HSSE



										N460-3	N460V-3	N460TN-3
<p>N460-3 </p> <p>N460V-3 </p> <p>N460TN-3 </p>												
										2B	2B	2B
$\emptyset'' d_1$ UNC	P TPI	d_1 mm	l_1 mm	l_2 mm	d_2 mm	a mm				ID	ID	ID
7/16	14	11.11	100	14	8	6.2	3	9.3		● 102424	● 105135	● 196002
1/2	13	12.7	110	14	9	7	3	10.8		● 102420	● 102497	● 157376
9/16	12	14.28	110	14	11	9	3	12.2		● 102426	● 102502	
5/8	11	15.87	110	18	12	9	3	13.6		● 102423	● 102500	● 128252
3/4	10	19.05	125	21	14	11	3	16.6		● 102422	● 102499	● 143519
7/8	9	22.22	140	24	18	14.5	4	19.5		● 102425	● 102501	
1	8	25.4	160	27	18	14.5	4	22.3		● 102421	● 102498	
1 1/8	7	28.57	180	30	22	18	4	25		● 102418	● 102495	
1 1/4	7	31.75	180	30	22	18	4	28.2		● 102417	● 102494	
1 1/2	6	38.1	200	40	32	24	5	34		● 102416	● 102493	
1 3/4	5	44.45	220	44	36	29	5	39.5			● 128062	
2	4.5	50.8	250	52	40	32	5	45.3			● 128084	

UNC ASME B1.1

PM

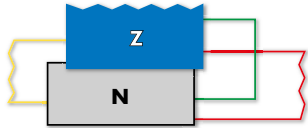
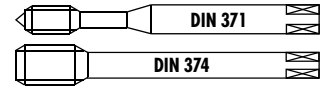

Z320V-4		V	11 12 13 21 32
Z320VS-4		VS	11 12 13 14 21 22 23 32 61 63 94
Z420V-4		V	11 12 13 21 32
Z420VS-4		VS	11 12 13 14 21 22 23 32 61 63 94

Z320V-4	Z320VS-4	Z420V-4	Z420VS-4
---------	----------	---------	----------

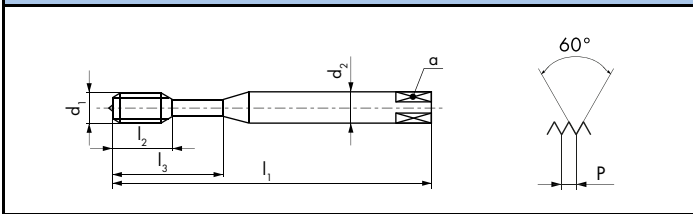
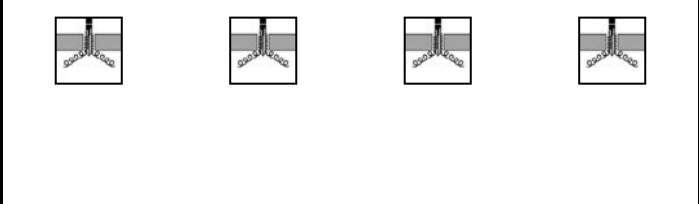

2B	2B	2B	2B

Ø" d ₁ UNC	P TPI	d ₁ mm	l ₁ mm	l ₂ mm	l ₃ mm	d ₂ mm	a mm			ID	ID	ID	ID
* 2	56	2.18	45	9		2.8	2.1	2	1.75	● 142750			
4	40	2.84	56	12	18	3.5	2.7	3	2.25	● 142751			
6	32	3.5	56	13	20	4	3	3	2.75	● 142752	● 111560		
8	32	4.16	63	14	21	4.5	3.4	3	3.4	● 142753	● 111561		
10	24	4.82	70	15	25	6	4.9	3	3.8	● 142754	● 111562		
1/4	20	6.35	80	17	30	7	5.5	3	5.1	● 142755	● 111563		
5/16	18	7.93	90	20	35	8	6.2	3	6.5	● 142756	● 111564		
3/8	16	9.52	100	22	39	10	8	3	8	● 142757	● 111565		
7/16	14	11.11	100	19		8	6.2	3	9.3				● 196028
1/2	13	12.7	110	24		9	7	3	10.8		● 142758	● 111566	
5/8	11	15.87	110	30		12	9	3	13.6		● 142759	● 111567	
3/4	10	19.05	125	33		14	11	4	16.6		● 142760	● 111568	
7/8	9	22.22	140	36		18	14.5	4	19.5		● 142761		
1	8	25.4	160	39		18	14.5	4	22.3		● 142762		

*Z320V-3

UNC ASME B1.1

≤ Ø 2.8 > Ø 2.8

PM HSSE

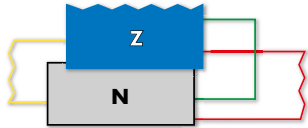
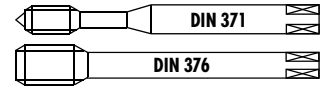

Z362V-3



Z462V-3



Z362V-3

Z462V-3

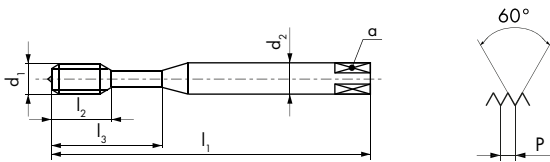

2B

2B

Ø" d ₁ UNC	P TPI	d ₁ mm	l ₁ mm	l ₂ mm	l ₃ mm	d ₂ mm	a mm			ID	ID
* 2	56	2.18	45	8		2.8	2.1	2	1.75	● 104695	
* 4	40	2.84	56	5.5	18	3.5	2.7	3	2.25	● 104697	
6	32	3.5	56	6.5	20	4	3	3	2.75	● 104699	
8	32	4.16	63	7.5	21	4.5	3.4	3	3.4	● 104700	
10	24	4.82	70	9	25	6	4.9	3	3.8	● 104694	
1/4	20	6.35	80	11	30	7	5.5	3	5.1	● 104693	
5/16	18	7.93	90	12.5	35	8	6.2	3	6.5	● 104698	
3/8	16	9.52	100	14	39	10	8	3	8	● 104696	
7/16	14	11.11	100	14		8	6.2	3	9.3		● 104757
1/2	13	12.7	110	14		9	7	3	10.8		● 104753
5/8	11	15.87	110	18		12	9	3	13.6		● 104756
3/4	10	19.05	125	21		14	11	3	16.6		● 104755
7/8	9	22.22	140	24		18	14.5	3	19.5		● 104758
1	8	25.4	160	27		18	14.5	4	22.3		● 104754

*Z360V-3

UNC ASME B1.1

PM

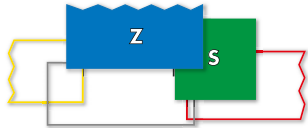
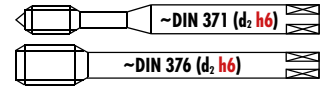

Z370VS-3 Z470VS-3

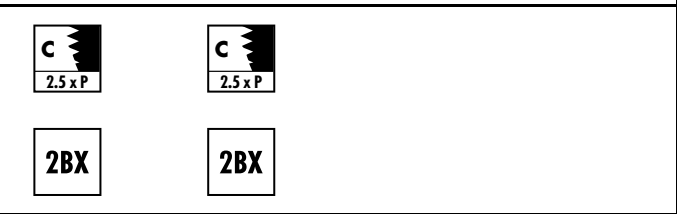

Z370VS-3 R45 VS CLASSIC

Z470VS-3 R45 VS CLASSIC

Z370VS-3 R45 VS SYNCHRO

Z470VS-3 R45 VS SYNCHRO

14 15 21 22 23
24 51 61 94

13 14 15 21 22
23 24 51 52

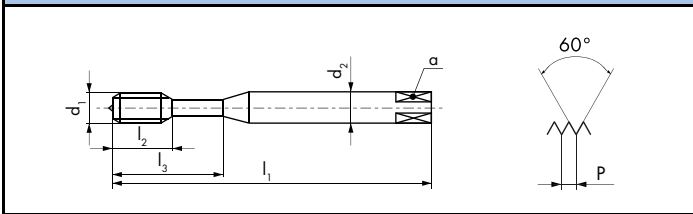

Ø" d ₁ UNC	P TPI	d ₁ mm	l ₁ mm	l ₂ mm	l ₃ mm	d ₂ h ₆ mm	a mm			
6	32	3.5	56	6.5	20	4 (h9)	3	3	2.75	● 166123
8	32	4.16	63	7.5	21	4.5(h9)	3.4	3	3.4	● 166124
10	24	4.82	70	9	25	6	4.9	3	3.8	● 166125
1/4	20	6.35	80	11	30	* 6	* 4.9	3	5.1	● 166126
5/16	18	7.93	90	12.5	35	8	6.2	3	6.5	● 166127
3/8	16	9.52	100	14	39	10	8	3	8	● 166128
7/16	14	11.11	100	14		8	6.2	3	9.3	● 166129
1/2	13	12.7	110	14		* 10	* 8	4	10.8	● 166130
5/8	11	15.87	110	18		12	9	4	13.6	● 166131
3/4	10	19.05	125	21		14	11	4	16.6	● 166132
1	8	25.4	160	27		16	12	4	22.3	● 175703

* Norme DC / * DC Norm/ * Norma DC

ID	ID
● 166123	
● 166124	
● 166125	
● 166126	
● 166127	
● 166128	
	● 166129
	● 166130
	● 166131
	● 166132
	● 175703

3B
UNC(J)

Ø" d ₁ UNC	P TPI	d ₁ mm	l ₁ mm	l ₂ mm	l ₃ mm	d ₂ h ₆ mm	a mm			
4	40	2.84	56	5.5	18	3.5(h9)	2.7	3	2.3	● 165114
6	32	3.5	56	6.5	20	4 (h9)	3	3	2.8	● 165115
8	32	4.16	63	7.5	21	4.5(h9)	3.4	3	3.45	● 165116
1/4	20	6.35	80	11	30	* 6	* 4.9	3	5.2	● 165117
5/16	18	7.93	90	12.5	35	8	6.2	3	6.7	● 165118

* Norme DC / * DC Norm/ * Norma DC

ID
● 165114
● 165115
● 165116
● 165117
● 165118

UNC ASME B1.1

PM

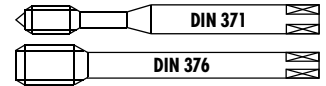

										H320-4	H420-4	H320TC-4	H420TC-4	
H320-4														
H420-4														
H320TC-4		TiCN												
H420TC-4		TiCN												
\emptyset " d ₁ UNC	P TPI	d ₁ mm	l ₁ mm	l ₂ mm	l ₃ mm	d ₂ mm	a mm			ID	ID	ID	ID	
2	56	2.18	45	8		2.8	2.1	2	1.75	● 101221				
4	40	2.84	56	10	18	3.5	2.7	3	2.25	● 101223				
6	32	3.5	56	13	20	4	3	3	2.75	● 101225		● 196046		
8	32	4.16	63	14	21	4.5	3.4	3	3.4	● 101226		● 196047		
10	24	4.82	70	15	25	6	4.9	3	3.8	● 101220		● 196048		
1/4	20	6.35	80	17	30	7	5.5	3	5.1	● 101219		● 196049		
5/16	18	7.93	90	20	35	8	6.2	3	6.5	● 101224		● 143730		
3/8	16	9.52	100	22	39	10	8	3	8	● 101222		● 196050		
7/16	14	11.11	100	19		8	6.2	3	9.3		● 196051		● 196052	
1/2	13	12.7	110	24		9	7	4	10.8		● 101290		● 143731	
5/8	11	15.87	110	30		12	9	4	13.6		● 163741		● 196053	
3/4	10	19.05	125	33		14	11	4	16.6		● 163743		● 196054	

UNC ASME B1.1

PM

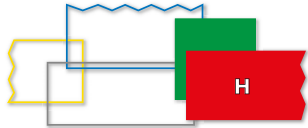
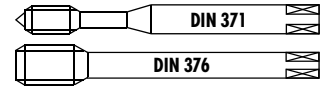

H350-3		15 16 62 64 82
H450-3		15 16 62 64 82
H350TC-3		15 16 24 31 82 83 92 93
H450TC-3		15 16 24 31 82 83 92 93

H350-3	H450-3	H350TC-3	H450TC-3
		NEW	NEW
< 1.5 x D	< 1.5 x D	< 1.5 x D	< 1.5 x D

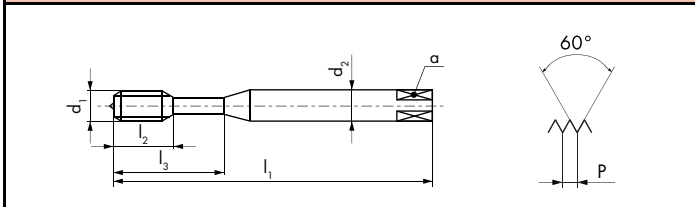

2B	2B	2B	2B

Ø" d ₁ UNC	P TPI	d ₁ mm	l ₁ mm	l ₂ mm	l ₃ mm	d ₂ mm	a mm			ID	ID	ID	ID
2	56	2.18	45	8		2.8	2.1	2	1.75	● 101258			
4	40	2.84	56	5.5	18	3.5	2.7	3	2.25	● 101260			
6	32	3.5	56	6.5	20	4	3	3	2.75	● 101262		● 196040	
8	32	4.16	63	7.5	21	4.5	3.4	3	3.4	● 101263		● 196041	
10	24	4.82	70	9	25	6	4.9	3	3.8	● 101257		● 196042	
1/4	20	6.35	80	11	30	7	5.5	3	5.1	● 101256		● 160585	
5/16	18	7.93	90	12.5	35	8	6.2	3	6.5	● 101261		● 160587	
3/8	16	9.52	100	14	39	10	8	3	8	● 101259		● 162106	
7/16	14	11.11	100	14		8	6.2	3	9.3		● 101330		● 196043
1/2	13	12.7	110	14		9	7	4	10.8		● 101326		● 160586
5/8	11	15.87	110	18		12	9	4	13.6		● 101329		● 196044
3/4	10	19.05	125	21		14	11	4	16.6		● 101328		● 196045
1	8	25.4	160	27		18	14.5	4	22.3		● 101327		

UNC ASME B1.1

PM

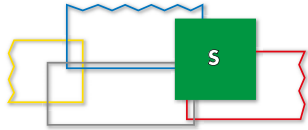
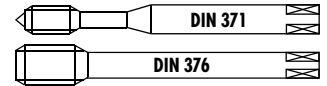

S320VS-4



VS

13 15 16 22 23 24
52

S420VS-4



VS

13 15 16 22 23 24
52

S320VS-4

S420VS-4

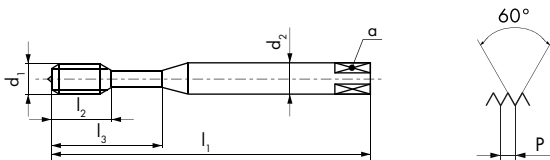

2B

2B

$\emptyset'' d_1$ UNC	P TPI	d_1 mm	l_1 mm	l_2 mm	l_3 mm	d_2 mm	a mm		
6	32	3.5	56	13	20	4	3	3	2.75
8	32	4.16	63	14	21	4.5	3.4	3	3.4
1/4	20	6.35	80	17	30	7	5.5	3	5.1
5/16	18	7.93	90	20	35	8	6.2	3	6.5
3/8	16	9.52	100	22	39	10	8	3	8
1/2	13	12.7	110	24		9	7	4	10.8
5/8	11	15.87	110	30		12	9	4	13.6
3/4	10	19.05	125	33		14	11	4	16.6

ID

ID

● 111587

● 111588

● 111590

● 111591

● 111592

● 111593

● 111594

● 111595

3B
UNC(J)

$\emptyset'' d_1$ UNC	P TPI	d_1 mm	l_1 mm	l_2 mm	l_3 mm	d_2 mm	a mm		
4	40	2.84	56	12	18	3.5	2.7	3	2.3
6	32	3.5	56	13	20	4	3	3	2.8
8	32	4.16	63	14	21	4.5	3.4	3	3.45
1/4	20	6.35	80	17	30	7	5.5	3	5.2
5/16	18	7.93	90	20	35	8	6.2	3	6.7

ID

● 165314

● 165315

● 165316

● 165317

* 143761

UNC ASME B1.1

PM

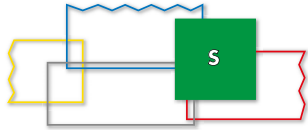
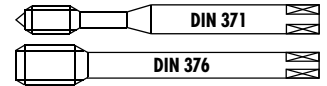

S360VS-3 13 15 16 22 23 24
52

S460VS-3 13 15 16 22 23 24
52

S360VS-3 **S460VS-3**

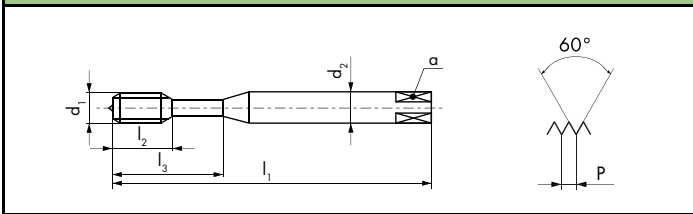
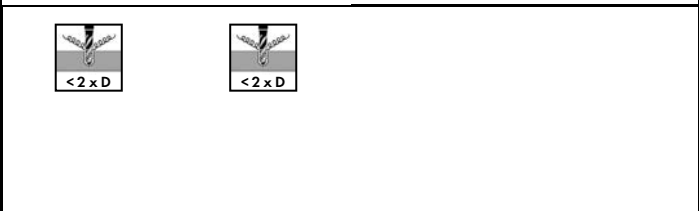

2B **2B**

\emptyset " d ₁ UNC	P TPI	d ₁ mm	l ₁ mm	l ₂ mm	l ₃ mm	d ₂ mm	a mm			ID	ID
6	32	3.5	56	6.5	20	4	3	3	2.75	● 111530	
8	32	4.16	63	7.5	21	4.5	3.4	3	3.4	● 111531	
1/4	20	6.35	80	11	30	7	5.5	3	5.1	● 111533	
5/16	18	7.93	90	12.5	35	8	6.2	3	6.5	● 111534	
3/8	16	9.52	100	14	39	10	8	3	8	● 111535	
1/2	13	12.7	110	14		9	7	4	10.8		● 111537

aero

										SA320-4	SA350-3	TL320VS-4	TL351VS-3
<p>SA320-4 15 16 52 64</p> <p>SA350-3 15 16 52 64</p>													
<p>TL320VS-4 VS 41 42</p> <p>TL351VS-3 R15 VS 41 42</p>													
\emptyset'' d ₁ UNC	P TPI	d ₁ mm	l ₁ mm	l ₂ mm	l ₃ mm	d ₂ mm	a mm			ID	ID	ID	ID
4	40	2.84	56	12		3.5	2.7	3		● 147271	● 149003		● 152018
5	40	3.17	56	12		3.5	2.7	3				* 152023	* 152024
6	32	3.5	56	13		4	3	3		● 149055	● 149057	* 152027	● 152028
8	32	4.16	63	14		4.5	3.4	3		● 149093	● 149095		● 152037
10	24	4.82	70	15		6	4.9	3		● 149125	* 149127		
1/4	20	6.35	80	15	23	7	5.5	3		● 149222	● 149224		● 127972
5/16	18	7.93	90	18	29	8	6.2	3		● 149269	● 149271		● 152068
3/8	16	9.52	100	20	33	10	8	3		● 149346	● 149348	* 152084	● 152085
\emptyset'' d ₁ UNC	P TPI	d ₁ mm	l ₁ mm	l ₂ mm	l ₃ mm	d ₂ mm	a mm			ID	ID	ID	ID
4	40	2.84	56	12		3.5	2.7	3		● 149005	● 149007	* 148804	● 150194
6	32	3.5	56	13		4	3	3		● 149059	● 149061	* 152029	● 150210
8	32	4.16	63	14		4.5	3.4	3		● 149097	● 149099		● 152039
10	24	4.82	70	15		6	4.9	3					* 152045
1/4	20	6.35	80	15	23	7	5.5	3		● 149226	● 149228	* 152063	● 152064
5/16	18	7.93	90	18	29	8	6.2	3		● 149273	● 149275	* 152069	● 152070
3/8	16	9.52	100	20	33	10	8	3		● 149350	● 149352		● 152087

UNC ASME B1.1

PM

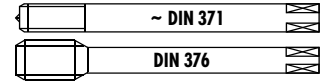

aero

SA420-4



15 16 52 64

SA450-3



15 16 52 64

SA390-3



16 53

SA420-4

SA450-3

SA390-3

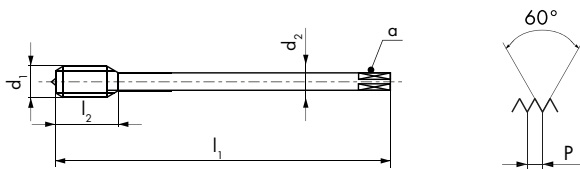

2B

2B

Ø" d ₁ UNC	P TPI	d ₁ mm	l ₁ mm	l ₂ mm	d ₂ mm	a mm		
1/2	13	12.7	110	24	9	7	4	10.8
5/8	11	15.87	110	30	12	9	4	13.6

ID

ID

● 152247

● 152252

● 152249

● 152254

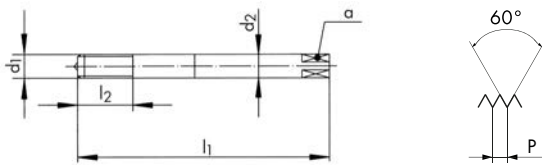

3B
UNC(J)

Ø" d ₁ UNC	P TPI	d ₁ mm	l ₁ mm	l ₂ mm	d ₂ mm	a mm		
4	40	2.84	56	12	3.5	2.7	3	2.3
6	32	3.5	56	13	4	3	3	2.8
8	32	4.16	63	14	4.5	3.4	3	3.45
10	24	4.82	70	15	6	4.9	3	3.9
1/4	20	6.35	80	20	7	5.5	3	5.2
5/16	18	7.93	90	25	8	6.2	3	6.7
3/8	16	9.52	100	30	10	8	3	8.1

ID

● 149652

● 149666

● 149677

● 149685

● 149713

● 149726

● 149747



PM

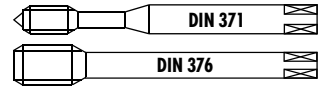

QTAP

Q320VS-4



Q420VS-4



Q323VS-4



Q423VS-4



- 11 12 13 14
- 15 21 22 23
- 24 31 32 51
- 52 61 62 63
- 64 71 72 73
- 74 81 82 83
- 91 92 94

Q320VS-4

Q420VS-4

Q323VS-4

Q423VS-4



NEW



NEW



NEW



NEW

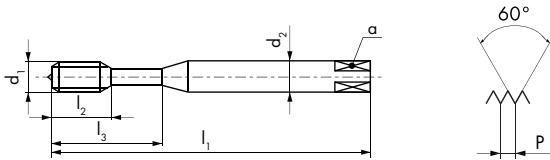

2B



2B



2B



2B

Ø" d ₁ UNC	P TPI	d ₁ mm	l ₁ mm	l ₂ mm	l ₃ mm	d ₂ mm	a mm		
6	32	3.5	56	13	20	4	3	3	2.75
8	32	4.16	63	14	21	4.5	3.4	3	3.4
10	24	4.82	70	15	25	6	4.9	3	3.8
1/4	20	6.35	80	17	30	7	5.5	3	5.1
5/16	18	7.93	90	20	35	8	6.2	3	6.5
3/8	16	9.52	100	22	39	10	8	3	8
1/2	13	12.7	110	24		9	7	3	10.8
5/8	11	15.87	110	30		12	9	3	13.6
3/4	10	19.05	125	33		14	11	4	16.6
7/8	9	22.22	140	36		18	14.5	4	19.5
1	8	25.4	160	39		18	14.5	4	22.3

ID

ID

ID

ID

● 196275

● 196320

● 196276

● 196321

● 196277

● 196322

● 196278

● 196323

● 196279

● 196324

● 196280

● 196325

● 196281

● 196326

● 196282

● 196327

● 196283

● 196328

● 196284

● 196329

● 196285

● 196330



≤ Ø 16 > Ø 16

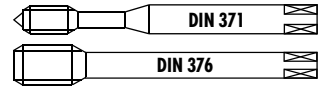
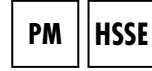

QTAP

Q360VS-3



Q460VS-3



Q363VS-3



Q463VS-3

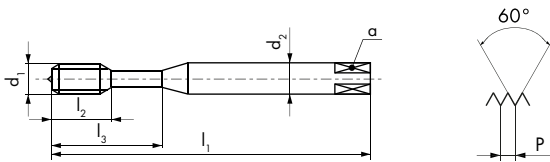

Q360VS-3

Q460VS-3

Q363VS-3

Q463VS-3



NEW



NEW



NEW



NEW



< 2.5 x D



< 2.5 x D



< 2.5 x D



< 2.5 x D



2.5 x P

2B



2.5 x P

2B



2.5 x P

2B



2.5 x P

2B

Ø" d ₁ UNC	P TPI	d ₁ mm	l ₁ mm	l ₂ mm	l ₃ mm	d ₂ mm	a mm		
6	32	3.5	56	6.5	20	4	3	3	2.75
8	32	4.16	63	7.5	21	4.5	3.4	3	3.4
10	24	4.82	70	9	25	6	4.9	3	3.8
1/4	20	6.35	80	11	30	7	5.5	3	5.1
5/16	18	7.93	90	12.5	35	8	6.2	3	6.5
3/8	16	9.52	100	14	39	10	8	3	8
7/16	14	11.11	100	14		8	6.2	3	9.3
1/2	13	12.7	110	14		9	7	3	10.8
5/8	11	15.87	110	18		12	9	3	13.6
3/4	10	19.05	125	21		14	11	3	16.6
7/8	9	22.22	140	24		18	14.5	3	19.5
1	8	25.4	160	27		18	14.5	4	22.3

ID

ID

ID

ID

● 196286

● 196331

● 196287

● 196332

● 196288

● 196333

● 196289

● 197622

● 196290

● 197623

● 196291

● 197624

● 196292 ● 197625

● 196293 ● 197626

● 196294 ● 197627

● 196295 ● 197628

● 196296 ● 197629

● 196297 ● 197630



Uniquement pour taraudage synchrone
Nur für Synchrobearbeitung
Only for rigid tapping
Solo per mescolatura sincrona
Solo para resacado sincronizado
Только для rigid tapping

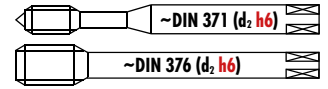

RTS

Rigid Tapping Synchro

RTS320VS-4		VS	11 12 13 14 15 21 31 32 51 61 63 64 72 73 74 81 82 83 91 92 94
RTS420VS-4		VS	11 12 13 14 15 21 31 32 51 61 63 64 72 73 74 81 82 83 91 92 94
RTS362VS-3		VS	11 12 13 14 15 21 31 32 51 61 63 64 72 73 74 81 82 83 91 92 94
RTS462VS-3		VS	11 12 13 14 15 21 31 32 51 61 63 64 72 73 74 81 82 83 91 92 94

RTS320VS-4	RTS420VS-4	RTS362VS-3	RTS462VS-3
------------	------------	------------	------------



		< 2.5 x D	< 2.5 x D

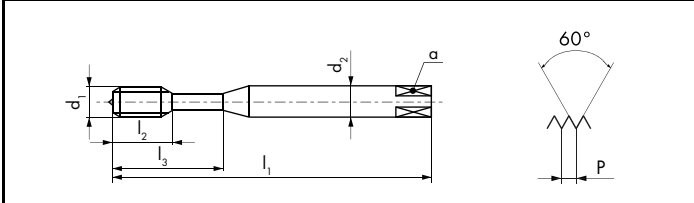

2BX	2BX	2BX	2BX

Ø" d ₁ UNC	P TPI	d ₁ mm	l ₁ mm	l ₂ mm	l ₃ mm	d ₂ h ₆ mm	a mm			
6	32	3.5	56	6.5	20	4 (h9)	3	3	2.75	● 157395
8	32	4.16	63	7.5	21	4.5(h9)	3.4	3	3.4	● 157396
10	24	4.82	70	9	25	6	4.9	3	3.8	● 157397
1/4	20	6.35	80	11	30	* 6	* 4.9	3	5.1	● 157398
5/16	18	7.93	90	12.5	35	8	6.2	3	6.5	● 157399
3/8	16	9.52	100	14	39	10	8	3	8	● 157400
1/2	13	12.7	110	14		* 10	* 8	3	10.8	● 157401

ID	ID	ID	ID
● 157395		● 157402	
● 157396		● 157403	
● 157397		● 157404	
● 157398		● 157405	
● 157399		● 157406	
● 157400		● 157407	
	● 157401		● 157408

* Norme DC / * DC Norm/ * Norma DC



sur demande
auf Anfrage
on request
su richiesta
sobre pedido
no zapyty

UNC ASME B1.1

≤ Ø 2.8 > Ø 2.8

PM HSS

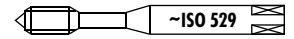

										N1110-1	N1110-2	N1110-3	N1110-S
Ø" d ₁ UNC	P TPI	d ₁ mm	l ₁ mm	l ₂ mm	l ₃ mm	d ₂ mm	a mm			ID	ID	ID	ID
2	56	2.18	45	9.5		2.8	2.1	3	1.75	● 102799	● 102885	● 102998	● 111067
3	48	2.51	45	9.5		2.8	2.1	3	2	★ 102800	★ 102886	★ 102999	★ 111068
4	40	2.84	48	11	18	3.15	2.5	3	2.25	● 102802	● 102888	● 103001	● 111070
5	40	3.17	48	11	18	3.15	2.5	3	2.55			● 103002	
6	32	3.5	50	13	20	3.55	2.8	3	2.75	● 102805	● 102891	● 103004	● 111073
8	32	4.16	53	13	21	4.5	3.55	3	3.4	● 102806	● 102892	● 103005	● 111074
10	24	4.82	58	16	25	5	4	3	3.8	● 102797	● 102883	● 102996	● 111065
1/4	20	6.35	66	19	30	6.3	5	3	5.1	● 102796	● 102882	● 102995	● 111064
5/16	18	7.93	72	22	35	8	6.3	3	6.5	● 102804	● 102890	● 103003	● 111072
3/8	16	9.52	80	24	39	10	8	3	8	● 102801	● 102887	● 103000	● 111069

UNC ASME B1.1

HSS

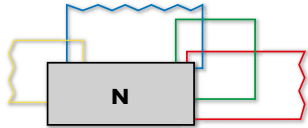
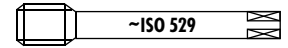

N1210-1		
N1210-2		
N1210-3		
		31 62 73 74 91
N1210-S		

N1210-1	N1210-2	N1210-3	N1210-S
---------	---------	---------	---------



		< 1.5 x D	< 2.5 x D

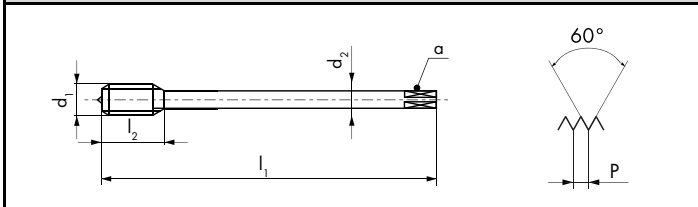





















		2B	2B

$\varnothing'' d_1$ UNC	P TPI	d_1 mm	l_1 mm	l_2 mm	d_2 mm	a mm			ID	ID	ID	ID
7/16	14	11.11	85	22	8	6.3	3	9.3	● 103392	● 103466	● 103606	● 111236
1/2	13	12.7	89	24	9	7.1	3	10.8	● 103387	● 103461	● 103601	● 111229
5/8	11	15.87	102	32	12.5	10	3	13.6	● 103391	● 103465	● 103605	● 111235
3/4	10	19.05	112	33	14	11.2	3	16.6	● 103390	● 103464	● 103604	● 111234
1	8	25.4	130	45	18	14	4	22.3	● 103388	● 103462	● 103602	● 111230

UNF, UNEF UNS, UN



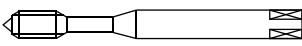
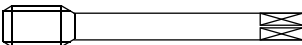







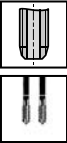

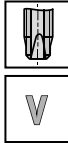
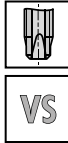
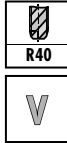
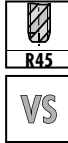

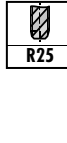







Répertoire — Tarauls à machine ASME B1.1
Rubrica — Maschi a macchina ASME B1.1

		N						
Caractéristiques Caratteristiche				 V	 TiN	 R40	 R40 V	 R40 TiN
					 NEW			 NEW
Genre de trou Tipo di foro								
		N310-3	N320-3 N320-4	N320V-4	N320TN-4	N360-3	N360V-3	N360TN-3
DIN longue DIN lungo	DIN 371	176	176	176	176	178	178	178
ISO courte ISO corto	ISO 529							
Tolérance Tolleranza	UNF 2B	176	176	176	176	178	178	178
Tolérance Tolleranza	UNF(J) 3B		176			178		
Tolérance Tolleranza	UNEF 2B							
Tolérance Tolleranza	UNS 2B							
Tolérance Tolleranza	UN 2B							
		N410-3	N420-4	N420V-4	N420TN-4	N460-3	N460V-3	N460TN-3
DIN longue DIN lungo	DIN 374/~DIN 376	177 / 199	177	177	177	179 / 199	179 / 199	179
ISO courte ISO corto	ISO 529							
Tolérance Tolleranza	UNF 2B	177	177	177	177	179	179	179
Tolérance Tolleranza	UNF(J) 3B		177			179		
Tolérance Tolleranza	UNEF 2B							
Tolérance Tolleranza	UNS 2B	199				199	199	
Tolérance Tolleranza	UN 2B					199	199	



















UNF, UNEF

Répertoire — Tarands à machine et à main ASME B1.1

Rubrica — Maschi a macchina e a mano ASME B1.1

N		Z				H		
		 V	 VS	 R40 V	 R45 VS		 TiCN	 R25
			 NEW				 NEW	
								
N1110 -1 -3 -S	N1120-4	Z320V-4	Z320VS-4	Z360V-3	Z370VS-3	H320-4	H320TC-4	H350-3
196 / 198	198	180	180	181	182	184	184	185
196		180	180	181	182	184	184	185
198	198				182			
N1210 -1 -3 -S	N1220-4	Z420V-4	Z420VS-4	Z460V-3	Z470VS-3	H420-4	H420TC-4	H450-3
197 / 198	198	180	180	181	182	184	184	185
197		180	180	181	182	184	184	185
198	198							

		H	S		SA		TL	
Caractéristiques Caratteristiche		 R25 TTCN	 VS	 R35 VS		 R15	 R10 VS	
		 NEW						
Genre de trou Tipo di foro								
		H350TC-3	S320VS-4	S360VS-3	SA320-4	SA350-3	SA390-3	TL351VS-3
<i>DIN longue</i> DIN lungo	DIN 371	185	186	186	188	188	190	188
<i>ISO courte</i> ISO corto	ISO 529							
<i>Tolérance</i> Tolleranza	UNF 2B	185			188	188		188
<i>Tolérance</i> Tolleranza	UNF(J) 3B		186	186	188	188	190	188
<i>Tolérance</i> Tolleranza	UNEF 2B							
<i>Tolérance</i> Tolleranza	UNS 2B							
<i>Tolérance</i> Tolleranza	UN 2B							
		H450TC-3	S420VS-4	S460VS-3	SA420-4	SA450-3		TL451VS-3
<i>DIN longue</i> DIN lungo	DIN 374/~DIN 376	185	186	186	189	189		189
<i>ISO courte</i> ISO corto	ISO 529							
<i>Tolérance</i> Tolleranza	UNF 2B	185			189	189		
<i>Tolérance</i> Tolleranza	UNF(J) 3B		186	186	189	189		189
<i>Tolérance</i> Tolleranza	UNEF 2B							
<i>Tolérance</i> Tolleranza	UNS 2B							
<i>Tolérance</i> Tolleranza	UN 2B							

QTAP				RTS	
					
VS	VS	VS	VS	VS	VS
					
NEW	NEW	NEW	NEW		
					
Q320VS-4	Q323VS-4	Q360VS-3	Q363VS-3	RTS320VS-4	RTS362VS-3
192	192	193	193	194	194
192	192	193	193	194	194
Q420VS-4	Q423VS-4	Q460VS-3	Q463VS-3	RTS420VS-4	RTS462VS-3
192	192	193	193	194	194
192	192	193	193	194	194

UNF ASME B1.1

≤ Ø 2.8 > Ø 2.8

PM HSSE

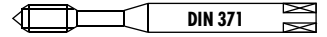

										N310-3	N320-4	N320V-4	N320TN-4
N310-3													
N320-4													
N320V-4													
N320TN-4													
Ø" d ₁ UNF	P TPI	d ₁ mm	l ₁ mm	l ₂ mm	l ₃ mm	d ₂ mm	a mm			ID	ID	ID	ID
* 0	80	1.52	40	7		2.5	2.1	2	1.2		● 101475		
* 2	64	2.18	45	9		2.8	2.1	2	1.8		● 101477		
4	48	2.84	56	12	18	3.5	2.7	3	2.35		● 128847		
5	44	3.17	56	12	18	3.5	2.7	3	2.6		● 142764		
6	40	3.5	56	13	20	4	3	3	2.9		● 101519	● 142765	
8	36	4.16	63	14	21	4.5	3.4	3	3.5		● 101520		
10	32	4.82	70	15	25	6	4.9	3	4.05		● 101517	● 142766	● 196014
12	28	5.48	80	17	30	6	4.9	3	4.6		● 101518		
1/4	28	6.35	80	17	30	7	5.5	3	5.5	● 101453	● 101516	● 142767	● 158791
Ø" d ₁ UNF	P TPI	d ₁ mm	l ₁ mm	l ₂ mm	l ₃ mm	d ₂ mm	a mm			ID			
10	32	4.82	70	15	25	6	4.9	3	4.15	● 135506			
1/4	28	6.35	80	17	30	7	5.5	3	5.55	● 155323			
										*N320-3			

UNF ASME B1.1

HSSE

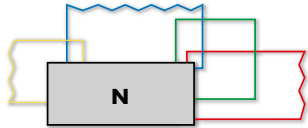

N410-3		31 62 73 74 91
N420-4		62 63 64 72 73 74 81 91
N420V-4	V	11 12 31 32
N420TN-4	TiN	11 12 13 14 32

N410-3	N420-4	N420V-4	N420TN-4
			NEW
< 1.5 x D			

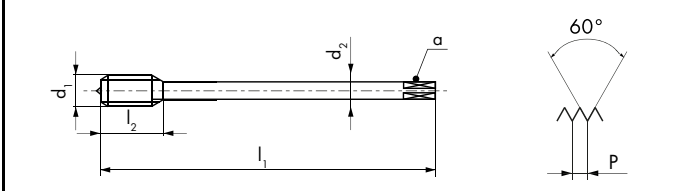

2.5 x P	4 x P	4 x P	4 x P
2B	2B	2B	2B

Ø" d ₁ UNF	P TPI	d ₁ mm	l ₁ mm	l ₂ mm	d ₂ mm	a mm		
5/16	24	7.93	90	20	6	4.9	3	6.9
3/8	24	9.52	100	22	7	5.5	3	8.5
7/16	20	11.11	100	19	8	6.2	3	9.8
1/2	20	12.7	100	24	9	7	3	11.4
9/16	18	14.28	100	24	11	9	3	12.9
5/8	18	15.87	100	26	12	9	3	14.5
3/4	16	19.05	125	33	14	11	4	17.5
7/8	14	22.22	140	36	18	14.5	4	20.4
1	12	25.4	160	39	18	14.5	4	23.3
1 1/8	12	28.57	180	39	22	18	4	26.5
1 1/4	12	31.75	180	39	22	18	4	29.7
1 3/8	12	34.92	200	36	28	22	4	32.8
1 1/2	12	38.1	200	41	32	24	4	36

ID	ID	ID	ID
● 102004	● 102223	● 142774	● 196015
● 102003	● 102222	● 142775	● 196016
● 102006	● 102225	● 142776	● 196017
● 102000	● 102219	● 142777	● 196018
	● 102227		
● 102005	● 102224	● 142778	● 196019
● 102002	● 102221	● 142779	● 185919
	● 102226		
	● 102220	● 142780	
	● 142773		
	● 102218		
	● 105137		
	● 105138		

									3B UNF(J)
--	--	--	--	--	--	--	--	--	---------------------

Ø" d ₁ UNF	P TPI	d ₁ mm	l ₁ mm	l ₂ mm	d ₂ mm	a mm		
5/16	24	7.93	90	20	6	4.9	3	7
3/8	24	9.52	100	22	7	5.5	3	8.6
7/16	20	11.11	100	19	8	6.2	3	10
1/2	20	12.7	100	24	9	7	3	11.55

ID
● 155328
● 155326
● 155330
● 155321

UNF ASME B1.1

HSSE

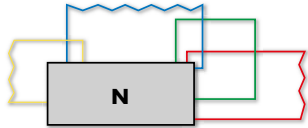
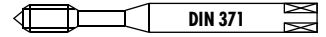

N360-3		63 72 73 74 81 91
N360V-3		11 12 32
N360TN-3		11 12 13 14 32

N360-3	N360V-3	N360TN-3	
		NEW	

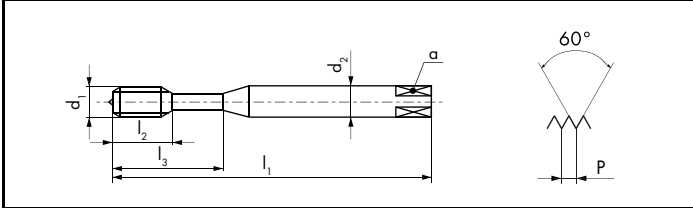

2B	2B	2B

\emptyset " d_1 UNF	P TPI	d_1 mm	l_1 mm	l_2 mm	l_3 mm	d_2 mm	a mm			ID	ID	ID
6	40	3.5	56	6.5	20	4	3	3	2.9	● 101686		
10	32	4.82	70	9	25	6	4.9	3	4.05	● 101682	● 101730	● 196009
12	28	5.48	80	11	30	6	4.9	3	4.6	● 101683		
1/4	28	6.35	80	11	30	7	5.5	3	5.5	● 101681	● 101729	● 146137
5/16	24	7.93	90	12.5	35	8	6.2	3	6.9	● 101685	● 101732	● 196010
3/8	24	9.52	100	14	39	10	8	3	8.5	● 101684	● 101731	● 196011

										3B UNF(J)		
--	--	--	--	--	--	--	--	--	--	---------------------	--	--

\emptyset " d_1 UNF	P TPI	d_1 mm	l_1 mm	l_2 mm	l_3 mm	d_2 mm	a mm			ID
10	32	4.82	70	9	25	6	4.9	3	4.15	● 155325
1/4	28	6.35	80	11	30	7	5.5	3	5.55	● 155324
5/16	24	7.93	90	12.5	35	8	6.2	3	7	● 155329
3/8	24	9.52	100	14	39	10	8	3	8.6	● 155327

UNF ASME B1.1

HSSE

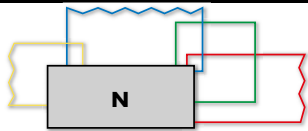

N460-3		
N460V-3		
N460TN-3		

N460-3	N460V-3	N460TN-3

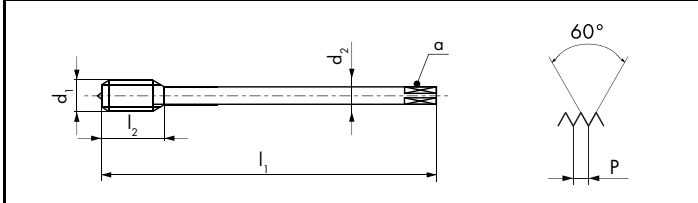

2B	2B	2B

Ø" d ₁ UNF	P TPI	d ₁ mm	l ₁ mm	l ₂ mm	d ₂ mm	a mm		
7/16	20	11.11	100	14	8	6.2	3	9.8
1/2	20	12.7	100	14	9	7	3	11.4
9/16	18	14.28	100	14	11	9	3	12.9
5/8	18	15.87	100	14	12	9	3	14.5
3/4	16	19.05	125	18	14	11	4	17.5
7/8	14	22.22	140	20	18	14.5	4	20.4
1	12	25.4	160	27	18	14.5	4	23.3
1 1/8	12	28.57	180	24	22	18	4	26.5
1 1/4	12	31.75	180	24	22	18	4	29.7
1 1/2	12	38.1	200	30	32	24	5	36

ID	ID	ID
● 102434	● 142781	● 158885
● 102430	● 102503	● 196012
● 102436	● 143422	
● 102433	● 143097	● 196013
● 102432	● 102505	● 142568
● 102435	● 144714	
● 102431	● 102504	
● 102429	● 144414	
● 102428	● 151709	
● 102427	● 148793	

3B UNF(J)

Ø" d ₁ UNF	P TPI	d ₁ mm	l ₁ mm	l ₂ mm	d ₂ mm	a mm		
7/16	20	11.11	100	14	8	6.2	3	10
1/2	20	12.7	100	14	9	7	3	11.55

ID
● 155331
● 155322

UNF ASME B1.1

PM

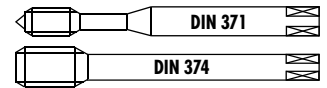

										Z320V-4	Z420V-4	Z320VS-4	Z420VS-4
Z320V-4		V	11	12	13	21	32						
Z420V-4		V	11	12	13	21	32						
Z320VS-4		VS	11	12	13	14	21	22	NEW				
Z420VS-4		VS	11	12	13	14	21	22	NEW				
\emptyset " d ₁ UNF	P TPI	d ₁ mm	l ₁ mm	l ₂ mm	l ₃ mm	d ₂ mm	a mm			ID	ID	ID	ID
10	32	4.82	70	15	25	6	4.9	3		● 142783		● 128685	
1/4	28	6.35	80	17	30	7	5.5	3		● 142784		● 128596	
5/16	24	7.93	90	20	35	8	6.2	3		● 142785		● 128869	
3/8	24	9.52	100	22	39	10	8	3		● 142786		● 128814	
7/16	20	11.11	100	19		8	6.2	3			● 142787		● 128960
1/2	20	12.7	100	24		9	7	3			● 142788		● 128556
5/8	18	15.87	100	26		12	9	3					● 196031
3/4	16	19.05	125	33		14	11	4					● 196032

UNF ASME B1.1

HSSE

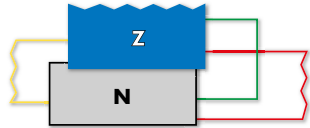
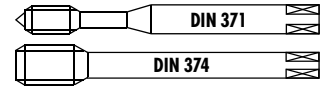

Z360V-3					
Z460V-3					

Z360V-3	Z460V-3		

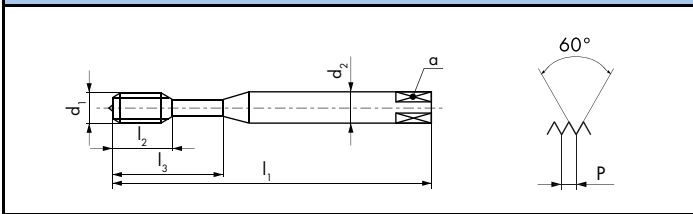

2B	2B

Ø" d ₁ UNF	P TPI	d ₁ mm	l ₁ mm	l ₂ mm	l ₃ mm	d ₂ mm	a mm			ID	ID
10	32	4.82	70	9	25	6	4.9	3	4.05	● 104680	
1/4	28	6.35	80	11	30	7	5.5	3	5.5	● 104679	
5/16	24	7.93	90	12.5	35	8	6.2	3	6.9	● 104682	
3/8	24	9.52	100	14	39	10	8	3	8.5	● 104681	
7/16	20	11.11	100	14		8	6.2	3	9.8		● 104741
1/2	20	12.7	100	14		9	7	3	11.4		● 104738
5/8	18	15.87	100	14		12	9	3	14.5		● 104740
3/4	16	19.05	125	18		14	11	4	17.5		● 104739

UNF ASME B1.1

PM

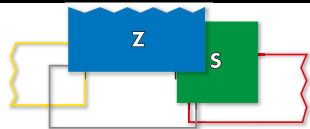
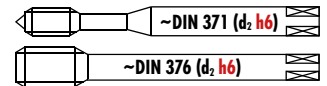

Z370VS-3 Z470VS-3



Z370VS-3 R45 VS CLASSIC

Z470VS-3 R45 VS CLASSIC

Z370VS-3 R45 VS SYNCHRO

Z470VS-3 R45 VS SYNCHRO

14 15 21 22 23
24 51 61 94

13 14 15 21 22
23 24 51 52

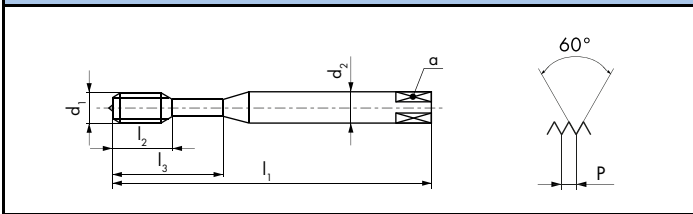

2.5 x P 2.5 x P

2BX **2BX**

Ø" d ₁ UNF	P TPI	d ₁ mm	l ₁ mm	l ₂ mm	l ₃ mm	d ₂ h ₆ mm	a mm		
10	32	4.82	70	9	25	6	4.9	3	4.05
1/4	28	6.35	80	11	30	* 6	* 4.9	3	5.5
5/16	24	7.93	90	12.5	35	8	6.2	3	6.9
3/8	24	9.52	100	14	39	10	8	3	8.5
7/16	20	11.11	100	14		8	6.2	3	9.8
1/2	20	12.7	110	14		* 10	* 8	4	11.4
5/8	18	15.87	110	18		12	9	4	14.5
3/4	16	19.05	125	21		14	11	4	17.5

ID	ID
● 166136	
● 166135	
● 166134	
● 166133	
	● 166138
	● 166137
	● 196029
	● 196030

* Norme DC / * DC Norm/ * Norma DC

3B UNF(J)

Ø" d ₁ UNF	P TPI	d ₁ mm	l ₁ mm	l ₂ mm	l ₃ mm	d ₂ h ₆ mm	a mm		UNF
10	32	4.82	70	9	25	6	4.9	3	4.15
1/4	28	6.35	80	11	30	* 6	* 4.9	3	5.55
5/16	24	7.93	90	12.5	35	8	6.2	3	7
3/8	24	9.52	100	14	39	10	8	3	8.6

ID
● 165121
● 165122
● 165123
● 165124

* Norme DC / * DC Norm/ * Norma DC

MJ, UNJC, UNJF

*Nos tarauds machine avec rayon sur le diamètre extérieur sont répertoriés dans un chapitre séparé commençant à la **page 44**.*

I nostri maschi a macchina con raggio sul diametro esterno sono raggruppati in un capitolo separato a partire da **pagina 44.**

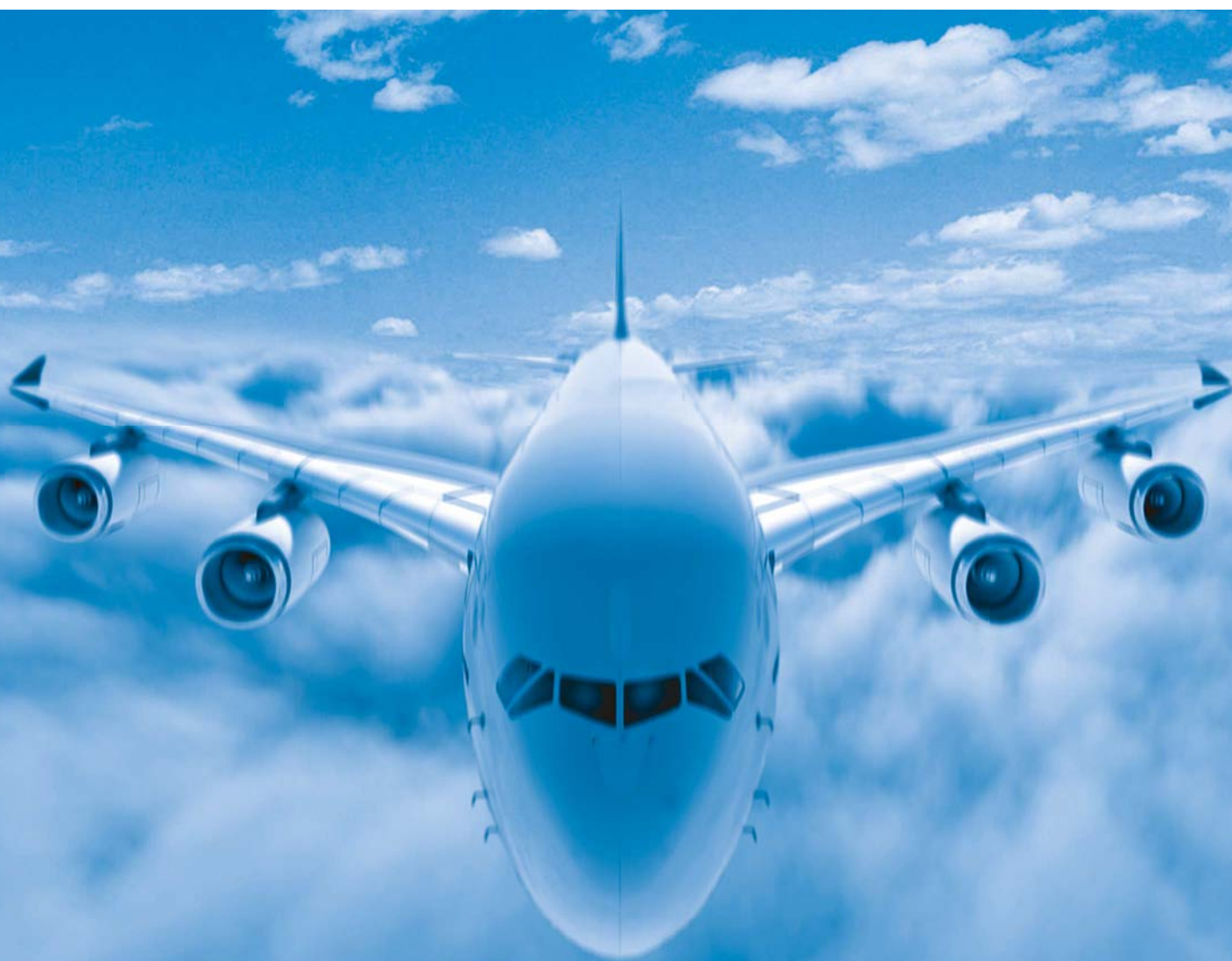
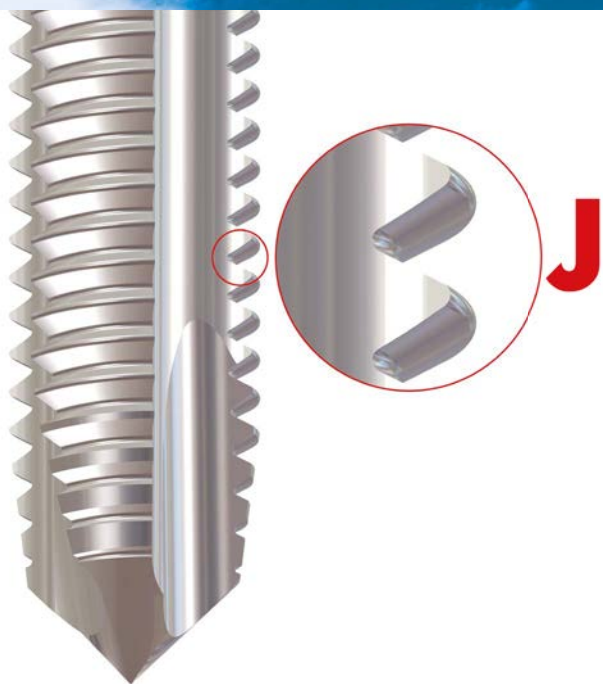

UNF ASME B1.1

PM

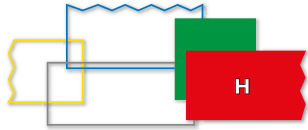
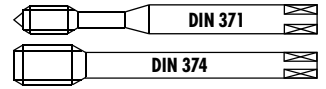

H320-4		15 16 62 64 82
H420-4		15 16 62 64 82
H320TC-4		15 16 24 31 82 83 92 93
H420TC-4		15 16 24 31 82 83 92 93

H320-4	H420-4	H320TC-4	H420TC-4
--------	--------	----------	----------

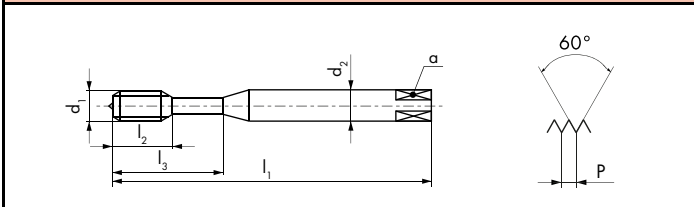
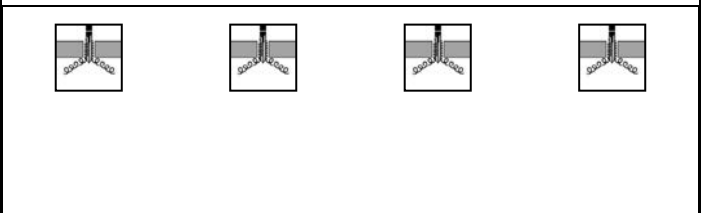

2B	2B	2B	2B

Ø" d ₁ UNF	P TPI	d ₁ mm	l ₁ mm	l ₂ mm	l ₃ mm	d ₂ mm	a mm			ID	ID	ID	ID
10	32	4.82	70	15	25	6	4.9	3	4.05	● 101228		● 196060	
1/4	28	6.35	80	17	30	7	5.5	3	5.5	● 101227		● 142613	
5/16	24	7.93	90	20	35	8	6.2	3	6.9	● 105139		● 196061	
3/8	24	9.52	100	22	39	10	8	3	8.5	● 101229		● 196062	
7/16	20	11.11	100	19		8	6.2	3	9.8		● 147253		● 196063
1/2	20	12.7	100	24		9	7	4	11.4		● 101291		● 196064
5/8	18	15.87	100	26		12	9	4	14.5		● 101293		● 196065
3/4	16	19.05	125	33		14	11	4	17.5		● 101292		● 196066

UNF ASME B1.1

PM

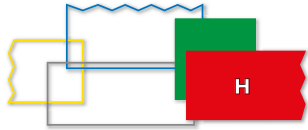
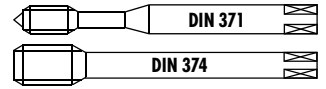

H350-3		15 16 62 64 82
H450-3		15 16 62 64 82
H350TC-3		15 16 24 31 82 83 92 93
H450TC-3		15 16 24 31 82 83 92 93

H350-3	H450-3	H350TC-3	H450TC-3
		NEW	NEW
< 1.5 x D	< 1.5 x D	< 1.5 x D	< 1.5 x D

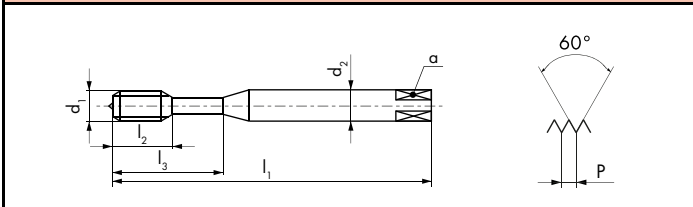

2B	2B	2B	2B

Ø" d ₁ UNF	P TPI	d ₁ mm	l ₁ mm	l ₂ mm	l ₃ mm	d ₂ mm	a mm			ID	ID	ID	ID
10	32	4.82	70	9	25	6	4.9	3	4.05	● 101265		● 196055	
1/4	28	6.35	80	11	30	7	5.5	3	5.5	● 101264		● 146714	
5/16	24	7.93	90	12.5	35	8	6.2	3	6.9	● 101267		● 196056	
3/8	24	9.52	100	14	39	10	8	3	8.5	● 101266		● 196057	
7/16	20	11.11	100	14		8	6.2	3	9.8		● 101334		● 196058
1/2	20	12.7	100	14		9	7	4	11.4		● 101331		● 196059
5/8	18	15.87	100	14		12	9	4	14.5		● 101333		● 174297
3/4	16	19.05	125	18		14	11	4	17.5		● 101332		● 158882

UNF ASME B1.1

PM

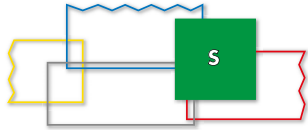
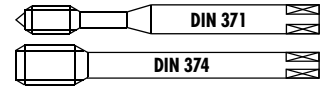

S320VS-4		VS	13 15 16 22 23 24 52
S420VS-4		VS	13 15 16 22 23 24 52
S360VS-3		VS	13 15 16 22 23 24 52
S460VS-3		VS	13 15 16 22 23 24 52

S320VS-4	S420VS-4	S360VS-3	S460VS-3

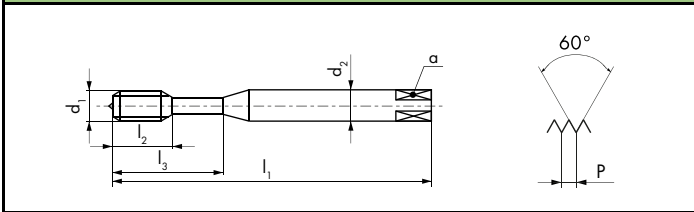

3B UNF(J)	3B UNF(J)		

$\emptyset'' d_1$ UNF	P TPI	d_1 mm	l_1 mm	l_2 mm	l_3 mm	d_2 mm	a mm			ID	ID
10	32	4.82	70	15	25	6	4.9	3	4.15	● 111814	
1/4	28	6.35	80	17	30	7	5.5	3	5.55	● 111813	
5/16	24	7.93	90	20	35	8	6.2	3	7	● 111816	
3/8	24	9.52	100	22	39	10	8	3	8.6	● 111818	
7/16	20	11.11	100	22		8	6.2	3	10		● 111837

$\emptyset'' d_1$ UNF	P TPI	d_1 mm	l_1 mm	l_2 mm	l_3 mm	d_2 mm	a mm			ID	ID
10	32	4.82	70	9	25	6	4.9	3	4.15		● 111815
1/4	28	6.35	80	11	30	7	5.5	3	5.55		● 111820
5/16	24	7.93	90	12.5	35	8	6.2	3	7		● 111817
3/8	24	9.52	100	14	39	10	8	3	8.6		● 111819
7/16	20	11.11	100	14		8	6.2	3	10		● 111833



S | **RESPECTING
THREADING**



aero

SA320-4



15 16 52 64

SA350-3



15 16 52 64

TL351VS-3



41 42

SA320-4

SA350-3

TL351VS-3



< 1.5 x D

< 2 x D



< 2 x D

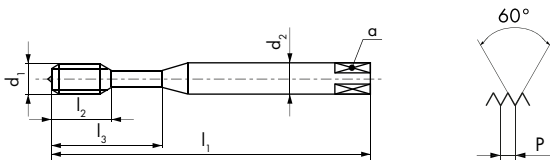

4 x P

2.5 x P

2.5 x P

2B

2B

2B

Ø" d ₁ UNF	P TPI	d ₁ mm	l ₁ mm	l ₂ mm	l ₃ mm	d ₂ mm	a mm		
10	32	4.82	70	15		6	4.9	3	4.05
1/4	28	6.35	80	15	23	7	5.5	3	5.5
5/16	24	7.93	90	18	29	8	6.2	3	6.9
3/8	24	9.52	100	20	33	10	8	3	8.5

ID

ID

ID

● 149133	● 149135	● 152047
● 149230	● 149232	● 152066
● 149277	● 149279	● 152072
● 149339	● 149341	● 152083

3B
UNF(J)

3B
UNF(J)

3B
UNF(J)

Ø" d ₁ UNF	P TPI	d ₁ mm	l ₁ mm	l ₂ mm	l ₃ mm	d ₂ mm	a mm		
4	48	2.84	56	12		3.5	2.7	3	2.35
10	32	4.82	70	15		6	4.9	3	4.15
1/4	28	6.35	80	15	23	7	5.5	3	5.55
5/16	24	7.93	90	18	29	8	6.2	3	7
3/8	24	9.52	100	20	33	10	8	3	8.6

ID

ID

ID

	● 149015	
● 146098	● 149138	● 148004
● 146404	● 149235	● 148012
● 146393	● 149282	● 148016
● 147165	● 149344	● 148023

UNF ASME B1.1

PM

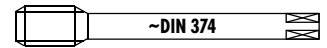

aero

SA420-4



15 16 52 64

SA450-3



15 16 52 64

TL451VS-3



41 42

SA420-4

SA450-3

TL451VS-3



2B

2B

2B

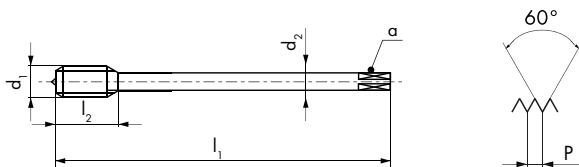

$\emptyset'' d_1$ UNF	P TPI	d_1 mm	l_1 mm	l_2 mm	d_2 mm	a mm		
7/16	20	11.11	100	22	8	6.2	* 4	9.8
1/2	20	12.7	100	24	9	7	4	11.4
5/8	18	15.87	100	26	12	9	4	14.5

ID	ID
● 152286	● 152290
● 152287	● 152291
★ 152289	

$\emptyset'' d_1$ UNF	P TPI	d_1 mm	l_1 mm	l_2 mm	d_2 mm	a mm		
7/16	20	11.11	100	22	8	6.2	* 4	10
1/2	20	12.7	100	24	9	7	4	11.55
9/16	18	14.28	100	24	11	9	4	13.05
5/8	18	15.87	100	26	12	9	4	14.6

ID	ID	ID
● 147187	● 152302	● 148031
● 147189	● 152303	● 152310
● 146395		
● 147169		

* SA420-4= 3

aero

SA390-3



16 53

SA390-3

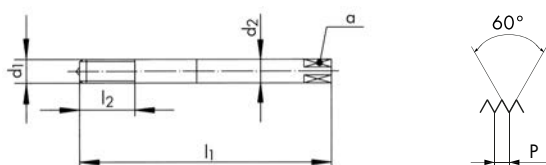

$\emptyset'' d_1$ UNF	P TPI	d_1 mm	l_1 mm	l_2 mm	d_2 mm	a mm			ID
10	32	4.82	70	15	6	4.9	3	4.15	● 149687
1/4	28	6.35	80	20	7	5.5	3	5.55	● 149715
5/16	24	7.93	90	25	8	6.2	3	7	● 149728
3/8	24	9.52	100	30	10	8	3	8.6	● 149745



NEW

LE PARFAIT "ALLROUNDER"

Disponibile pour filetages M, MF, UNC, UNF et G

IL PERFETTO "ALLROUNDER"

Disponibile per filettature M, MF, UNC, UNF e G





PM

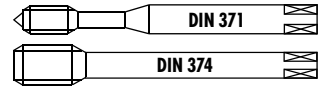

QTAP

Q320VS-4



Q420VS-4



Q323VS-4



Q423VS-4



- 11 12 13 14
- 15 21 22 23
- 24 31 32 51
- 52 61 62 63
- 64 71 72 73
- 74 81 82 83
- 91 92 94

Q320VS-4

Q420VS-4

Q323VS-4

Q423VS-4



NEW



NEW



NEW



NEW

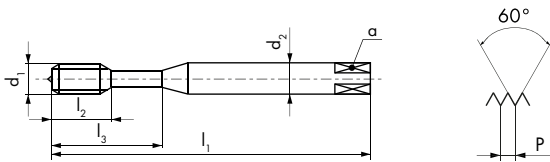

2B



2B



2B



2B

Ø" d ₁ UNF	P TPI	d ₁ mm	l ₁ mm	l ₂ mm	l ₃ mm	d ₂ mm	a mm		
10	32	4.82	70	15	25	6	4.9	3	4.05
1/4	28	6.35	80	17	30	7	5.5	3	5.5
5/16	24	7.93	90	20	35	8	6.2	3	6.9
3/8	24	9.52	100	22	39	10	8	3	8.5
7/16	20	11.11	100	19		8	6.2	3	9.8
1/2	20	12.7	100	24		9	7	3	11.4

ID

ID

ID

ID

● 196298

● 197631

● 196299

● 197632

● 196300

● 197633

● 196301

● 197634

● 196302

● 197635

● 196303

● 197636



≤ Ø 16 > Ø 16

PM HSSE

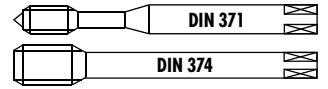

QTAP

Q360VS-3



Q460VS-3

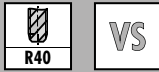

Q363VS-3



Q463VS-3

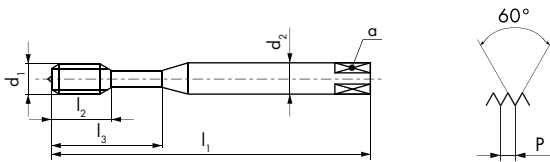

Q360VS-3

Q460VS-3

Q363VS-3

Q463VS-3



NEW



NEW



NEW



NEW



< 2.5 x D



< 2.5 x D



< 2.5 x D



< 2.5 x D



2.5 x P

2B



2.5 x P

2B



2.5 x P

2B



2.5 x P

2B

Ø" d ₁ UNF	P TPI	d ₁ mm	l ₁ mm	l ₂ mm	l ₃ mm	d ₂ mm	a mm		
10	32	4.82	70	9	25	6	4.9	3	4.05
1/4	28	6.35	80	11	30	7	5.5	3	5.5
5/16	24	7.93	90	12.5	35	8	6.2	3	6.9
3/8	24	9.52	100	14	39	10	8	3	8.5
7/16	20	11.11	100	14		8	6.2	3	9.8
1/2	20	12.7	100	14		9	7	3	11.4
5/8	18	15.87	100	14		12	9	3	14.5
3/4	16	19.05	125	18		14	11	4	17.5

ID

ID

ID

ID

● 196304

● 197637

● 196305

● 197638

● 196306

● 197639

● 196307

● 197640

● 196308

● 197641

● 196309

● 197642

● 196310

● 197643

● 196311

● 197644

UNF ASME B1.1



Uniquement pour taraudage synchrone
Nur für Synchrobearbeitung
Only for rigid tapping
Solo per maschiatura sincrona
Solo para rosado sincrozado
Тільки для рiгiд tapping

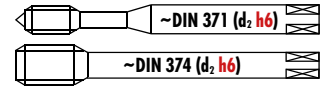

RTS Rigid Tapping Synchro

RTS320VS-4



RTS420VS-4

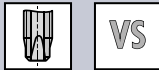

RTS362VS-3

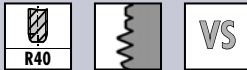

RTS462VS-3





RTS320VS-4

RTS420VS-4

RTS362VS-3

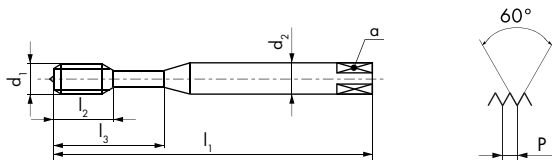
RTS462VS-3



\emptyset " d ₁ UNF	P TPI	d ₁ mm	l ₁ mm	l ₂ mm	l ₃ mm	d ₂ h ₆ mm	a mm		
10	32	4.82	70	9	25	6	4.9	3	4.05
1/4	28	6.35	80	11	30	* 6	* 4.9	3	5.5
5/16	24	7.93	90	12.5	35	8	6.2	3	6.9
3/8	24	9.52	100	14	39	10	8	3	8.5
1/2	20	12.7	110	14		* 10	* 8	3	11.4

ID	ID	ID	ID
● 157409		● 157413	
● 157410		● 157414	
● 157411		● 157415	
● 157412		● 157416	
	● 157417		● 157418

* Norme DC / * DC Norm/ * Norma DC



sur demande
auf Anfrage
on request
su richiesta
sobre pedido
но запычы



W | IMPROVING
THREADING









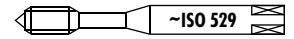

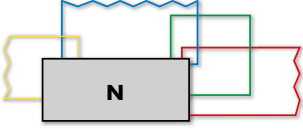





UNF ASME B1.1

≤ Ø 2.8 > Ø 2.8

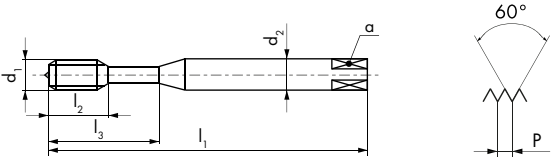
PM HSS



										N1110-1	N1110-3	N1110-S
										N1110-1		
N1110-3												
N1110-S												
												
										2B	2B	
Ø" d ₁ UNF	P TPI	d ₁ mm	l ₁ mm	l ₂ mm	l ₃ mm	d ₂ mm	a mm			ID	ID	ID
0	80	1.52	40	7		2.5	2.1	3	1.2	● 102811	● 103010	● 111079
1	72	1.85	40	8		2.5	2.1	3	1.5	● 102812	● 103011	● 111080
8	36	4.16	53	13	21	4.5	3.55	3	3.5		★ 103022	
10	32	4.82	58	16	25	5	4	3	4.05	● 102814	● 103013	● 111082
12	28	5.48	62	17	26	5.6	4.5	3	4.6		★ 103014	
1/4	28	6.35	66	19	30	6.3	5	3	5.5	● 102813	● 103012	● 111081
5/16	24	7.93	72	22	35	8	6.3	3	6.9	● 102821	● 103020	● 111089
3/8	24	9.52	80	24	39	10	8	3	8.5	● 102818	● 103017	● 111086

UNF ASME B1.1

HSS

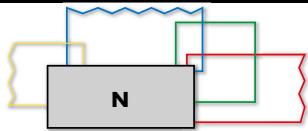
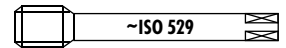

N1210-1



N1210-3

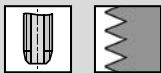

31 62 73 74 91

N1210-S



N1210-1

N1210-3

N1210-S

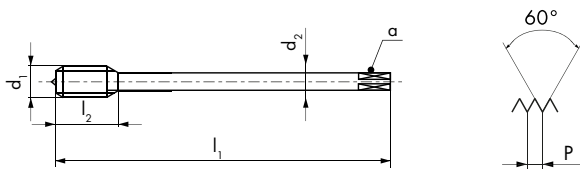

2B

2B

$\emptyset'' d_1$ UNF	P TPI	d_1 mm	l_1 mm	l_2 mm	d_2 mm	a mm		
7/16	20	11.11	85	22	8	6.3	3	9.8
1/2	20	12.7	89	24	9	7.1	3	11.4
5/8	18	15.87	102	32	12.5	10	3	14.5
3/4	16	19.05	112	33	14	11.2	4	17.5
7/8	14	22.22	115	32	16	12.5	4	20.4
1	12	25.4	130	45	18	14	4	23.3

ID

ID

ID

● 103411

● 103626

● 111255

● 103407

● 103622

● 111251

● 103410

● 103625

● 111254

● 103409

● 103624

● 111253

● 103412

● 103627

● 111256

● 103408

● 103623

● 111252

UNEF ASME B1.1

HSS

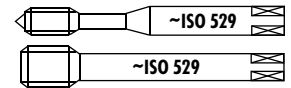

										N1110-3	N1120-4	N1210-3	N1220-4
N1110-3		31	62	73	74	91							
N1120-4		62	63	64	72	73	74	81	91				
N1210-3		31	62	73	74	91							
N1220-4		62	63	64	72	73	74	81	91				
\emptyset " d ₁ UNEF	P TPI	d ₁ mm	l ₁ mm	l ₂ mm	l ₃ mm	d ₂ mm	a mm			ID	ID	ID	ID
12	32	5.48	62	17	26	5.6	4.5	3	4.7	● 103007	● 103118		
1/4	32	6.35	66	19	30	6.3	5	3	5.6	● 103006	● 103117		
5/16	32	7.93	72	22	35	8	6.3	3	7.2	● 103009	● 103120		
3/8	32	9.52	80	24	39	10	8	3	8.75	● 103008	● 103119		
7/16	28	11.11	85	22		8	6.3	3	10.25			● 103615	● 103754
1/2	28	12.7	89	24		9	7.1	3	11.85			● 103609	● 103749
9/16	24	14.28	95	24		11.2	9	3	13.2			● 103617	● 103756
5/8	24	15.87	102	32		12.5	10	3	14.8			● 103614	● 103753
11/16	24	17.46	104	26		14	11.2	4	16.4			● 103611	
3/4	20	19.05	112	33		14	11.2	4	17.8			● 103613	
7/8	20	22.22	115	32		16	12.5	4	21			● 103616	
1	20	25.4	120	30		18	14	4	24.1			● 103610	

UNS, UN ASME B1.1





















HSSE



										N410-3	N460-3	N460V-3
N410-3 31 62 73 74 91												
N460-3 R40 63 72 73 74 81 91												
N460V-3 R40 V 11 12 32												
										2B	2B	2B
$\emptyset'' d_1$ UNS	P TPI	d_1 mm	l_1 mm	l_2 mm	d_2 mm	a mm				ID	ID	ID
1/4	36	6.35	80	17	4.5	3.4	3	5.65	● 104899			
1/2	24	12.7	100	24	9	7	3	11.6	● 104900			
1	14	25.4	140	34	18	14.5	4	23.6	● 104898			
1	14	25.4	140	22	18	14.5	4	23.6		● 102437	● 142789	
$\emptyset'' d_1$ UN	P TPI	d_1 mm	l_1 mm	l_2 mm	d_2 mm	a mm				ID	ID	
1 1/8	8	28.57	180	30	22	18	4	25.5		● 102415	● 142790	
1 1/4	8	31.75	180	30	22	18	4	28.7		● 102414	● 142520	
1 3/8	8	34.92	200	36	28	22	5	31.8		● 104896	● 142792	
1 1/2	8	38.1	200	40	32	24	5	35		● 102413	● 142793	
1 3/4	8	44.45	220	44	36	29	5	41.4			● 115198	
2	8	50.8	250	38	40	32	5	47.7			● 111622	





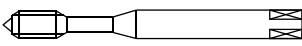
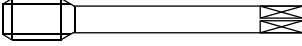



















G Répertoire — Tarauls à machine G (BSP) DIN EN ISO 228









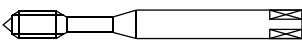
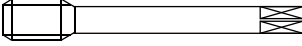









Rubrica — Maschi a macchina G (BSP) DIN EN ISO 228

		N						
Caractéristiques Caratteristiche			 V	 TiN	 R40	 R40 V	 R40 TiN	 R40 V
								
Genre de trou Tipo di foro								
								
		N410-3	N420-4 N420V-4	N420TN-4	N460-3	N460V-3	N460TN-3	N462V-3
DIN longue DIN lungo	DIN 5156	204	205	205	206	206	206	206
DIN longue DIN lungo	~ DIN 376							
DIN courte DIN corto	DIN 5157							
LH Filetage à gauche LH Filettatura sinistra	DIN 5156	204						

G Répertoire — Tarauls à machine G (BSP) DIN EN ISO 228

Rubrica — Maschi a macchina G (BSP) DIN EN ISO 228

	H	GG	QTAP		RTS	
Caractéristiques Caratteristiche	 R25	 R15  NV	 VS	 R40  VS	 R40  VS	 R40  E 1.5xP  VS
			 	 		
			NEW	NEW		
Genre de trou Tipo di foro						
						
	H450-3	GG450NV-3	Q420VS-4 Q423VS-4	Q460VS-3 Q463VS-3	RTS462VS-3	RTS462VS-5
DIN longue DIN lungo DIN 5156	207	207	210	211		
DIN longue DIN lungo ~ DIN 376					212	212
DIN courte DIN corto DIN 5157						
LH Filetage à gauche LH Filettatura sinistra DIN 5156						

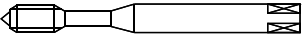
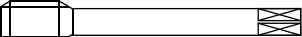
	N					
Caractéristiques Caratteristiche		 		 		 
						
Genre de trou Tipo di foro						
				N1110-3	N1120-4	
ISO courte ISO corto	ISO 529			216 - 217	216	
W	ISO 529			216 - 217	216	
SV	ISO 529			217		
	N420-3	N410-3	D5800	N1210-3	N1220-4	N5120
DIN longue DIN lungo	DIN 5156	214				
DIN longue DIN lungo	DC		214	215		
ISO courte ISO corto	ISO 529			216 - 217	216	
Rp	DIN 5156	214				
Rc	DC		214	215		
W	ISO 529			216	216	
SV	ISO 529 / DC			217		217

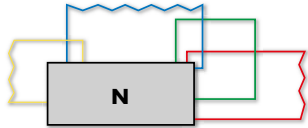

N410-3



31 / **62** / 73 / 74 / 91

N410-3 LH



LH







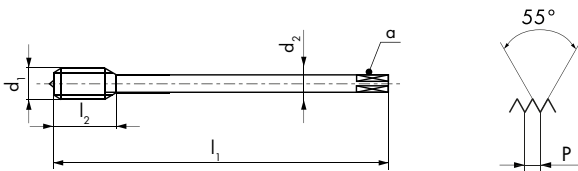



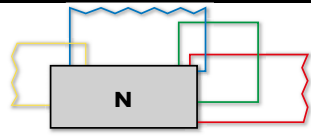

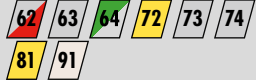





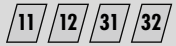





31 / **62** / 73 / 74 / 91

N410-3

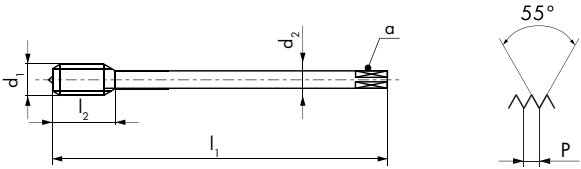
N410-3 LH



$\frac{\text{Ø}''}{G}$	d_1	P	d_1	l_1	l_2	d_2	a			ID	ID
		TPI	mm	mm	mm	mm	mm				
1/8	28	9.72	90	22	7	5.5	3	8.75	●	101855	
1/4	19	13.15	100	20	11	9	3	11.6	●	101853	● 101854
3/8	19	16.66	100	20	12	9	4	15.2	●	101861	● 101862
1/2	14	20.95	125	22	16	12	4	18.9	●	101851	● 101852
3/4	14	26.44	140	28	20	16	4	24.4	●	101859	
1	11	33.24	160	32	25	20	4	30.7	●	101857	
1 1/4	11	41.91	170	32	32	24	5	39.3	●	101850	
1 1/2	11	47.8	190	32	36	29	5	45.2	●	101849	

										N420-4	N420V-4	N420TN-4
N420-4												
N420V-4	 											
N420TN-4	 											
												
$\frac{\text{Ø}''}{G}$ d_1	P TPI	d_1 mm	l_1 mm	l_2 mm	d_2 mm	a mm			ID	ID	ID	
1/16	28	7.72	90	18	6	4.9	3	6.75	● 102045			
1/8	28	9.72	90	22	7	5.5	3	8.75	● 102048	● 102258	● 102236	
1/4	19	13.15	100	20	11	9	3	11.6	● 102047	● 102257	● 102235	
3/8	19	16.66	100	20	12	9	3	15.2	● 102053	● 102261	● 102238	
1/2	14	20.95	125	22	16	12	4	18.9	● 102046	● 102256	● 102234	
5/8	14	22.91	125	25	18	14.5	4	20.9	● 102054	● 144722		
3/4	14	26.44	140	28	20	16	4	24.4	● 102052	● 102260	● 102237	
1	11	33.24	160	32	25	20	4	30.7	● 102049	● 102259		
1 1/4	11	41.91	170	32	32	24	5	39.3	● 102043			
1 1/2	11	47.8	190	32	36	29	5	45.2	● 102042			
2	11	59.61	220	36	45	35	5	57	● 102051			
2 1/2	11	75.18	280	36	50	39	6	72.6	● 102050			

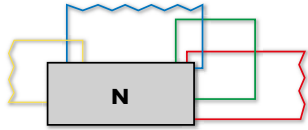

N460-3			63 72 73 74 81 91	
N460V-3			11 12 32	
N460TN-3			11 12 13 14 32	
N462V-3				11 12 32

N460-3	N460V-3	N460TN-3	N462V-3
--------	---------	----------	---------



--	--	--	--

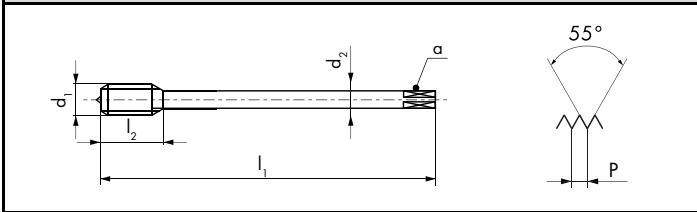

--	--	--	--

$\frac{\text{Ø}''}{G}$	P TPI	d_1 mm	l_1 mm	l_2 mm	d_2 mm	a mm			ID	ID	ID	ID
1/16	28	7.72	90	12.5	6	4.9	3	6.75	● 102341			
1/8	28	9.72	90	14	7	5.5	3	8.75	● 102344	● 102457	● 102444	● 143687
1/4	19	13.15	100	14	11	9	3	11.6	● 102343	● 102456	● 102443	● 143600
3/8	19	16.66	100	14	12	9	4	15.2	● 102348	● 102460	● 102446	● 143431
1/2	14	20.95	125	20	16	12	4	18.9	● 102342	● 102455	● 102442	● 143921
5/8	14	22.91	125	20	18	14.5	4	20.9	● 102349	● 143711		
3/4	14	26.44	140	22	20	16	4	24.4	● 102347	● 102459	● 102445	● 143688
1	11	33.24	160	26	25	20	4	30.7	● 102345	● 102458		
1 1/4	11	41.91	170	30	32	24	5	39.3	● 102340	● 111608		
1 1/2	11	47.8	190	35	36	29	5	45.2	● 102339	● 111609		
2	11	59.61	220	41	45	35	6	57	● 102346	● 111503		

G DIN EN ISO 228 (BSP)

≤ Ø 25.4 > Ø 25.4



										W460-5	W460DL-5	H450-3	GG450NV-3
W460-5 71 72 81													
W460DL-5 71 72 73													
H450-3 15 16 62 64 82													
GG450NV-3 31													
Ø" d ₁ G	P TPI	d ₁ mm	l ₁ mm	l ₂ mm	d ₂ mm	a mm				ID	ID	ID	ID
1/8	28	9.72	90	14	7	5.5	3		8.75	● 119350	● 176728	● 101298	
1/4	19	13.15	100	14	11	9	* 4		11.6	● 119300	● 176729	● 101297	
3/8	19	16.66	100	14	12	9	4		15.2	● 119682	● 176730	● 101301	
1/2	14	20.95	125	20	16	12	4		18.9	● 119199	● 176731	● 101296	
3/4	14	26.44	140	22	20	16	4		24.4			● 101300	
1	11	33.24	160	26	25	20	4		30.7			● 101299	
* W460-5 = 3 * W460DL-5 = 3													
Ø" d ₁ G	P TPI	d ₁ mm	l ₁ mm	l ₂ mm	d ₂ mm	a mm				ID			
1/8	28	9.72	90	22	7	5.5	4		8.75	● 102309			
1/4	19	13.15	100	20	11	9	4		11.6	● 102308			
3/8	19	16.66	100	20	12	9	4		15.2	● 102312			
1/2	14	20.95	125	22	16	12	4		18.9	● 102307			
3/4	14	26.44	140	28	20	16	4		24.4	● 102311			
1	11	33.24	160	32	25	20	4		30.7	● 102310			

G DIN EN ISO 228 (BSP)

< Ø 25.4 > Ø 25.4

PM	HSSE	HSSE
Z420	Z420	Z460



										Z420V-4	Z420VS-4	Z460V-3	
Z420V-4			<div style="display: flex; flex-wrap: wrap; gap: 5px;"> 11121321 32 </div>										
Z420VS-4			<div style="display: flex; flex-wrap: wrap; gap: 5px;"> 11121314 21222332 616394 </div>										
Z460V-3			<div style="display: flex; flex-wrap: wrap; gap: 5px;"> 122132 </div>										
Ø" d ₁ G	P TPI	d ₁ mm	l ₁ mm	l ₂ mm	d ₂ mm	a mm				ID	ID		
1/8	28	9.72	90	22	7	5.5	3	8.75	●	142794	●	142800	
1/4	19	13.15	100	20	11	9	3	11.6	●	142795	●	119303	
3/8	19	16.66	100	20	12	9	3	15.2	●	142796	●	142802	
1/2	14	20.95	125	22	16	12	4	18.9	●	142797	●	142803	
3/4	14	26.44	140	28	20	16	4	24.4	●	142798			
1	11	33.24	160	32	25	20	4	30.7	●	142799			
Ø" d ₁ G	P TPI	d ₁ mm	l ₁ mm	l ₂ mm	d ₂ mm	a mm				ID			
1/8	28	9.72	90	14	7	5.5	3	8.75		● 104726			
1/4	19	13.15	100	14	11	9	3	11.6		● 104725			
3/8	19	16.66	100	14	12	9	4	15.2		● 104728			
1/2	14	20.95	125	20	16	12	4	18.9		● 104724			
3/4	14	26.44	140	22	20	16	4	24.4		● 104727			
1	11	33.24	160	26	25	20	4	30.7		● 105142			

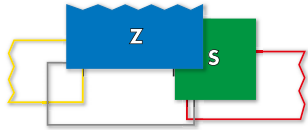

Z470VS-3

Z470VS-3



VS



Z470VS-3



VS

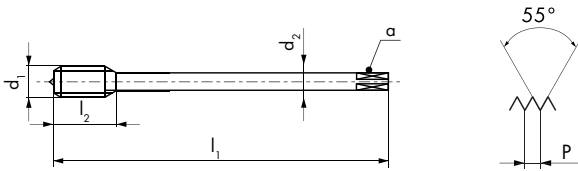

$\emptyset'' d_1$ G	P TPI	d_1 mm	l_1 mm	l_2 mm	$d_2 h_6$ mm	a mm			ID
1/8	28	9.72	100	14	* 8	* 6.2	3	8.75	● 165198
1/4	19	13.15	110	14	* 12	* 9	4	11.6	● 165199
3/8	19	16.66	110	18	12	9	4	15.2	● 165200
1/2	14	20.95	125	20	16	12	4	18.9	● 165201

* Norme DC / * DC Norm/ * Norma DC



QTAP

Q420VS-4



VS

Q423VS-4



VS

- 11 12 13 14
- 15 21 22 23
- 24 31 32 51
- 52 61 62 63
- 64 71 72 73
- 74 81 82 83
- 91 92 94

Q420VS-4

Q423VS-4



NEW



NEW

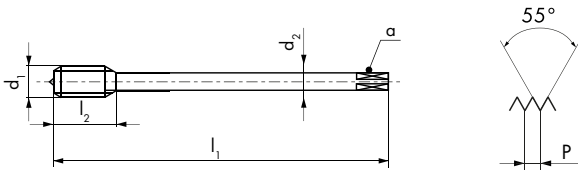

Ø" d ₁ G	P TPI	d ₁ mm	l ₁ mm	l ₂ mm	d ₂ mm	a mm		
1/8	28	9.72	90	22	7	5.5	3	8.75
1/4	19	13.15	100	20	11	9	3	11.6
3/8	19	16.66	100	20	12	9	3	15.2
1/2	14	20.95	125	22	16	12	4	18.9

ID

ID

● 196312

● 197645

● 196313

● 197646

● 196314

● 197647

● 196315

● 197648

G

DIN EN ISO 228 (BSP)



≤ Ø 16 > Ø 16

PM

HSSE



QTAP

Q460VS-3



Q463VS-3



- 11 12 13 14
- 15 21 22 23
- 24 31 32 51
- 52 61 62 63
- 64 71 72 73
- 74 81 82 83
- 91 92 94

Q460VS-3

Q463VS-3



NEW



NEW

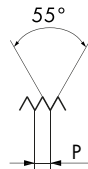
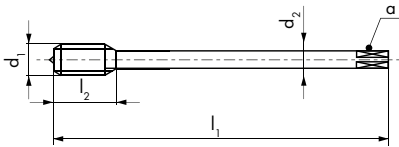

Ø" d ₁ G	P TPI	d ₁ mm	l ₁ mm	l ₂ mm	d ₂ mm	a mm		
1/8	28	9.72	90	14	7	5.5	3	8.75
1/4	19	13.15	100	14	11	9	3	11.6
3/8	19	16.66	100	14	12	9	4	15.2
1/2	14	20.95	125	20	16	12	4	18.9

ID

ID

- 196316 ● 197649
- 196317 ● 197650
- 196318 ● 197651
- 196319 ● 197652

G

DIN EN ISO 228 (BSP)



Uniquement pour taraudage synchrone
 Nur für Synchrobearbeitung
 Only for rigid tapping
 Solo per maschiatura sincrona
 Solo para roscado sincronizado
 Тільки для рiгiд tapping

PM



RTS

Rigid Tapping Synchro

RTS462VS-3



RTS462VS-5

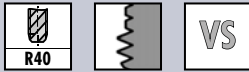

RTS462VS-3

RTS462VS-5

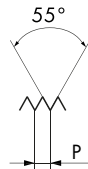
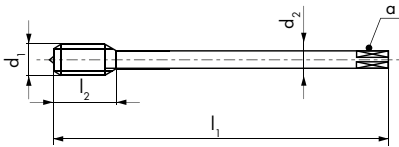

$\frac{\text{Ø}''}{G}$ d ₁	P TPI	d ₁ mm	l ₁ mm	l ₂ mm	d ₂ h6 mm	a mm		
1/8	28	9.72	100	14	* 8	* 6.2	3	8.75
1/4	19	13.15	110	14	* 12	* 9	3	11.6
3/8	19	16.66	110	18	12	9	4	15.2
1/2	14	20.95	125	20	16	12	4	18.9

ID	ID
● 151861	● 170629
● 151868	● 170631
● 151872	● 170633
● 150685	● 170635

* Norme DC / * DC Norm/ * Norma DC



sur demande
 auf Anfrage
 on request
 su richiesta
 sobre pedido
 no zapytany

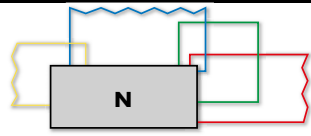

N210-1			
N210-3			31 62 73 74 91
N210-S			

N210-1	N210-3	N210-S	
--------	--------	--------	--

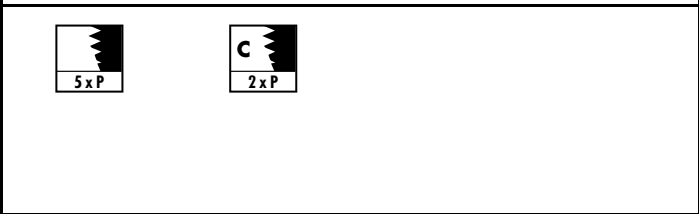
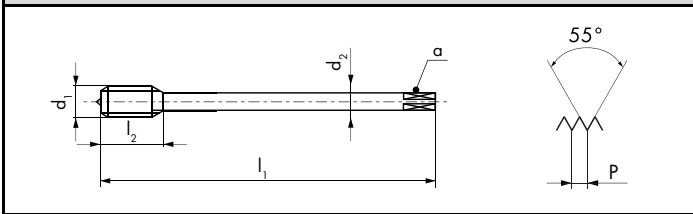
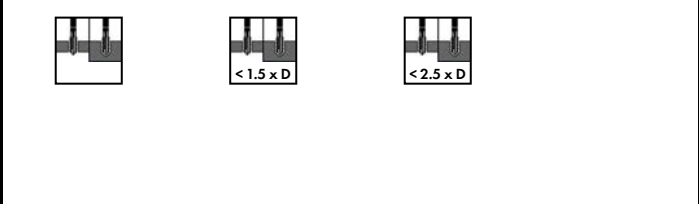

$\frac{\text{Ø}''}{\text{G}}$	d_1 TPI	d_1 mm	l_1 mm	l_2 mm	d_2 mm	a mm			ID	ID	ID
1/16	28	7.72	63	18	6	4.9	3	6.75		● 101418	
1/8	28	9.72	63	22	7	5.5	3	8.75	● 101404	● 101421	● 119386
1/4	19	13.15	70	20	11	9	3	11.6	● 101403	● 101420	● 119336
3/8	19	16.66	70	20	12	9	4	15.2	● 101409	● 101427	● 110938
1/2	14	20.95	80	22	16	12	4	18.9	● 101402	● 101419	● 119264
5/8	14	22.91	80	25	18	14.5	4	20.9	● 101411	● 105140	● 110940
3/4	14	26.44	90	28	20	16	4	24.4	● 101408	● 101426	● 110937
1	11	33.24	100	32	25	20	4	30.7	● 101405	● 101422	● 110933
1 1/8	11	37.89	125	32	28	22	4	35.3		● 101415	
1 1/4	11	41.91	125	32	32	24	5	39.3	● 101400	● 101414	● 111425
1 1/2	11	47.8	140	32	36	29	5	45.2	● 101399	● 101413	● 110934
2	11	59.61	160	36	45	35	5	57	● 101407	● 101425	● 110935
2 1/2	11	75.18	160	36	50	39	6	72.6		● 101423	

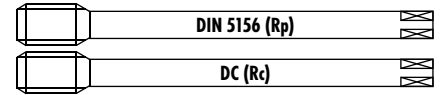

Rp, Rc DIN EN 10226

HSSE

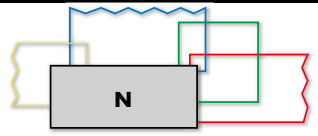

		N420-3			N410-3				
N420-3									
N410-3									
$\emptyset'' d_1$ Rp	P TPI	d_1 mm	l_1 mm	l_2 mm	d_2 mm	a mm			ID
1/8	28	9.72	90	22	7	5.5	3	8.6	● 104911
1/4	19	13.15	100	20	11	9	3	11.5	● 104912
3/8	19	16.66	100	20	12	9	3	15	● 104913
1/2	14	20.95	125	22	16	12	4	18.5	● 104914
3/4	14	26.44	140	28	20	16	4	24	● 104915
1	11	33.24	160	32	25	20	4	30.25	● 104916
$\emptyset'' d_1$ Rc	P TPI	d_1 mm	l_1 mm	l_2 mm	d_2 mm	a mm			ID
1/8	28	9.72	71	13	8	6.2	5		● 104917
1/4	19	13.15	80	20	11	9	5		● 104918
3/8	19	16.66	90	20	12	9	5		● 104919
1/2	14	20.95	100	26	16	12	5		● 104920
3/4	14	26.44	110	26	20	16	5		● 104921
1	11	33.24	125	32	25	20	5		● 104922

Vc (m/min) $\emptyset d_1$ - Guide Line				
Rc	1/16" - 1/4"	3/8" - 1/2"	3/4" - 1"	1.1/4" - 2"
	10	8	7	5
	18	15	13	10

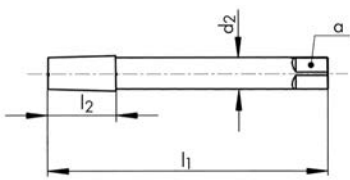
					D5800			
D5800 								
								
Ø" Rc	l₁ mm	l₂ mm	d₂ mm	a mm	ID			
1/16	70	17	6	4.9	● 118701			
1/8	70	17	8	6.2	● 110531			
1/4	80	27	10	8	● 110530			
3/8	85	27	12	9	● 110535			
1/2	95	35	16	12	● 110529			
3/4	105	35	20	16	● 110534			
1	130	43	25	20	● 110532			

Avant-trous pour filetages gaz coniques selon DIN EN 10226

Prefori per filettature gas conici secondo DIN EN 10226

Avant-trous cylindriques
Usure plus rapide du taraud, à éviter

Preforo cilindrico
Comporta un'usura più rapida del maschio, da evitare

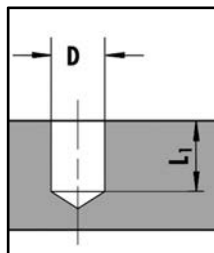

Avant-trous coniques 1:16
Perçer cylindrique selon Ø D₂ et aléser conique selon Ø D₃

Preforo conico 1:16
Forare con punta cilindrica secondo il Ø D₂ e quindi alesare conico secondo Ø D₃

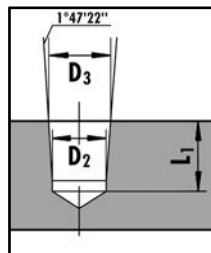

Taraudage
Tarauder jusqu'à la profondeur L₂ = Ø nominale

Filettatura
Filettare fino alla profondità L₂ = Ø nominale

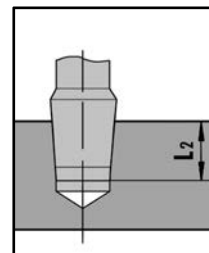

Ø" Rc	L₁ min. mm	D₁ mm	D₂ mm	D₃ mm	L₂ mm
1/16	11.9	6.2	6.1	6.56	10.6
1/8	11.9	8.2	8.1	8.57	10.6
1/4	17.7	11	10.75	11.45	15.7
3/8	18.1	14.5	14.25	14.95	16.1
1/2	24	18	17.75	18.63	21.4
3/4	25.3	23.5	23	24.12	21.5
1	30.6	29.5	29	30.29	26.3

W BS 84 (BSW)

HSS

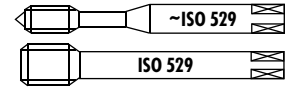



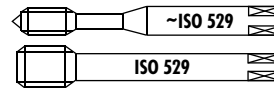









										N1110-3	N1210-3	N1120-4	N1220-4
N1110-3													
N1210-3													
N1120-4													
N1220-4													
\emptyset " d ₁ W	P TPI	d ₁ mm	l ₁ mm	l ₂ mm	l ₃ mm	d ₂ mm	a mm			ID	ID	ID	ID
1/8	40	3.17	48	11	18	3.15	2.5	3	2.5	● 103025		● 103126	
5/32	32	3.96	53	13	21	4	3.15	3	3.1	● 103031		● 103130	
3/16	24	4.76	58	16	25	5	4	3	3.6	● 103026		● 103127	
1/4	20	6.35	66	19	30	6.3	5	3	4.9	● 103024		● 103125	
5/16	18	7.93	72	22	35	8	6.3	3	6.4	● 103030		● 103129	
3/8	16	9.52	80	24	39	10	8	3	7.7	● 103028		● 103128	
7/16	14	11.11	85	22		8	6.3	3	9.1		● 103642		● 103771
1/2	12	12.7	89	24		9	7.1	3	10.3		● 103634		● 103767
5/8	11	15.87	102	32		12.5	10	3	13.3		● 103641		● 103770
3/4	10	19.05	112	33		14	11.2	3	16.2		● 103640		● 103769



										N1110-3	N1210-3	N5120						
N1110-3																		
N1210-3																		
N5120																		
$\varnothing d_1$	P	l_1	l_2	l_3	d_2	a				ID								
W	TPI/mm	mm	mm	mm	mm	mm												
5	36/TPI/1"	B6	58	16	25	5	4	3	4.3*	● 103029								
6.82	0.625	B8	66	19	30	7.1	5.6	3	6.2*	● 111143								
$\varnothing d_1$	P	l_1	l_2	l_3	d_2	a				ID	ID							
SV	mm	mm	mm	mm	mm	mm												
10	0.833	W10	80	24	39	10	8	3	* 8.9	● 130429								
12	1.25	W12	89	24		9	7.1	3	* 10.5		● 103591							
15	1.25	W15	90	23		11.2	9	3	* 13.5		● 103592							
20	1.666	W20	112	37		14	11.2	4	* 17.9		● 103593							
25	1.693	W25	120	30		18	14	4	* 22.75		● 103594							
* Tol. $\begin{matrix} \varnothing .1 \text{ mm} \\ 0 \end{matrix}$																		
$\varnothing d_1$	P	d_2	l_1							ID								
W	mm	mm	mm															
6.82	0.625	B6	25	9	4	6.75				● 130215								





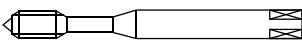
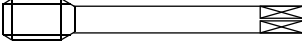

















NPT, NPTF

Tarauls à machine, NPT ASME B1.20.1 et NPTF ANSI B1.20.3
Maschi a macchina, NPT ASME B1.20.1 e NPTF ANSI B1.20.3

		N			
Caractéristiques Caratteristiche			 	 	 1:16
					
Genre de trou Tipo di foro					
					
		N410-3	N410V-3	N411V-3	D5800
NPT DIN longue NPT DIN lungo	DC	220	220	220	221
NPTF DIN longue NPTF DIN lungo	DC	220			

PG, TR

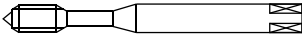
Taravds à machine et à main, PG DIN 40430, TR ISO 2901-2904, DIN 103
 Maschi a macchina e a mano, PG DIN 40430, TR ISO 2901-2904, DIN 103

	N					
Caractéristiques Caratteristiche		 	 	 	 	 
						
Genre de trou Tipo di foro						
						
	N420-3	N410-1	N410-2	N410-3	N410-5	N410-8
PG DIN longue PG DIN lungo	DIN 40433					
	222					
TR DIN longue TR DIN lungo	DC	223	223	223	223	222
Tolérance Tolleranza	TR 7H			223	223	222

NPT, NPTF

ASME B1.20.1, ANSI B1.20.3

HSSE

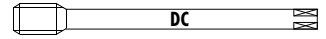

					D5800			
D5800								
Ø" NPT, NPTF	l ₁ mm	l ₂ mm	d ₂ mm	a mm	ID			
1/16	70	17	6	4.9	● 118701			
1/8	70	17	8	6.2	● 110531			
1/4	80	27	10	8	● 110530			
3/8	85	27	12	9	● 110535			
1/2	95	35	16	12	● 110529			
3/4	105	35	20	16	● 110534			
1	130	43	25	20	● 110532			

Avant-trous pour filetages NPT et NPTF Prefori per filettature NPT e NPTF

Avant-trous cylindriques
Usure plus rapide du taraud, à éviter

Preforo cilindrico
Comporta un'usura più rapida del maschio, da evitare

Avant-trous coniques 1:16
Perçer cylindrique selon Ø D₂ et aléser conique selon Ø D₃

Preforo conico 1:16
Forare con punta cilindrica secondo il Ø D₂ e quindi alesare conico secondo Ø D₃

Taroudage
Tarauder jusqu'à la profondeur L₃ = Ø nominale

Filettatura
Filettare fino alla profondità L₃ = Ø nominale

*Il est recommandé d'aléser D₃ au maximum

*Si raccomanda d'alesare D₃ al valore massimo

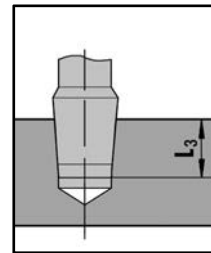
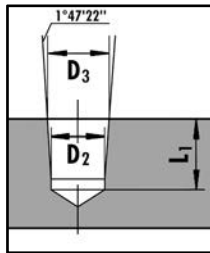
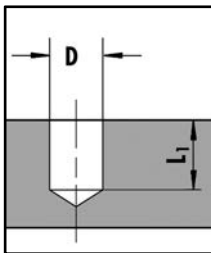



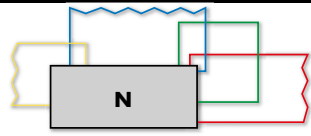
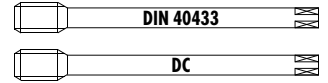

Ø" NPT, NPTF	D mm	L ₁ mm	D ₂ mm	NPT	NPTF	L ₃ mm
				D ₃ (+0.05) mm	D ₃ (+0.05) mm	
1/16	6.15	12	6	6.39	6.41	10.2
1/8	8.5	12	8.3	8.74	8.76	10.3
1/4	11	17.5	10.8	11.36	11.4	15.1
3/8	14.5	17.5	14.2	14.8	14.84	15.3
1/2	17.9	23	17.5	18.32	18.33	20
3/4	23.2	23	22.8	23.67	23.68	20.5
1	29	28	28.6	29.69	29.72	24.6

PG DIN 40430 TR ISO 2901-2904, DIN 103

HSSE

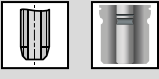



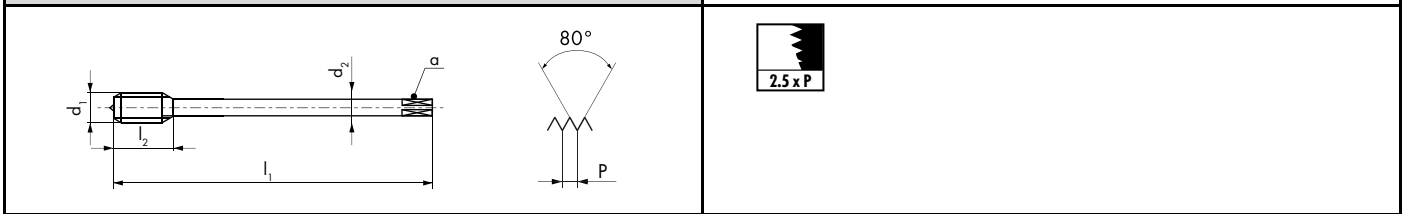



















<p>N420-3</p>  <p>61 63 71 72 73 81</p>	<p>N420-3</p> 		<p>N410-8</p> 
<p>N410-8</p>  <p>31 62 74</p>			 <p>< 1.5 x D</p>

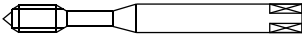

Ø d ₁ PG	P TPI	d ₁ mm	l ₁ mm	l ₂ mm	d ₂ mm	a mm			ID
7	20	12.5	100	24	9	7	3	11.3	● 104901
9	18	15.2	100	26	12	9	3	13.9	● 104902
11	18	18.6	110	26	14	11	4	17.3	● 104903
13.5	18	20.4	125	28	16	12	4	19.1	● 104904
16	18	22.5	125	28	18	14.5	4	21.2	● 104905
21	16	28.3	150	36	22	18	4	26.8	● 104906
29	16	37	170	38	28	22	4	35.5	● 104907
36	16	47	190	38	36	29	5	45.5	● 104908

























































































































Ø d ₁ TR	P mm	l ₁₁ mm	l ₂ mm	d ₁₀ mm	d ₂ mm	a mm			ID
10	2	100	45	8.2	7	5.5	3	8.2	● 102008
12	3	140	75	9.25	8	6.2	3	9.25	● 102009
14	3	150	75	11.25	10	8	3	11.25	● 102010
16	4	180	100	12.25	11	9	3	12.25	● 102011
18	4	180	100	14.25	12	9	3	14.25	● 102012
20	4	190	100	16.25	14	11	3	16.25	● 102013
22	5	220	110	17.25	16	12	4	17.25	● 111616
24	5	220	110	19.25	18	14.5	4	19.25	● 102015

										N410-1	N410-2	N410-3	N410-S
N410-1 													
N410-2 													
N410-3 													
N410-S 													
										<div style="border: 1px solid black; padding: 2px; display: inline-block;">7H</div>		<div style="border: 1px solid black; padding: 2px; display: inline-block;">7H</div>	
$\emptyset d_1$ TR	P mm	l_{11} mm	l_2 mm	d_{10} mm	d_2 mm	a mm			ID	ID	ID	ID	
10	2	85	30	8.2	7	5.5	3	8.2	* 101827	* 101838	* 101979	* 110972	
16	4	165	65	12.25	11	9	3	12.25	* 101830	* 101841	* 101982	* 110975	
<p><i>En raison de la faible demande, nous ne maintenons plus de jeux de tarauds TR dans notre gamme standard. Sur demande, nous vous les proposons sous forme de produits sur mesure, avec prix et délai de livraison.</i></p> <p><i>A causa della scarsa richiesta, non teniamo più i set di maschi TR nella nostra gamma standard. Su richiesta, saremo lieti di offrirvi questi come prodotti su misura con prezzo e tempi di consegna.</i></p>													

	N				Z	S	
Caractéristiques Caratteristiche 		 V	 R40	 R40 V	 R45 VS	 VS	 R35 VS
							
Genre de trou Tipo di foro 							
	N320-4	N320V-4	N360-3	N360V-3	Z370VS-3	S320VS-4	S360VS-3
DIN longue DIN lungo ~DIN 40435	226	226	227	227			
DIN longue DIN lungo ~DIN 2184-1	230 / 233		230 / 233		231 / 234	234	234
Filetage Filettatura EG M	226	226	227	227			
Filetage Filettatura EG UNC	230		230		231		
Filetage Filettatura EG UNF	233		233		234	234	234
	N420-4	N420V-4	N460-3	N460V-3			
DIN longue DIN lungo ~DIN 40435	226	226	227	227			
DIN longue DIN lungo ~DIN 2184-1	230 / 233		230 / 233				
Filetage Filettatura EG M	226	226	227	227			
Filetage Filettatura EG UNC	230		230				
Filetage Filettatura EG UNF	233		233				

EG

Répertoire — Tardauds à machine pour filets rapportés EG M, EG UNC, EG UNF
 Rubrica — Maschi a macchina per filetti riportati EG M, EG UNC, EG UNF

SA			TL	
				
				
				
				
				
				
				
				
				
				
				
				
				
				
				
				
				
				
				
				
				
				
				
				

EG M ISO DIN 8140



≤ Ø 2.8 > Ø 2.8

PM

HSSE

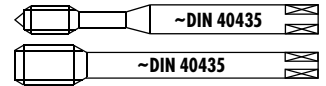

										N320-4	N320V-4	N420-4	N420V-4	
N320-4														
N320V-4		V												
N420-4														
N420V-4		V												
Ø d₁ EG M	P mm	d₁ mm	l₁ mm	l₂ mm	l₃ mm	d₂ mm	a mm			ID	ID	ID	ID	
2	0.4	2.52	50	10		2.8	2.1	3	2.1	● 101537	● 118788			
2.5	0.45	3.08	56	12	18	3.5	2.7	3	2.65	● 101538				
3	0.5	3.65	56	13	20	4	3	3	3.15	● 101539	● 142804			
4	0.7	4.91	70	15	25	6	4.9	3	4.2	● 101540	● 142805			
5	0.8	6.04	80	17	30	6	4.9	3	5.25	● 101541	● 142806			
6	1	7.3	80	17	30	7	5.5	3	6.3	● 101542	● 142807			
8	1.25	9.62	100	22	39	10	8	3	8.4	● 101543	● 142808			
10	1.5	11.94	100	24		9	7	3	10.4			● 102252	● 142809	
12	1.75	14.27	110	28		11	9	3	12.5			● 102253	● 142810	
16	2	18.59	125	33		14	11	3	16.6			● 102255	● 142812	

EG M ISO DIN 8140



≤ Ø 2.8 > Ø 2.8

PM HSSE

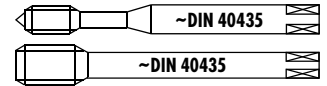

										N360-3	N360V-3	N460-3	N460V-3
N360-3		63 72 73 74 81 91											
N360V-3			11 12 32										
N460-3		63 72 73 74 81 91											
N460V-3			11 12 32										
Ø d ₁ EG M	P mm	d ₁ mm	l ₁ mm	l ₂ mm	l ₃ mm	d ₂ mm	a mm			ID	ID	ID	ID
2	0.4	2.52	50	9		2.8	2.1	2	2.1	● 101599			
2.5	0.45	3.08	56	5.5	18	3.5	2.7	3	2.65	● 101600			
3	0.5	3.65	56	6.5	20	4	3	3	3.15	● 101601	● 142813		
4	0.7	4.91	70	9	25	6	4.9	3	4.2	● 101602	● 142814		
5	0.8	6.04	80	11	30	6	4.9	3	5.25	● 101603	● 142815		
6	1	7.3	80	11	30	7	5.5	3	6.3	● 101604	● 142816		
8	1.25	9.62	100	14	39	10	8	3	8.4	● 101605	● 142817		
10	1.5	11.94	100	14		9	7	3	10.4			● 102335	● 142818
12	1.75	14.27	110	14		11	9	3	12.5			● 102336	● 142819
14	2	16.59	110	18		12	9	3	14.6			● 102337	● 142820
16	2	18.59	125	21		14	11	3	16.6			● 102338	● 142821



PM

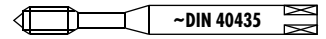

aero

SA320-4



15 16 52 64

SA350-3



15 16 52 64

TL351VS-3



41 42

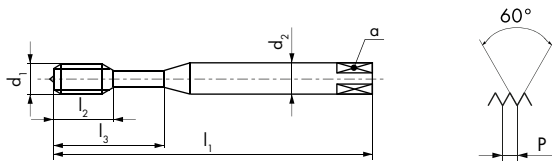

SA320-4

SA350-3

TL351VS-3



< 1.5 x D

< 2 x D



< 2 x D



4 x P



2.5 x P



2.5 x P





6H mod



6H mod



6H mod

Ø d ₁ EG M	P mm	d ₁ mm	l ₁ mm	l ₂ mm	l ₃ mm	d ₂ mm	a mm		
3	0.5	3.65	56	13		4	3	3	3.15
4	0.7	4.91	70	15		6	4.9	3	4.2
5	0.8	6.04	80	15	23	6	4.9	3	5.25
6	1	7.3	80	15	23	7	5.5	3	6.3
8	1.25	9.62	100	20	33	10	8	3	8.4

ID	ID	ID
● 147676	● 147682	● 150478
● 147678	● 147684	● 152003
● 147680	● 147686	● 150184
● 147688	● 147692	● 152005
● 149354	● 149356	● 152089



PM

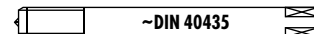

aero

SA390-3



16 53

SA390-3

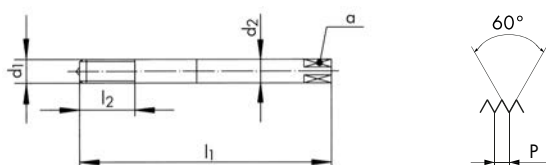

$\emptyset d_1$ EG M	P mm	d_1 mm	l_1 mm	l_2 mm	d_2 mm	a mm		
3	0.5	3.65	56	13	4	3	3	3.15
4	0.7	4.91	70	15	6	4.9	3	4.2
5	0.8	6.04	80	20	6	4.9	3	5.25
6	1	7.3	80	20	7	5.5	3	6.3
8	1.25	9.62	100	30	10	8	3	8.4
10	1.5	11.94	110	35	12	9	3	10.4

ID

- 149669
- 149688
- 149710
- 149723
- 149748
- 149767

EG UNC ASME B18.29.1



HSSE

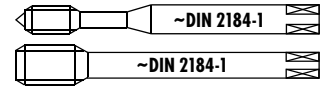

										N320-4	N420-4	N360-3	N460-3	
N320-4		62 63 64 72 73 74 81 91												
N420-4		62 63 64 72 73 74 81 91												
N360-3		63 72 73 74 81 91												
N460-3		63 72 73 74 81 91												
$\emptyset'' d_1$ EG UNC	P TPI	d_1 mm	l_1 mm	l_2 mm	l_3 mm	d_2 mm	a mm			ID	ID	ID	ID	
4	40	3.67	56	13	20	4	3			● 110946				
6	32	4.53	70	15	25	6	4.9			● 110948				
8	32	5.19	70	15	25	6	4.9			● 110949				
1/4	20	8	90	20	35	8	6.2			● 110944				
5/16	18	9.77	100	22	39	10	8			● 110947				
3/8	16	11.58	110	24		9	7				● 110033			
1/2	13	15.23	110	30		12	9				● 104935			
$\emptyset'' d_1$ EG UNC	P TPI	d_1 mm	l_1 mm	l_2 mm	l_3 mm	d_2 mm	a mm			ID	ID	ID	ID	
4	40	3.67	56	6.5	20	4	3				● 110018			
6	32	4.53	70	9	25	6	4.9				● 110019			
8	32	5.19	70	9	25	6	4.9				● 110956			
10	24	6.2	80	11	30	7	5.5				● 110954			
1/4	20	8	90	12.5	35	8	6.2				● 110024			
5/16	18	9.77	100	14	39	10	8				● 111759			
3/8	16	11.58	110	14		9	7					● 111715		
1/2	13	15.23	110	18		12	9					● 111558		

EG UNC ASME B18.29.1



PM

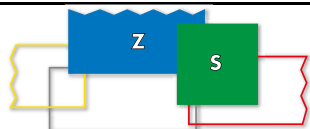
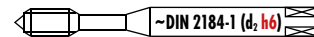

Z370VS-3

Z370VS-3



VS



Z370VS-3



VS

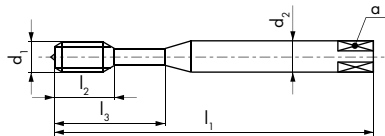

3B

$\emptyset d$ EG UNC	P TPI	d_1 mm	l_1 mm	l_2 mm	l_3 mm	d_2 h6 mm	a mm		
4	40	3.67	56	6.5	20	4(h9)	3	3	3.05
6	32	4.53	70	9	25	6	4.9	3	3.75
8	32	5.19	70	9	25	6	4.9	3	4.45

ID

- 165126
- 165127
- 165128

EG UNC ASME B18.29.1



PM

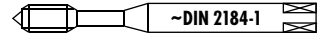

aero

										SA320-4	SA350-3	TL320VS-4	TL351VS-3						
<div style="display: flex; justify-content: space-between;"> <div style="width: 45%;"> <p>SA320-4 15 16 52 64</p> <p>SA350-3 15 16 52 64</p> </div> <div style="width: 50%; text-align: center;"> </div> </div>																			
<div style="display: flex; justify-content: space-between;"> <div style="width: 45%;"> <p>TL320VS-4 41 42</p> <p>TL351VS-3 41 42</p> </div> <div style="width: 50%; text-align: center;"> </div> </div>																			
										<div style="display: flex; justify-content: space-around;"> <div style="text-align: center;"> 3B</div> <div style="text-align: center;"> 3B</div> <div style="text-align: center;"> 3B</div> <div style="text-align: center;"> 3B</div> </div>									
\emptyset " d_1 EG UNC	P TPI	d_1 mm	l_1 mm	l_2 mm	l_3 mm	d_2 mm	a mm			ID	ID	ID	ID						
4	40	3.67	56	13		4	3	3	3.05	● 149073	● 149075		● 152031						
6	32	4.53	70	15		6	4.9	3	3.75	● 149121	● 149123	* 152040	● 152041						
8	32	5.19	70	15		6	4.9	3	4.45	● 149170	● 149172		● 152053						
1/4	20	8	90	18	29	8	6.2	3	6.7	● 149284	● 149286	* 152073	● 152074						
5/16	18	9.77	100	20	33	10	8	3	8.4		* 149360								

EG UNF ASME B18.29.1



HSSE

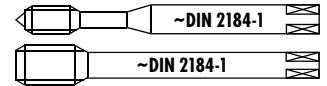

											N320-4	N420-4	N360-3	N460-3
N320-4		62 63 64 72 73 74 81 91												
N420-4		62 63 64 72 73 74 81 91												
N360-3		63 72 73 74 81 91												
N460-3		63 72 73 74 81 91												
Ø" d ₁ EG UNF	P TPI	d ₁ mm	l ₁ mm	l ₂ mm	l ₃ mm	d ₂ mm	a mm			ID	ID	ID	ID	
6	40	4.33	63	14	21	4.5	3.4	3	3.7	● 118879				
8	36	5.08	70	15	25	6	4.9	3	4.4	● 118882				
10	32	5.85	80	17	30	6	4.9	3	5.1	● 104941				
1/4	28	7.52	90	20	35	8	6.2	3	6.65	● 110234				
5/16	24	9.31	90	20	35	9	7	3	8.2	● 118876				
3/8	24	10.89	100	19		8	6.2	3	9.8		● 118873			
1/2	20	14.35	100	24		11	9	3	13.1		● 118865			
Ø" d ₁ EG UNF	P TPI	d ₁ mm	l ₁ mm	l ₂ mm	l ₃ mm	d ₂ mm	a mm			ID	ID	ID	ID	
6	40	4.33	63	7.5	21	4.5	3.4	3	3.7	● 110959				
8	36	5.08	70	9	25	6	4.9	3	4.4	● 110960				
10	32	5.85	80	11	30	6	4.9	3	5.1	● 104946				
1/4	28	7.52	90	12.5	35	8	6.2	3	6.65	● 110020				
5/16	24	9.31	90	12.5	35	9	7	3	8.2	● 111619				
3/8	24	10.89	100	19		8	6.2	3	9.8		● 110027			
1/2	20	14.35	100	14		11	9	3	13.1		● 104951			

EG UNF ASME B18.29.1



PM

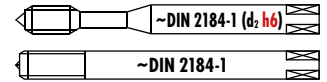

										Z370VS-3	S320VS-4	S360VS-3	SA390-3
Z370VS-3		VS		14	15	21	22	23	24				
Z370VS-3		VS		13	14	15	21	22	23				
S320VS-4		VS		13	15	16	22	23	24				
S360VS-3		VS		13	15	16	22	23	24				
SA390-3		aero		16	53								
										3B	3B	3B	3B
$\emptyset'' d_1$ EG UNF	P TPI	d_1 mm	l_1 mm	l_2 mm	l_3 mm	d_2 h6 mm	a mm			ID			
10	32	5.85	80	11	30	6	4.9	3	5.1	● 165129			
1/4	28	7.52	90	12.5	35	8	6.2	3	6.65	● 165130			
5/16	24	9.31	90	12.5	35	* 8	* 6.2	3	8.2	● 165131			
* Norme DC / * DC Norm/ * Norma DC													
$\emptyset'' d_1$ EG UNF	P TPI	d_1 mm	l_1 mm	l_2 mm	l_3 mm	d_2 mm	a mm			ID			
10	32	5.85	80	17	30	6	4.9	3	5.1	● 111821			
1/4	28	7.52	90	20	35	8	6.2	3	6.65	● 111822			
5/16	24	9.31	90	20	35	9	7	3	8.2	● 111823			
$\emptyset'' d_1$ EG UNF	P TPI	d_1 mm	l_1 mm	l_2 mm	l_3 mm	d_2 mm	a mm			ID			
10	32	5.85	80	11	30	6	4.9	3	5.1	● 111811			
1/4	28	7.52	90	12.5	35	8	6.2	3	6.65	● 111812			
5/16	24	9.31	90	12.5	35	9	7	3	8.2	● 111824			
$\emptyset'' d_1$ EG UNF	P TPI	d_1 mm	l_1 mm	l_2 mm	l_3 mm	d_2 mm	a mm			ID			
10	32	5.85	80	20		6	4.9	3	5.1	● 149702			
1/4	28	7.52	90	25		8	6.2	3	6.65	● 149724			



PM

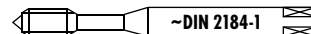

aero

SA320-4



15 16 52 64

SA350-3



15 16 52 64

TL351VS-3



41 42

SA320-4

SA350-3

TL351VS-3



< 1.5 x D

< 2 x D



< 2 x D

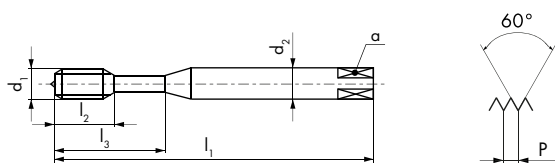

4 x P

2.5 x P

2.5 x P



3B

3B

3B

Ø" d ₁ EG UNF	P TPI	d ₁ mm	l ₁ mm	l ₂ mm	l ₃ mm	d ₂ mm	a mm		
10	32	5.85	80	15	23	6	4.9	3	5.1
1/4	28	7.52	90	18	29	8	6.2	3	6.65
5/16	24	9.31	90	20	31	9	7	3	8.2

ID

ID

ID

● 149190	● 149192	● 148008
● 146099	● 149268	● 148014
● 149336	● 149338	● 148021

Généralités

Le taraud couronne DC avec traitement de surface "V" est un outil de haut rendement réalisant des tolérances de filetage précises et une très bonne qualité de surface du taraudage.

Champs d'application

Grâce à un évidement sur la partie frontale qui permet de loger les copeaux, le taraud couronne peut être utilisé aussi bien pour les trous débouchants que les trous borgnes. Son champ d'application se situe dans des matières avec une résistance jusqu'à 850 N/mm² et un allongement maximum de 30%.

Utilisation

Pour un filetage correct dans des trous borgnes, il est impératif d'adapter la profondeur de l'avant-trou et de suivre les instructions suivantes :

- tarauder jusqu'à ce que la friction de l'appareil à tarauder patine
- ressortir le taraud et enlever les copeaux
- terminer le filetage jusqu'au fond du trou.

Exigences

Le fonctionnement correct du taraud couronne DC ainsi que la qualité du filetage dépendent des points suivants :

- de l'erreur de centrage qui ne doit pas excéder 0.1 mm
- de l'utilisation d'un appareil à tarauder adéquat qui permettra au taraud de tourner parfaitement rond
- d'une vitesse de coupe correcte
- d'une huile de coupe adaptée à la matière
- d'une parfaite fixation de l'outil dans un porte-outils muni d'une compensation axiale et d'un embrayage de sécurité
- d'un réglage de l'embrayage sur une position supérieure à celle du couple de travail.

Lors du premier filetage, il est recommandé de desserrer l'embrayage, puis de le resserrer progressivement jusqu'à ce que le taraud soit entraîné.

Copeaux

La capacité d'accumulation des copeaux dans l'évidement est la suivante :

Filetages	Ø 20 - 29 mm	≥ Ø 30 mm
M	-	1.4 x D
MF	1.2 x D	1.4 x D
UN-8	-	1.4 x D
G	1.2 x D	1.4 x D

Generalità

Il maschio a corona DC con trattamento superficiale "V" è un utensile di alto rendimento che permette di realizzare filettature con tolleranze precise ed una eccellente qualità superficiale.

Campi d'impiego

Grazie alla camera interna, che consente di raccogliere i trucioli, il maschio a corona può essere utilizzato per la realizzazione di fori passanti e fori ciechi. Il suo campo d'applicazione copre i materiali con resistenza sino a 850 N/mm² e con allungamento massimo pari al 30%.

Impiego

Per un corretto impiego nei fori ciechi, è necessario adattare la profondità del preforo e seguire le seguenti istruzioni:

- maschiare sino a quando la frizione del maschiatore slitta
- ritirare il maschio e togliere i trucioli
- terminare la filettatura sino al fondo del foro.

Esigenze

Il corretto funzionamento del maschio a corona DC, nonché la qualità della filettatura, dipendono dai seguenti punti:

- l'errore di centraggio non deve superare 0.1 mm
- impiegare un maschiatore di qualità che permetta al maschio di girare perfettamente tondo
- utilizzare una velocità di taglio corretta
- impiegare un olio da taglio specifico per il materiale
- bloccare il maschio in un porta-utensile con compensazione assiale e frizione di sicurezza
- regolare la frizione ad un valore di slittamento superiore a quello della coppia di lavoro.

Durante la prima filettatura, allentare la frizione, quindi serrarla progressivamente sino a quando il maschio è trascinato.

Trucioli

La capacità di accumulo dei trucioli nella camera anteriore è la seguente:

Filettature	Ø 20 - 29 mm	≥ Ø 30 mm
M	-	1.4 x D
MF	1.2 x D	1.4 x D
UN-8	-	1.4 x D
G	1.2 x D	1.4 x D

Vitesse de coupe et tours/min (indicatives) - Velocità di taglio e giri/min (valori indicativi)

M	P	V _c (m/min)	n ⁿ (U/min)	MF	P	V _c (m/min)	n ⁿ (U/min)	MF	P	V _c (m/min)	n ⁿ (U/min)	UN-8	P TPI	V _c (m/min)	n ⁿ (U/min)
30	3.5	7.9	84	22	1.5	8.0	116	45	1.5	6.9	49	1/4"	8	7.8	77
33	3.5	7.7	74	24	1.5	8.0	106	45	2.0	6.9	49	3/8"	8	7.6	69
36	4.0	7.5	66	26	1.5	7.9	97	48	1.5	6.6	44	1/2"	8	7.3	62
39	4.0	7.3	60	28	1.5	7.9	90	48	2.0	6.6	44	5/8"	8	7.1	55
42	4.5	7.1	54	30	1.5	7.9	84	48	3.0	6.6	44	3/4"	8	6.9	49
45	4.5	6.9	49	30	2.0	7.9	84	48	4.0	6.6	44	7/8"	8	6.7	45
48	5.0	6.6	44	32	1.5	7.8	77	50	1.5	6.5	41	2"	8	6.4	40
52	5.0	6.4	39	32	2.0	7.8	77	52	1.5	6.4	39	2 1/8"	8	6.4	38
56	5.5	6.1	35	33	1.5	7.7	74	52	3.0	6.4	39	2 1/4"	8	6.1	34
60	5.5	5.8	31	33	2.0	7.7	74	55	1.5	6.2	36	2 1/2"	8	5.6	28
64	6.0	5.5	28	34	1.5	7.6	71	56	4.0	6.1	35				
68	6.0	5.2	25	35	1.5	7.6	69	60	2.0	5.8	31				
				36	1.5	7.5	66	64	4.0	5.5	28				
				36	2.0	7.5	66	68	4.0	5.2	25				
				36	3.0	7.5	66	72	6.0	5.0	22				
				38	1.5	7.3	62	76	6.0	4.7	20				
				40	1.5	7.2	57	80	2.0	4.4	18				
				40	2.0	7.2	57	80	4.0	4.4	18				
				42	1.5	7.1	54	80	6.0	4.4	18				
				42	2.0	7.1	54	90	6.0	3.7	13				
				42	3.0	7.1	54	100	6.0	3.0	10				
				42	4.0	7.1	54	110	6.0	2.5	7				
												G	P TPI	V_c (m/min)	n (U/min)
												3/4"	14	7.9	95
												1"	11	7.7	74
												1 1/4"	11	7.1	54
												1 1/2"	11	6.6	44
												1 3/4"	11	6.3	37
												2"	11	5.8	31

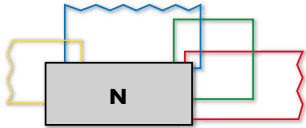



N470V-4

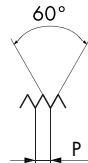
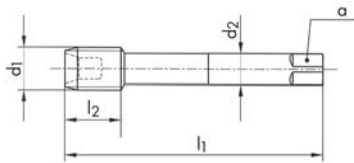

11 12 13 14 21 32

N470V-4



$\emptyset d_1$ M	P mm	l_1 mm	l_2 mm	d_2 mm	a mm			ID
30	3.5	180	39	22	18	5	26.5	● 102575
33	3.5	180	39	22	18	5	29.5	★ 102576
36	4	200	43	25	20	5	32	● 102577
39	4	200	43	25	20	5	35	● 102578
42	4.5	220	47	28	22	5	37.5	● 102579
45	4.5	220	47	28	22	5	40.5	● 102580
48	5	240	52	32	24	5	43	● 102581
52	5	240	52	32	24	5	47	● 102582
56	5.5	260	58	36	29	6	50.5	● 102583
60	5.5	260	58	36	29	6	54.5	● 102584
64	6	290	64	40	32	6	58	● 102585
68	6	290	64	40	32	6	62	★ 102586

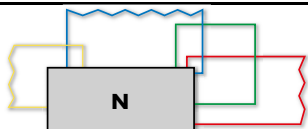



N470V-3

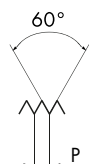
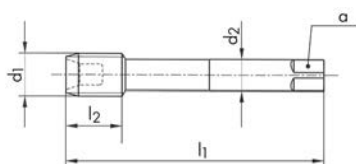

11 12 13 14 21 32

N470V-3



Ø d ₁ MF	P mm	l ₁ mm	l ₂ mm	d ₂ mm	a mm			ID
△22	1.5	125	28	18	14.5	4	20.5	* 102526
△26	1.5	140	30	18	14.5	4	24.5	* 102529
△28	1.5	140	30	20	16	4	26.5	* 102530
30	1.5	160	32	22	18	5	28.5	* 102531
34	1.5	160	26	22	18	5	32.5	* 102537
35	1.5	175	28	25	20	5	33.5	* 102538
36	2	175	35	25	20	5	34	● 102540
36	3	200	43	25	20	5	33	● 102541
38	1.5	175	28	25	20	5	36.5	* 102542
40	2	190	38	28	22	5	38	* 102544
42	2	190	38	28	22	5	40	● 102546
42	3	220	47	28	22	5	39	● 102547
48	1.5	205	34	32	24	5	46.5	* 102551
48	3	205	41	32	24	5	45	● 102553
52	3	205	41	32	24	5	49	● 102557
56	4	260	58	36	29	6	52	● 102559
64	4	290	64	40	32	6	60	● 102561
80	4	270	56	45	35	7	76	* 102564



Other sizes from Ø 30 to 160 mm on request!



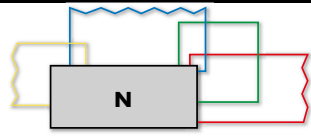

N470V-3

V

11 12 13 14 21 32

N470V-3

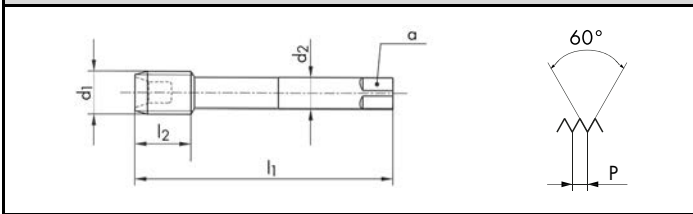
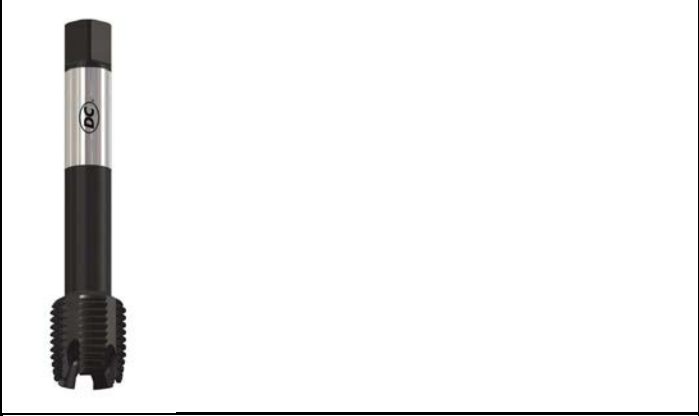

C
2.5 x P

2B

Ø" d ₁ UN	P TPI	d ₁ mm	l ₁ mm	l ₂ mm	d ₂ mm	a mm			ID
1 1/4	8	31.75	180	39	22	18	5	28.7	● 102566
1 3/8	8	34.92	180	39	22	18	5	31.8	● 102568
1 1/2	8	38.1	200	43	25	20	5	35	● 102565
1 5/8	8	41.27	220	47	28	22	5	38.2	● 102569
1 3/4	8	44.45	220	47	28	22	5	41.4	● 102567
1 7/8	8	47.62	240	52	32	24	5	44.5	● 102570
2	8	50.8	205	41	32	24	5	47.7	● 102572
2 1/8	8	53.97	205	41	32	24	5	50.9	★ 143542
2 1/4	8	57.15	220	45	36	29	6	54.1	● 102571
2 1/2	8	63.5	220	45	36	29	6	60.4	● 111879

ID
● 102566
● 102568
● 102565
● 102569
● 102567
● 102570
● 102572
★ 143542
● 102571
● 111879

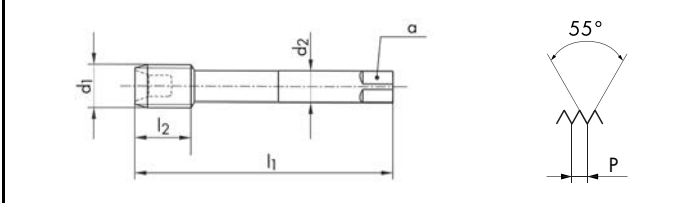

C
2.5 x P

Ø" d ₁ G	P TPI	d ₁ mm	l ₁ mm	l ₂ mm	d ₂ mm	a mm			ID
Δ 3/4	14	26.44	150	34	20	16	4	24.4	● 102525
1	11	33.24	160	32	22	18	5	30.7	● 102522
1 1/4	11	41.91	190	38	28	22	5	39.3	● 102519
1 1/2	11	47.8	205	41	32	24	5	45.2	● 102518
1 3/4	11	53.74	205	41	32	24	5	51.2	★ 102520
2	11	59.61	220	45	36	29	6	57	● 102524

Δ

FORETS-TARAUDEURS

Généralités

Le foret-taraudeur DC est un outil qui permet de percer et de tarauder une pièce en une seule opération sans changement d'outillage.

Son utilisation est idéale sur des machines CNC, des machines transfert, des tours revolver et des taraudeuses.

Champs d'application

Les matières aptes à être travaillées avec le foret-taraudeur DC, sont celles se situant jusqu'à 750 N/mm², dont les aciers, la fonte grise, la fonte grise ductile, le laiton et l'aluminium.

Exigences

- L'avant-trou doit être percé entièrement avant que le taraud commence son travail.
- Pour les matières à copeaux courts, la profondeur du taraudage ne doit pas excéder 1.8 x D (2 x D pour N5952).
- Pour les matières à copeaux longs, la profondeur du taraudage ne doit pas excéder 1.2 x D.
- La lubrification est identique à celle du taraudage.

Vitesses de coupe

Lorsque les machines le permettent, il est préférable de travailler aux vitesses de perçage et de taraudage appropriées (voir table de utilisation).

Sur les machines où les vitesses de perçage et de taraudage ne peuvent pas être variées, il est recommandé d'appliquer les valeurs indiquées dans le tableau ci-dessous.

Utilisation

Chanfreins :

Centrer et chanfreiner simultanément.

Programmation avec avance et rotation, 100% synchronisées (cas idéal) :

- 1) Placer le foret-taraudeur en accélérant jusqu'à sa position de travail.
- 2) Perçage :
 - régler les tours
 - régler l'avance
 - éviter les copeaux longs
 - éliminer les copeaux
- 3) Positionner le foret-taraudeur pour amorcer le filet
- 4) Taraudage :
 - régler la vitesse de taraudage
 - l'avance doit correspondre au 100% du pas
 - régler la profondeur
 - le taraud doit être libre de copeaux au moment de commencer le travail
- 5) Revenir avec l'outil à la position de départ

Programmation sans une synchronisation totale de l'avance et de la rotation :

Important : utiliser un mandrin avec ressort de compression bloqué et une extension axiale libre.

- 1) Placer le foret-taraudeur en accéléré à sa place de travail
- 2) Perçage :
 - régler les tours
 - régler l'avance
 - éviter les copeaux longs
 - éliminer les copeaux
- 3) Positionner le foret-taraudeur pour amorcer le filet
- 4) Taraudage :
 - régler la vitesse de taraudage
 - l'avance doit correspondre à 90 - 95% du pas
 - régler la profondeur du filetage
- 5) Revenir avec l'outil à la position de départ.

Vitesses de coupe et tours/min (indicatives)

Groupes de matières	Vc (m/min)	Ø et nombre de tours/min										
		M3	M4	M5	M6	M8	M10	M12	M14	M16	M18	M20
Aciers jusqu'à 500 N/mm ²	20	2120	1600	1270	1060	800	640	530	460	400	360	320
Aciers dès 500 N/mm ²	15	1600	1200	950	800	600	480	400	340	300	270	240
Fonte grise ductile	20	2120	1600	1270	1060	800	640	530	460	400	360	320
Fonte grise	15	1600	1200	950	800	600	480	400	340	300	270	240
Laiton	25	2650	2000	1600	1330	950	800	660	570	500	450	400
Aluminium	25	2650	2000	1600	1330	950	800	660	570	500	450	400

PUNTE MASCHIATRICI

Generalità

La punta maschiatrice DC è un utensile che permette di forare e maschiare un pezzo in un'unica operazione senza cambio di utensile.

Il suo impiego è ideale con macchine CNC, transfert, torni revolver e maschiatrici.

Campi d'impiego

I materiali che si prestano ad essere lavorati con la punta maschiatrice DC, sono quelli sino a 750 N/mm² e pertanto: acciai da costruzione, ghisa grigia malleabile, ghisa grigia, ottone ed alluminio.

Esigenze

- Il preforo deve essere completamente eseguito prima che il maschio inizi a lavorare.
- Nei materiali a truciolo corto, la profondità del filetto non deve superare $1.8 \times D$ ($2 \times D$ con l'utensile N5952).
- Nei materiali a truciolo lungo, la profondità del filetto non deve superare $1.2 \times D$.
- La lubrificazione è identica a quella per la maschiatura.

Velocità di taglio

Quando le macchine lo consentono, è preferibile lavorare con velocità di foratura e maschiatura appropriata (vedere la tabella d'impiego).

Sulle macchine ove le velocità di foratura e maschiatura non possono essere variate, si raccomanda di applicare i valori indicati nella tabella sottoriportata.

Impiego

Smussi:

Centrare e smussare simultaneamente.

Programmazione con avanzamento e rotazione, 100% sincronizzati (caso ideale):

- 1) Posizionare la punta maschiatrice, in accelerazione, nel punto di lavoro
- 2) Foratura:
 - regolare il numero di giri
 - regolare l'avanzamento
 - evitare i trucioli lunghi
 - eliminare i trucioli
- 3) Posizionare la punta maschiatrice per iniziare il filetto
- 4) Maschiatura:
 - regolare la velocità
 - avanzamento = 100% del passo
 - regolare la profondità della filettatura
- 5) Ritornare con la punta maschiatrice alla posizione di partenza.

Programmazione senza sincronizzazione totale dell'avanzamento e della rotazione:

Importante: utilizzare un maschiatore con molla di compressione bloccata ed estensione assiale libera.

- 1) Posizionare la punta maschiatrice, in accelerazione, nel punto di lavoro
- 2) Foratura:
 - regolare il numero di giri
 - regolare l'avanzamento
 - evitare i trucioli lunghi
 - eliminare i trucioli
- 3) Posizionare la punta maschiatrice per iniziare il filetto
- 4) Maschiatura:
 - regolare la velocità
 - avanzamento = 90 - 95% del passo
 - regolare la profondità della filettatura
- 5) Ritornare con la punta maschiatrice alla posizione di partenza.

Velocità di taglio e giri/min (valori indicativi)

Gruppi di materiali	Vc (m/min)	Ø e numero di giri/min										
		M3	M4	M5	M6	M8	M10	M12	M14	M16	M18	M20
Acciai < 500 N/mm ²	20	2120	1600	1270	1060	800	640	530	460	400	360	320
Acciai > 500 N/mm ²	15	1600	1200	950	800	600	480	400	340	300	270	240
Ghisa grigia malleabile	20	2120	1600	1270	1060	800	640	530	460	400	360	320
Ghisa grigia	15	1600	1200	950	800	600	480	400	340	300	270	240
Ottone	25	2650	2000	1600	1330	950	800	660	570	500	450	400
Alluminio	25	2650	2000	1600	1330	950	800	660	570	500	450	400

M, MF ISO DIN 13

HSSE

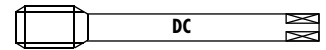

								N5951	N5952	N5951	
N5951											
N5952											
N5951											
								ISO 2 6H	ISO 2 6H	7H EN 60423	
$\emptyset d_1$ M	P mm	l_{11} mm	l_2 mm	d_2 mm	a mm	d_{10} mm	l_{10} mm	ID			
3	0.5	62	12.5	3.5	2.7	2.55	9	● 104578			
4	0.7	66	16	4.5	3.4	3.36	10	● 104580			
5	0.8	75.5	18	6	4.9	4.26	12.5	● 104583			
6	1	81	20	6	4.9	5.05	14	● 104585			
8	1.25	93	12	6	4.9	6.8	20	● 104588			
10	1.5	99	14	7	5.5	8.55	22	● 104571			
12	1.75	106	16	9	7	10.3	25	● 104573			
16	2	123	20	12	9	14.1	32	● 104576			
20	2.5	132	22	16	12	17.6	36	● 104577			
$\emptyset d_1$ M	P mm	l_{11} mm	l_2 mm	d_2 mm	a mm	d_{10} mm	l_{10} mm	ID			
4	0.7	77	16	4.5	3.4	3.36	21	● 104608			
5	0.8	87	18	6	4.9	4.26	24	● 104609			
6	1	94	20	6	4.9	5.05	27	● 104610			
8	1.25	109	12	6	4.9	6.8	36	● 104611			
10	1.5	118	14	7	5.5	8.55	41	● 104603			
$\emptyset d_1$ MF	P mm	l_{11} mm	l_2 mm	d_2 mm	a mm	d_{10} mm	l_{10} mm	ID			
4	0.5	66	16	4.5	3.4	3.55	10	★ 104579			
5	0.75	75.5	18	6	4.9	4.31	12.5	★ 123379			
8	1	93	12	6	4.9	7.05	20	● 104587			
10	1	99	14	7	5.5	9.05	22	● 104570			
$\emptyset d_1$ MF	P mm	l_{11} mm	l_2 mm	d_2 mm	a mm	d_{10} mm	l_{10} mm	ID			
12	1.5	106	16	9	7	10.55	25	● 142825			
16	1.5	123	16	12	9	14.55	32	● 142826			
20	1.5	132	18	16	12	18.55	36	● 111844			
25	1.5	155	22	18	14.5	23.55	45	● 111845			
32	1.5	170	24	22	18	30.55	50	● 111846			

UNC ASME B1.1

G DIN EN ISO 228

PG DIN 40430

HSSE

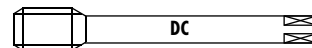

N5951

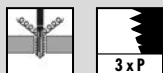

N5951



2B

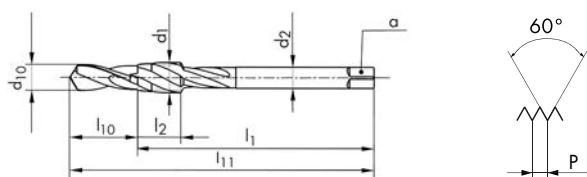

$\emptyset'' d_1$ UNC	P TPI	d_1 mm	l_{11} mm	l_2 mm	d_2 mm	a mm	d_{10} mm	l_{10} mm
6	32	3.5	66	16	4	3	2.8	10
10	24	4.82	75.5	18	4.5	3.4	3.86	12.5
1/4	20	6.35	81	20	7	5.5	5.15	14
1/2	13	12.7	106	16	9	7	10.85	25

ID

- ★ 104601
- 104598
- 104597
- ★ 104596

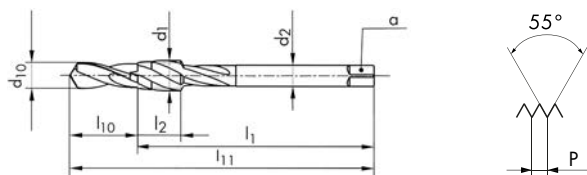

$\emptyset'' d_1$ G	P TPI	d_1 mm	l_{11} mm	l_2 mm	d_2 mm	a mm	d_{10} mm	l_{10} mm
1/8	28	9.72	93	12	7	5.5	8.75	20
1/4	19	13.15	106	14	11	9	11.75	25
3/8	19	16.66	123	16	12	9	15.25	32
1/2	14	20.95	132	18	16	12	19	36

ID

- 104567
- 104566
- 104569
- 104565

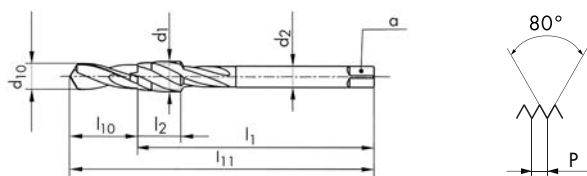

$\emptyset d_1$ PG	P TPI	d_1 mm	l_{11} mm	l_2 mm	d_2 mm	a mm	d_{10} mm	l_{10} mm
16	18	22.5	142	20	18	14.5	21.25	40
29	16	37	203	28	28	22	35.65	63

ID

- 104591
- 104593

TARAUDAGE PAR DÉFORMATION MASCHIATURA PER DEFORMAZIONE

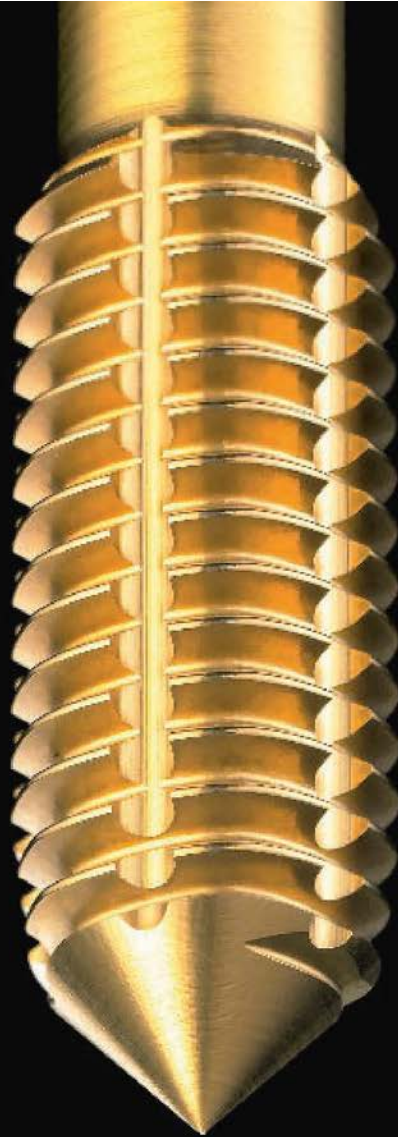

SUR DEMANDE

Exécutions spéciales avec des lobes de polygone adaptés pour des applications spécifiques.

SU RICHIESTA

Esecuzioni speciali con lobi poligonali adattati per applicazioni specifiche.

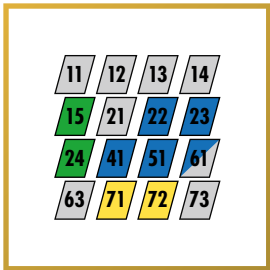

Domaines d'application

Toutes les matières ayant un coefficient d'allongement égal ou supérieur à 10% et une résistance à la traction jusqu'à 1'150 N/mm², p.ex. aciers, aciers inoxydables, titane pur, aluminium, cuivre, laitons à copeaux longs.

Campi di applicazione

Per tutti i materiali aventi un coefficiente d'allungamento uguale o superiore al 10 % ed una resistenza alla trazione fino a 1'150 N/mm², per esempio acciai, acciai inossidabili, titanio puro, alluminio, rame, ottone a trucioli lunghi.

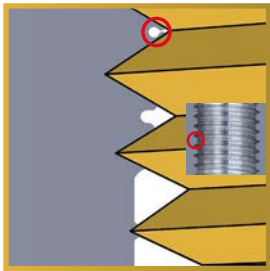

Procédé de formation

Les pointes et flancs des dents du refouleur pénètrent dans la pièce à déformer et poussent la matière dans les évidements du profil de l'outil. Ainsi se forme le profil typique du filetage avec le sillon à son extrémité.

Processo di formazione

Le punte e i fianchi dei denti da rullare penetrano nel pezzo da deformare e spingono il materiale nella scanalatura del profilo dell'utensile. Si forma così il profilo tipico della filettatura con il solco sull'estremità.

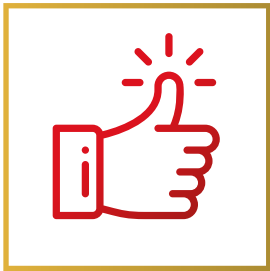

Avantages

- Sécurité du processus accrue, suite à l'absence de copeaux.
- Un seul outil pour trous borgnes et débouchants.
- Idéal pour taraudages profonds.
- Taraudage avec une plus grande résistance à l'éirement statique et dynamique.

Vantaggi

- Alta sicurezza del processo dovuta all'assenza di trucioli.
- Un solo utensile per fori ciechi e passanti.
- Ideale per maschiatura profonda.
- Filetti con maggior resistenza alla trazione statica e dinamica.



Limite d'utilisation

Pour des raisons physiques, le taraudage par déformation sur des pièces à faible paroi n'est possible qu'en prenant toutes les précautions nécessaires.

Limite di applicazione

È bene prestare la massima attenzione nel caso della maschiatura per deformazione in pezzi a parete sottile per ovvie ragioni fisiche.



Bien lubrifier

Le refoulement de la matière occasionne d'importantes forces de frottement, c'est pourquoi le taraud doit être protégé par un film d'huile. La déchirure de ce dernier provoque des soudures froides pouvant conduire à la rupture de l'outil.

Adeguata lubrificazione

La rullatura del materiale genera importanti forze di attrito. Per questo motivo l'utensile deve essere protetto attraverso una pellicola lubrificata. L'interruzione di quest'ultima provoca saldature fredde che possono condurre alla rottura dell'utensile.

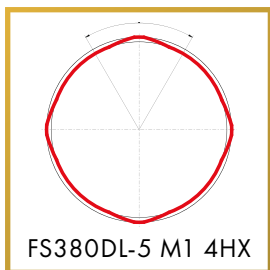

FS380DL-5 M1 4HX

Taraud à refouler FS-DL

Taraud à refouler universel à 4 lobes pour petits filetages de $\varnothing \geq 1 - < 3$ mm pour toutes les matières déformables à froid. Avec revêtement "DLC" ayant de bonnes propriétés de glissement et d'autolubrification. Pour aciers inoxydables, cuivre pur, etc.

Maschio a rullare FS-DL

Maschio a rullare universale a 4 lobi per piccole filettature da $\varnothing \geq 1 - < 3$ mm per tutti i materiali deformabili a freddo. Con rivestimento "DLC" si hanno eccellenti proprietà di scorrimento ed autolubrificazione. Per acciai inox, rame puro, ecc.

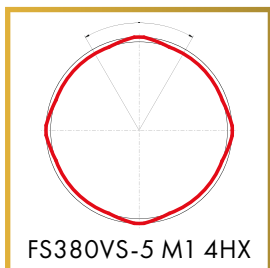

FS380VS-5 M1 4HX

Taraud à refouler FS-VS

Taraud à refouler universel à 4 lobes pour petits filetages de $\varnothing \geq 1 - < 3$ mm pour toutes les matières déformables à froid. Avec revêtement DC "VS" pour un meilleur glissement et protection contre l'usure.

Maschio a rullare FS-VS

Maschio a rullare universale a 4 lobi per piccole filettature da $\varnothing \geq 1 - < 3$ mm per tutti i materiali deformabili a freddo. Con rivestimento DC "VS" per uno scorrimento migliore e protezione contro l'usura.

NEW

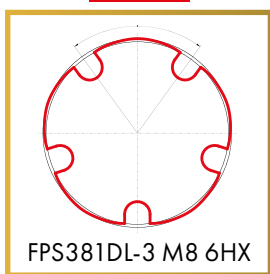

FPS381DL-3 M8 6HX

Taraud à refouler FPS-DL

Pour $\varnothing \geq 3$ mm, avec lobes de contact arrondis, conçus pour un fluage progressif de matières abrasives. Avec revêtement "DLC" offrant un meilleur glissement et une durée de vie élevée dans le laiton à copeaux longs et l'aluminium.

Maschio a rullare FPS-DL

Per $\varnothing \geq 3$ mm, con lobi di contatto arrotondati, concepito per uno scorrimento progressivo dei materiali abrasivi. Con rivestimento "DLC" abbiamo uno scorrimento migliore ed una durata dell'utensile elevata nell'ottone a trucioli lunghi e nell'alluminio.

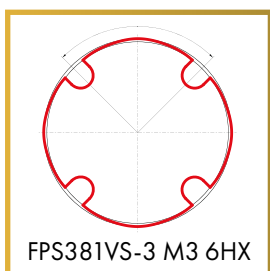

FPS381VS-3 M3 6HX

Taraud à refouler FPS-VS

Pour $\varnothing \geq 3$ mm, avec lobes de contact arrondis, conçus pour un fluage progressif de matières à faible coefficient d'allongement. Avec revêtement "VS" ayant une grande résistance à l'usure et une stabilité thermique et chimique à haute température. Pour aciers de construction, au carbone, alliées, etc.

Maschio a rullare FPS-VS

Per $\varnothing \geq 3$ mm, con lobi di contatto arrotondati, concepito per uno scorrimento progressivo dei materiali con debole coefficiente d'allungamento. Il rivestimento "VS" offre una maggior resistenza all'usura e una stabilità termica e chimica ad alte temperature. Per acciai da costruzione, al carbonio, leghe, ecc.

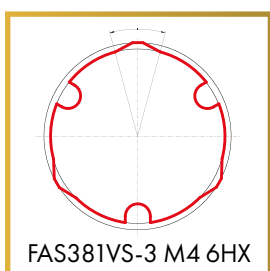

FAS381VS-3 M4 6HX

Taraud à refouler FAS-VS

Pour $\varnothing \geq 3$ mm, avec lobes de contact saillants, conçus pour un fluage rapide de matières tenaces à haut coefficient d'allongement. Avec revêtement "VS" ayant de bonnes propriétés de glissement et d'autolubrification. Pour aciers inoxydables, cuivre pur, etc.

Maschio a rullare FAS-VS

Per $\varnothing \geq 3$ mm, con lobi di contatto sporgenti, concepito per uno scorrimento rapido dei materiali tenaci ad alto coefficiente d'allungamento. Con rivestimento "VS" si hanno eccellenti proprietà di scorrimento ed autolubrificazione. Per acciai inox, rame puro, ecc.

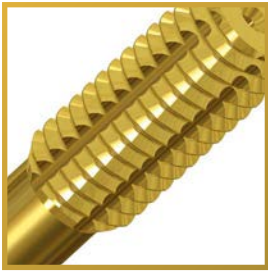

Rainures de lubrification dès Ø 3 mm

Le lubrifiant est guidé vers les surfaces de l'outil se trouvant directement en contact avec la matière.

Scanalature di lubrificazione da Ø 3 mm

Il lubrificante è guidato verso le superfici dell'utensile trovandosi direttamente in contatto con il materiale.



Sans rainures de lubrification

Particulièrement recommandés pour des matières tendres et des trous débouchants dans de la tôle.

Senza scanalature di lubrificazione

Particolarmente raccomandati per materiali teneri e per fori passanti in lamiera di debole spessore.



Avec lubrification intérieure

Fortement conseillé pour les trous profonds et le travail en horizontal.

Con lubrificazione interna

Fortemente consigliato per i fori profondi e lavorazioni in orizzontale.

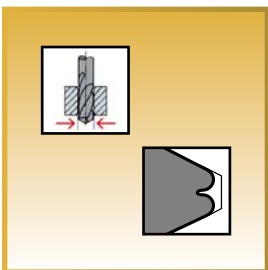

Profil de filetage correct

Un avant-trou précis est requis pour réaliser un filetage conforme à la norme. Pour les matières présentant un fort coefficient d'allongement ou lors de taraudage $> 2 \times D$, un Ø d'avant-trou plus grand de 0.02 à 0.05 mm est conseillé.

Profilo corretto di maschiatura

Un preforo preciso è richiesto per realizzare una filettatura conforme alle norme. Per i materiali che presentano un forte coefficiente d'allungamento al momento della maschiatura $> 2 \times D$, è consigliato un diametro del preforo più grande da 0.02 a 0.05 mm.

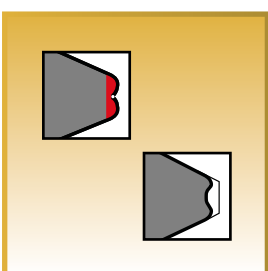

Profil incorrect

Profil trop grand suite à un diamètre de perçage trop petit, générant un couple trop élevé.

Profil incomplet suite à un diamètre de perçage trop grand.

Profilo non corretto

Profilo troppo grande dovuto ad un diametro di foratura troppo piccolo, genera una coppia troppo elevata.

Profilo incompleto conseguente ad un diametro di foratura troppo grande.

CODIFICATION – CODIFICAZIONE

DC Tarauds à refouler

DC Maschi a rullare

Exemple - Esempio



Polygone standard < Ø 3 mm	Poligono standard < Ø 3 mm	FS						
Polygone passif ≥ Ø 3 mm	Poligono passivo ≥ Ø 3 mm	FPS						
Polygone actif ≥ Ø 3 mm	Poligono attivo ≥ Ø 3 mm	FAS						
Exécution spéciale	Esecuzione speciale		3					
DIN longue - queue renforcée	DIN lungo - gambo rinforzato			3				
DIN longue - queue passante	DIN lungo - gambo passante			4				
DIN extra-longue - queue renforcée	DIN extra-lungo - gambo rinforzato			5				
DIN extra-longue - queue passante	DIN extra-lungo - gambo passante			6				
Taraud à refouler	Maschi a rullare				8			
Sans rainures de lubrification	Senza scanalature di lubrificazione					0		
Avec rainures de lubrification	Con scanalature di lubrificazione					1		
Canal de lubrification, sorties radiales	Canale di lubrificazione, uscite radiali					4		
Protection "VS" pour utilisation générale	Protezione antiusura "VS" per uso generale						VS	
Revêtement DLC	Rivestimento DLC						DL	
2 - 3 filets d'entrée	2 - 3 filetti d'imbocco							-3
1.5 - 2 filets d'entrée	1.5 - 2 filetti d'imbocco							-5

PICTOGRAMMES – SIMBOLI



Pour groupes matières selon table de utilisation
 Per gruppi di materiali secondo tabella d'impiego

12	
1.0037	Si37-2 (S235JR)
1.0050	Si50-2 (E295)
1.0060	Si60-2 (E335)
1.5919	15CrNi6
1.7131	16MnCr5

22	
1.4301	X5CrNi18-10
1.4406	X2CrNiMoN17-12-2
1.4435	X2CrNiMo18-14-3
1.4541	X6CrNiTi18-10
1.4571	X6CrNiMoTi17-12-2

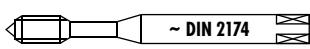

Queue renforcée selon ~ DIN 2174
 Gambo rinforzato, secondo ~ DIN 2174

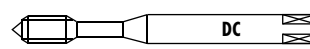

Queue renforcée selon norme DC
 Gambo rinforzato, secondo norma DC



Queue passante selon ~ DIN 2174
 Gambo passante, secondo ~ DIN 2174

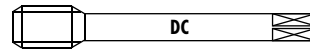

Queue passante selon norme DC
 Gambo passante, secondo norma DC



Extra-longue
 Extra-lungo



HSSE-PM
 HSSE-PM



Tarauts à refouler
 Maschi a rullare



Tarauts à refouler avec rainures de lubrification
 Maschi a rullare con scanalature di lubrificazione



Lubrification intérieure avec sortie frontale, sur demande
 Lubrificazione interna con uscita frontale, su richiesta



Lubrification intérieure avec sorties radiales à 45°
 Passage à la nouvelle version en cours
 Lubrificazione interna con uscite radiali a 45°
 In corso il passaggio alla nuova versione



Diamètre d'avant-trou
 Prefori



Filetage à gauche
 Filettatura sinistra



2 - 3 filets d'entrée, forme C
 2 - 3 filetti d'imbocco, forma C



1.5 - 2 filets d'entrée, forme E
 1.5 - 2 filetti d'imbocco, forma E



Classe de tolérance ISO 2 6HX
 Classe di tolleranza ISO 2 6HX



Classe de tolérance ISO 3 6GX
 Classe di tolleranza ISO 3 6GX



Trou traversant / borgne < 1 x D
 Foro passante / cieco < 1 x D



Trou traversant / borgne < 1.5 x D
 Foro passante / cieco < 1.5 x D



Trou traversant / borgne < 2.5 x D
 Foro passante / cieco < 2.5 x D



Trou traversant / borgne > 2.5 x D
 Foro passante / cieco > 2.5 x D



Trou traversant / borgne < 3 x D
 Foro passante / cieco < 3 x D



Revêtement DLC
 Rivestimento DLC



Protection contre l'usure "VS" pour utilisation générale
 Protezione antiusura "VS" per uso generale



Pour taraudage synchrone
 Per maschiatura sincrona



Pour taraudage classique
 Per maschiatura classica



Article en stock
 Articoli in stock



Disponible à court terme
 Disponibile a breve



Disponible jusqu'à épuisement du stock
 Articoli disponibili sino ad esaurimento

TABELLE D'UTILISATION — TABELLA D'IMPIEGO

Taroudage par déformation Maschiatura per deformazione

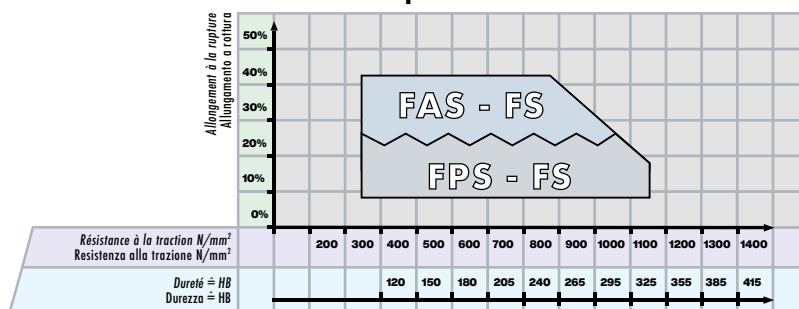

DC Classification des matières

DC Classificazione dei materiali

Groupes de matières Gruppi di materiali	Désignation des matières	Designazione dei materiali	Dureté Durezza (HB)	Résistance Resistenza Rm (N/mm²)	Allongement Allungamento A (%)
10 Aciers Acciai	11 Aciers de décolletage	Acciai da tornitura	< 200	< 700	< 10
	12 Aciers de construction ou de cémentation	Acciai da costruzione / da cementazione	< 200	< 700	< 30
	13 Aciers au carbone	Acciai al carbonio	< 300	< 1000	< 20
	14 Aciers alliés < 850 N/mm²	Acciai legati < 850 N/mm²	< 250	< 850	< 30
	15 Aciers alliés / traités > 850 - < 1150 N/mm²	Acciai legati / trattati > 850 - < 1150 N/mm²	> 250	> 850	< 30
	16 Aciers haute résistance ≤ 44 HRC	Acciai ad alta resistenza ≤ 44 HRC	> 250	> 850	< 12
	17 Aciers améliorés > 44 - ≤ 54 HRC	Acciai bonificati > 44 - ≤ 54 HRC	> 410	> 1400	< 2
	18 Aciers trempés > 54 - ≤ 63 HRC	Acciai temprati > 54 - ≤ 63 HRC	> 560	> 1980	< 2
20 Aciers inoxydables Acciai inox	21 Aciers inoxydables, soufrés	Acciai inox, allo zolfo	< 250	< 850	< 25
	22 Austénitiques	Acciai inox, austenitici	< 250	< 850	> 20
	23 Ferritiques et martensitiques < 850 N/mm²	Ferritici e martensitici < 850 N/mm²	< 250	< 850	> 20
	24 Ferritiques et martensitiques > 850 - < 1150 N/mm²	Ferritici e martensitici > 850 - < 1150 N/mm²	> 250	> 850	> 15
30 Fonte Ghisa	31 Fonte grise	Ghisa grigia	< 250	< 850	< 10
	32 Fonte à graphite sphéroïdale et malléable	Ghisa grafitica sferoidale e malleabile	< 250	< 850	> 10
40 Titane Titanio	41 Titane pur	Titanio puro	< 250	< 850	> 20
	42 Alliage de titane	Leghe di titanio	> 250	> 850	< 20
50 Nickel Nickel	51 Alliage de nickel 1 ≤ 850 N/mm²	Leghe di nickel 1 ≤ 850 N/mm²	< 250	< 850	> 25
	52 Alliage de nickel 2 > 850 - ≤ 1150 N/mm²	Leghe di nickel 2 > 850 - ≤ 1150 N/mm²	> 250	> 850	< 25
	53 Alliage de nickel 3 > 1150 - ≤ 1600 N/mm²	Leghe di nickel 3 > 1150 - ≤ 1600 N/mm²	> 340	> 1150	< 20
60 Cuivre Rame	61 Cuivre pur (électrolytique)	Rame puro (elettrolitico)	< 120	< 400	> 12
	62 Laiton, bronze (copeaux courts)	Ottone, bronzo (trucioli corti)	< 200	< 700	< 12
	63 Laiton (copeaux longs)	Ottone (trucioli lunghi)	< 200	< 700	> 12
	64 Laiton sans plomb	Ottone senza piombo	< 220	< 700	> 15
70 Aluminium Magnésium Alluminio Magnesio	71 Al non allié	Alluminio non legato	< 100	< 350	> 15
	72 Al allié Si < 1.5 %	Leghe di alluminio Si < 1.5 %	< 150	< 500	> 15
	73 Al allié Si > 1.5 % - < 10 %	Leghe di alluminio Si > 1.5 % - < 10 %	< 120	< 400	< 15
	74 Al allié Si > 10 %, alliages de magnésium	Leghe di al. Si > 10 %, leghe di magnesio	< 120	< 400	< 10
80 Matières plastiques Materie plastiche	81 Matières thermoplastiques	Materie termoplastiche	-	-	-
	82 Matières duroplastiques	Materie termoindurenti	-	-	-
	83 Matières plastiques renforcées par fibres	Materie plastiche rinforzate con fibre	-	-	-
90 Métaux précieux Metalli preziosi	91 Or jaune	Oro giallo	-	-	-
	92 Or rose	Oro rosso	-	-	-
	93 Or blanc	Oro bianco	-	-	-
	94 Argent	Argento	-	-	-

Optimale avec huile de coupe
Ottimale con olio da taglio

Fonctionnelle avec huile de coupe
Funzionale con olio da taglio

Optimale avec émulsion
Ottimale con emulsione

Fonctionnelle avec émulsion
Funzionale con emulsione

TARAUDAGE PAR DÉFORMATION MASCHIATURA PER DEFORMAZIONE

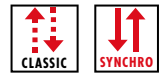

Dès page :
Dalla pagina:

M
MF
UNC
UNF
G

FS		FPS					FAS		
254	255	256	256	256	256	258	259	259	260
						262		262	
263						263		263	
264						264		264	
						265		265	

FS.80VS	FS.80DL	FPS.80DL	FPS.81DL	FPS.80VS	FPS.81VS	FPS.84VS	FAS.80VS	FAS.81VS	FAS.84VS

V_c
(m/min)
Guide Line
Ø 1 - 2.8 mm Ø 2.8 - 20 mm

--	--	--	--	--	--	--	--	--	--

11	12 - 20	20 - 40
12	12 - 20	20 - 40
13	12 - 20	20 - 30
14	12 - 20	20 - 30
15	6 - 12	10 - 15
16		
17		
18		
21	12 - 20	10 - 20
22	6 - 12	10 - 15
23	6 - 12	6 - 12
24	6 - 12	6 - 12
31		
32		
41	12 - 20	10 - 20
42		
51	6 - 12	10 - 15
52		
53		
61	12 - 20	10 - 20
62		
63	12 - 20	20 - 30
64	12 - 20	20 - 30
71	12 - 20	20 - 40
72	12 - 20	20 - 40
73	12 - 20	20 - 40
74		
81		
82		
83		
91	12 - 20	20 - 40
92	12 - 20	20 - 40
93	12 - 20	20 - 40
94	12 - 20	20 - 40

11
12
13
14
15
16
17
18
21
22
23
24
31
32
41
42
51
52
53
61
62
63
64
71
72
73
74
81
82
83
91
92
93
94

A Optimale avec air
Ottimale con aria

A Funzionelle avec air
Funzionale con aria

Limitée
Limitato









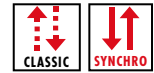













Les valeurs ci-dessus sont indicatives.
I valori sopracitati sono indicativi.



					FS				FPS			
Caractéristiques Caratteristiche					 		 		 		 	
Genre de trou Tipo di foro												
					FS380VS-5 FS380VS-3		FS380DL-5 FS380DL-3		FPS380DL-3 FPS381DL-3		FPS380VS-3 FPS381VS-3	
M	6HX	ISO DIN 13	<i>DIN longue</i> DIN lungo	~DIN 2174	254	255	256	256				
M	6GX	ISO DIN 13	<i>DIN longue</i> DIN lungo	~DIN 2174	254	255		256				
M	6HX	ISO DIN 13	<i>Extra-longue</i> Extra-lungo	DC								
MF	6HX	ISO DIN 13	<i>DIN longue</i> DIN lungo	~DIN 2174				262				
UNC	2BX	ASME B1.1	<i>DIN longue</i> DIN lungo	~DIN 2184-1	263			263				
UNF	2BX	ASME B1.1	<i>DIN longue</i> DIN lungo	~DIN 2184-1	264			264				
											FPS481VS-3	
M	6HX	ISO DIN 13	<i>DIN longue</i> DIN lungo	~DIN 2174				257				
M	6GX	ISO DIN 13	<i>DIN longue</i> DIN lungo	~DIN 2174								
M	6HX	ISO DIN 13	<i>Extra-longue</i> Extra-lungo	DC								
MF	6HX	ISO DIN 13	<i>DIN longue</i> DIN lungo	~DIN 2174				262				
UNC	2BX	ASME B1.1	<i>DIN longue</i> DIN lungo	~DIN 2184-1								
UNF	2BX	ASME B1.1	<i>DIN longue</i> DIN lungo	~DIN 2184-1								
G <small>(BSP)</small>		DIN EN ISO 228	<i>DIN longue</i> DIN lungo	~DIN 2189				265				

Répertoire — Tarauds à refouler
 Rubrica — Maschi a rollare



FPS			FAS			
 VS	 VS	 VS	 	 VS	 VS	 VS
			 			
						
FPS384VS-3	FPS581VS-3	FPS584VS-3	FAS380VS-3 FAS381VS-3	FAS384VS-3	FAS581VS-3	FAS584VS-3
258			259	260		
			259			
	257	258			261	261
			262			
			263			
			264			
FPS484VS-3	FPS681VS-3	FPS684VS-3	FAS481VS-3	FAS484VS-3	FAS681VS-3	FAS684VS-3
258			259	260		
			259			
	257	258			261	261
			262			
			265			

FS FORMING

FS380VS-5 VS 11 12 13 14
21

FS380VS-3 VS 11 12 13 14
21

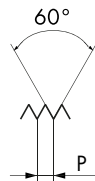
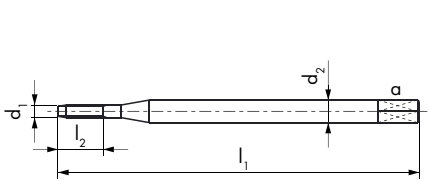
FS380VS-5
FS380VS-3
FS380VS-3
FS380VS-3

6HX
6HX
6HX
6GX

$\emptyset d_1$ M	P mm	l_1 mm	l_2 mm	d_2 mm	a mm	4HX Tol. 6HX
1	0.25	40	3	2.5		0.88 +0.02
1.2	0.25	40	3.6	2.5		1.08 +0.02
1.4	0.3	40	4.2	2.5		1.25 +0.02
1.6	0.35	40	4.8	2.5		1.45 +0.02
1.7	0.35	40	5.1	2.5		1.55 +0.02
1.8	0.35	40	5.4	2.5		1.65 +0.02
2	0.4	45	8	2.8	2.1	1.8 +0.02
2.5	0.45	50	10	2.8	2.1	2.3 +0.02
2.6	0.45	50	10	2.8	2.1	2.4 +0.02

ID
ID
ID
ID
6H
+ mm

- 157171
- 157172
- 157173
- 157174
- 157175
- 173452
- 173455
- 173458
- 169779
- 169782
- 169785
- 157176
- 157178
- 157179
- 157180 0.019
- 157181 0.020

 $\leq M1.5$
4HX

FS FORMING

FS380DL-5

FS380DL-3

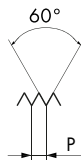
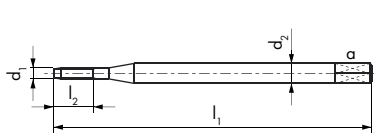
FS380DL-5
FS380DL-3
FS380DL-3
FS380DL-3

6HX
6HX
6HX
6GX

$\emptyset d_1$ M	P mm	l_1 mm	l_2 mm	d_2 mm	a mm	$\frac{4HX}{6HX}$ Tol.	ID	ID	ID	ID	6H + mm
1	0.25	40	3	2.5		0.88 +0.02	● 172839	● 173461			
1.2	0.25	40	3.6	2.5		1.08 +0.02	● 172840	● 173464			
1.4	0.3	40	4.2	2.5		1.25 +0.02	● 172841	● 173467			
1.6	0.35	40	4.8	2.5		1.45 +0.02	● 170585	● 170916			
1.7	0.35	40	5.1	2.5		1.55 +0.02		● 172843			
1.8	0.35	40	5.4	2.5		1.65 +0.02	● 172842	● 172844			
2	0.4	45	8	2.8	2.1	1.8 +0.02			● 158814	● 172849	0.019
2.5	0.45	50	10	2.8	2.1	2.3 +0.02			● 172845	● 173246	0.020
2.6	0.45	50	10	2.8	2.1	2.4 +0.02			● 172846		

≤M1.5 **4HX**

FPS FORMING

FPS380DL-3		DLC	63 73	64 91	71 92	72 94
FPS381DL-3		DLC	63 73	64 91	71 92	72 94
FPS380VS-3		VS	11	12	13	14
FPS381VS-3		VS	11	12	13	14 15

FPS380DL-3 FPS381DL-3 FPS380VS-3 FPS381VS-3

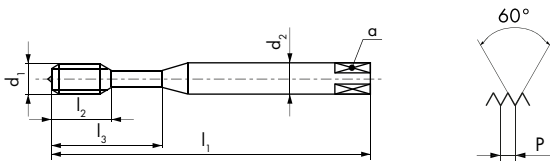

2.5 x P	2.5 x P	2.5 x P	2.5 x P
6HX	6HX	6HX	6HX

Ø d ₁ M	P mm	l ₁ mm	l ₂ mm	l ₃ mm	d ₂ mm	a mm	6HX Tol.
3	0.5	56	12	18	3.5	2.7	2.8 +0.03
3.5	0.6	56	13	20	4	3	3.25 +0.03
4	0.7	63	14	21	4.5	3.4	3.7 +0.03
5	0.8	70	15	25	6	4.9	4.65 +0.03
6	1	80	17	30	6	4.9	5.55 +0.05
8	1.25	90	20	35	8	6.2	7.4 +0.05
10	1.5	100	22	39	10	8	9.3 +0.05

ID	ID	ID	ID
● 170553	● 182038	● 166614	● 166616
● 175347	● 182623	● 166620	● 166622
● 170554	● 182039	● 166627	● 166629
● 182619	● 178343	● 166635	● 166637
● 182620	● 171112	● 166644	● 166646
● 182621	● 179144	● 166654	● 166656
● 182622	● 171113	● 166664	● 166666

6GX 6GX

Ø d ₁ M	P mm	l ₁ mm	l ₂ mm	l ₃ mm	d ₂ mm	a mm	6HX Tol.
3	0.5	56	12	18	3.5	2.7	2.8 +0.03
3.5	0.6	56	13	20	4	3	3.25 +0.03
4	0.7	63	14	21	4.5	3.4	3.7 +0.03
5	0.8	70	15	25	6	4.9	4.65 +0.03
6	1	80	17	30	6	4.9	5.55 +0.05
8	1.25	90	20	35	8	6.2	7.4 +0.05
10	1.5	100	22	39	10	8	9.3 +0.05

ID	6H + mm	ID	6H + mm
● 166697	0.020	● 166617	0.020
● 166687	0.021	● 166623	0.021
● 166688	0.022	● 166630	0.022
● 166689	0.024	● 166638	0.024
● 166686	0.026	● 166647	0.026
● 166740	0.028	● 166657	0.028
● 166739	0.032	● 166667	0.032

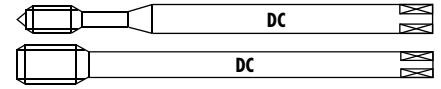

FPS FORMING

FPS481VS-3



11 12 13 14
15

FPS581VS-3



11 12 13 14
15

FPS681VS-3



11 12 13 14
15

FPS481VS-3

FPS581VS-3

FPS681VS-3

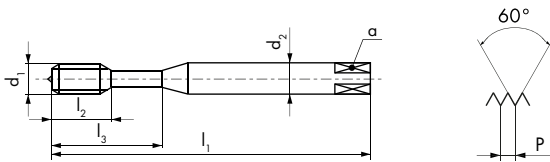

6HX

6HX

6HX

$\emptyset d_1$ M	P mm	l_1 mm	l_2 mm	d_2 mm	a mm	6HX Tol.
12	1.75	110	24	9	7	11.2 +0.05
14	2	110	28	11	9	13.1 +0.05
16	2	110	30	12	9	15.1 +0.05
20	2.5	140	36	16	12	18.85 +0.05

ID

- 166673
- 166678
- 166683
- 168713

$\emptyset d_1$ M	P mm	l_1 mm	l_2 mm	l_3 mm	d_2 mm	a mm	6HX Tol.
3	0.5	100	12	18	3.5	2.7	2.8 +0.03
4	0.7	125	14	21	4.5	3.4	3.7 +0.03
5	0.8	140	15	25	6	4.9	4.65 +0.03
6	1	160	17	30	6	4.9	5.55 +0.05
8	1.25	180	20	35	8	6.2	7.4 +0.05
10	1.5	200	22	39	10	8	9.3 +0.05
12	1.75	224	24		9	7	11.2 +0.05

ID

ID

- 172824
- 172826
- 172828
- 172830
- 172832
- 172834
- 172836

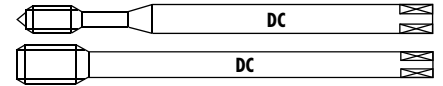
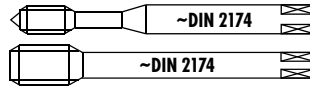

FPS FORMING

FPS384VS-3			VS	11/12/13/14 15
FPS484VS-3			VS	11/12/13/14 15
FPS584VS-3			EL VS	11/12/13/14 15
FPS684VS-3			EL VS	11/12/13/14 15

FPS384VS-3 FPS484VS-3 FPS584VS-3 FPS684VS-3

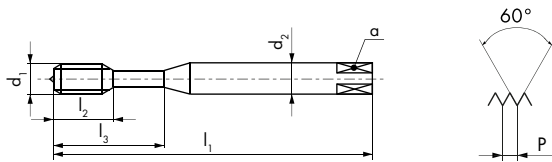

ϕd_1 M	P mm	l_1 mm	l_2 mm	l_3 mm	d_2 mm	a mm	6HX Tol.
3	0.5	56	12	18	3.5	2.7	2.8 +0.03
4	0.7	63	14	21	4.5	3.4	3.7 +0.03
5	0.8	70	15	25	6	4.9	4.65 +0.03
6	1	80	17	30	6	4.9	5.55 +0.05
8	1.25	90	20	35	8	6.2	7.4 +0.05
10	1.5	100	22	39	10	8	9.3 +0.05
12	1.75	110	24		9	7	11.2 +0.05
14	2	110	28		11	9	13.1 +0.05
16	2	110	30		12	9	15.1 +0.05

ID	ID
● 166737	
● 166738	
● 166640	
● 166650	
● 166660	
● 166670	
	● 166675
	● 166680
	● 166685

ϕd_1 M	P mm	l_1 mm	l_2 mm	l_3 mm	d_2 mm	a mm	6HX Tol.
3	0.5	100	12	18	3.5	2.7	2.8 +0.03
4	0.7	125	14	21	4.5	3.4	3.7 +0.03
5	0.8	140	15	25	6	4.9	4.65 +0.03
6	1	160	17	30	6	4.9	5.55 +0.05
8	1.25	180	20	35	8	6.2	7.4 +0.05
10	1.5	200	22	39	10	8	9.3 +0.05
12	1.75	224	24		9	7	11.2 +0.05

ID	ID
	● 172763
	● 172766
	● 172769
	● 172772
	● 172775
	● 172778
	● 172781

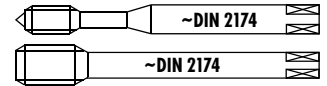

FAS FORMING

FAS380VS-3



VS

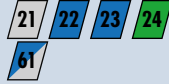

FAS381VS-3



VS



FAS481VS-3



VS



FAS380VS-3

FAS381VS-3

FAS481VS-3

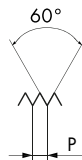
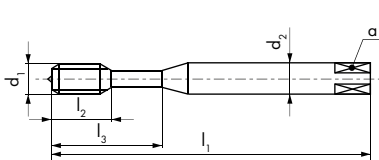

6HX

6HX

6HX

Ø d ₁ M	P mm	l ₁ mm	l ₂ mm	l ₃ mm	d ₂ mm	a mm	6HX Tol.
3	0.5	56	12	18	3.5	2.7	2.8 +0.03
3.5	0.6	56	13	20	4	3	3.25 +0.03
4	0.7	63	14	21	4.5	3.4	3.7 +0.03
5	0.8	70	15	25	6	4.9	4.65 +0.03
6	1	80	17	30	6	4.9	5.55 +0.05
8	1.25	90	20	35	8	6.2	7.4 +0.05
10	1.5	100	22	39	10	8	9.3 +0.05
12	1.75	110	24		9	7	11.2 +0.05
14	2	110	28		11	9	13.1 +0.05
16	2	110	30		12	9	15.1 +0.05
20	2.5	140	36		16	12	18.85 +0.05

ID

ID

ID

● 170603	● 166612	
● 170605	● 166618	
● 170607	● 166624	
● 170609	● 166632	
● 170611	● 166641	
● 170616	● 166651	
● 170618	● 166661	
		● 166671
		● 166676
		● 166681
		● 168711

6GX

6GX

Ø d ₁ M	P mm	l ₁ mm	l ₂ mm	l ₃ mm	d ₂ mm	a mm	6HX Tol.
3	0.5	56	12	18	3.5	2.7	2.8 +0.03
3.5	0.6	56	13	20	4	3	3.25 +0.03
4	0.7	63	14	21	4.5	3.4	3.7 +0.03
5	0.8	70	15	25	6	4.9	4.65 +0.03
6	1	80	17	30	6	4.9	5.55 +0.05
8	1.25	90	20	35	8	6.2	7.4 +0.05
10	1.5	100	22	39	10	8	9.3 +0.05
12	1.75	110	24		9	7	11.2 +0.05
14	2	110	28		11	9	13.1 +0.05
16	2	110	30		12	9	15.1 +0.05

ID

6H
+ mm

ID

6H
+ mm

● 166703	0.020		
● 166704	0.021		
● 166705	0.022		
● 166706	0.024		
● 166707	0.026		
● 166708	0.028		
● 166709	0.032		
		● 166710	0.034
		★ 166711	0.038
		● 166712	0.038

FAS FORMING

FAS384VS-3



FAS484VS-3



FAS384VS-3

FAS484VS-3

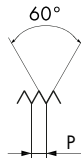
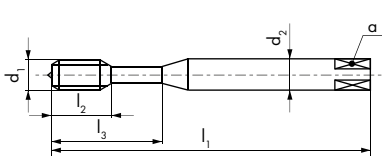

Ø d ₁ M	P mm	l ₁ mm	l ₂ mm	l ₃ mm	d ₂ mm	a mm	6HX Tol.	
3	0.5	56	12	18	3.5	2.7	2.8	+0.03
4	0.7	63	14	21	4.5	3.4	3.7	+0.03
5	0.8	70	15	25	6	4.9	4.65	+0.03
6	1	80	17	30	6	4.9	5.55	+0.05
8	1.25	90	20	35	8	6.2	7.4	+0.05
10	1.5	100	22	39	10	8	9.3	+0.05
12	1.75	110	24		9	7	11.2	+0.05
14	2	110	28		11	9	13.1	+0.05
16	2	110	30		12	9	15.1	+0.05

ID

ID

● 166741

● 166742

● 166690

● 166691

● 166692

● 166693

● 166694

● 166695

● 166696

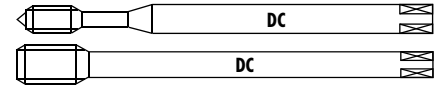

FAS FORMING

FAS581VS-3



FAS681VS-3



FAS584VS-3



FAS684VS-3



FAS581VS-3

FAS681VS-3

FAS584VS-3

FAS684VS-3



6HX

6HX

6HX

6HX

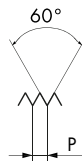
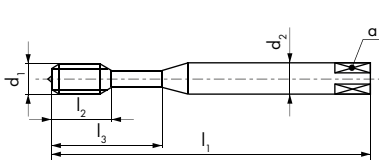

$\emptyset d_1$ M	P mm	l_1 mm	l_2 mm	l_3 mm	d_2 mm	a mm	6HX Tol.
3	0.5	100	12	18	3.5	2.7	2.8 +0.03
4	0.7	125	14	21	4.5	3.4	3.7 +0.03
5	0.8	140	15	25	6	4.9	4.65 +0.03
6	1	160	17	30	6	4.9	5.55 +0.05
8	1.25	180	20	35	8	6.2	7.4 +0.05
10	1.5	200	22	39	10	8	9.3 +0.05
12	1.75	224	24		9	7	11.2 +0.05

ID

ID

ID

ID

● 172784

● 172787

● 172790

● 172793

● 172796

● 172799

● 172805

● 172808

● 172811

● 172814

● 172817

● 172820

● 172802

● 172822

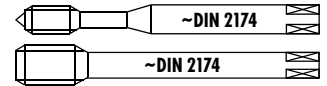

FPS FAS		FORMING						FPS381VS-3	FPS481VS-3	FAS381VS-3	FAS481VS-3
FPS381VS-3		VS	11	12	13	14	15				
FPS481VS-3		VS	11	12	13	14	15				
FAS381VS-3		VS	21	22	23	24	41	51	61	< 2.5 x D	< 2.5 x D
FAS481VS-3		VS	21	22	23	24	41	51	61	< 2.5 x D	< 2.5 x D
$\emptyset d_1$	P	l_1	l_2	l_3	d_2	a	6HX Tol.	ID	ID	ID	ID
MF	mm	mm	mm	mm	mm	mm					
4	0.5	63	14	21	4.5	3.4	3.8 +0.03	● 166631		● 166625	
5	0.5	70	15	25	6	4.9	4.8 +0.03	● 166639		● 166633	
6	0.5	80	17	30	6	4.9	5.8 +0.03	● 166699		● 166698	
6	0.75	80	17	30	6	4.9	5.65 +0.03	● 166649		● 166642	
8	0.75	90	20	35	8	6.2	7.65 +0.03	● 166702		● 166700	
8	1	90	20	35	8	6.2	7.55 +0.05	● 166659		● 166652	
10	1	100	22	39	10	8	9.55 +0.05	● 166669		● 166662	
12	1	100	19		9	7	11.55 +0.05		● 166674		● 166672
14	1.5	100	24		11	9	13.3 +0.05		● 166679		● 166677
16	1.5	100	26		12	9	15.3 +0.05		● 166684		● 166682

FS FPS FAS FORMING										FS380VS-3	FPS381VS-3	FAS381VS-3
FS380VS-3 VS												
FPS381VS-3 VS												
FAS381VS-3 VS												
$\emptyset'' d_1$ UNC	P TPI	d_1 mm	l_1 mm	l_2 mm	l_3 mm	d_2 mm	a mm	$\frac{d_1}{P}$	2BX Tol.	ID	ID	ID
2	56	2.18	45	9		2.8	2.1	1.95	+0.02	● 157285		
4	40	2.84	56	12	18	3.5	2.7	2.55	+0.03		● 170063	● 170065
6	32	3.5	56	13	20	4	3	3.15	+0.03		● 166713	● 166725
8	32	4.16	63	14	21	4.5	3.4	3.8	+0.03		● 166714	● 166726
10	24	4.82	70	15	25	6	4.9	4.35	+0.05		● 166715	● 166727
1/4	20	6.35	80	17	30	7	5.5	5.75	+0.05		● 166716	● 166728

FS FPS FORMING FAS										FS380VS-5	FPS381VS-3	FAS381VS-3
FS380VS-5 VS 11 12 13 14 21												
FPS381VS-3 VS 11 12 13 14 15												
FAS381VS-3 VS 21 22 23 24 41 51 61												
$\emptyset'' d_1$ UNF	P TPI	d_1 mm	l_1 mm	l_2 mm	l_3 mm	d_2 mm	a mm		Tol.	ID	ID	ID
0	80	1.52	40	4.6		2.5	1.37	+0.02	● 161498			
10	32	4.82	70	15	25	6	4.9	+0.03		● 166718	● 166730	
1/4	28	6.35	80	17	30	7	5.5	+0.05		● 166719	● 166731	
5/16	24	7.93	90	20	35	8	6.2	+0.05		● 166720	● 166732	

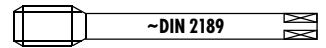

FPS FAS				FPS481VS-3		FAS481VS-3			
FPS481VS-3 VS									
FAS481VS-3 VS				< 2.5 x D		< 2.5 x D			
				2.5 x P		2.5 x P			
$\emptyset'' d_1$ G	P TPI	d_1 mm	l_1 mm	l_2 mm	d_2 mm	a mm	Tol.	ID	ID
1/8	28	9.72	90	22	7	5.5	9.25 +0.05	● 166721	● 166733
1/4	19	13.15	100	20	11	9	12.5 +0.05	● 166722	● 166734
3/8	19	16.66	100	20	12	9	16 +0.05	● 166723	● 166735
1/2	14	20.95	125	22	16	12	20 +0.05	● 166724	● 166736

FILIÈRES AVEC ENTRÉE À HÉLICE

L'entrée à hélice favorise l'évacuation des copeaux et évite un bourrage de copeaux. Cela permet d'éviter l'accumulation de copeaux dans les trous de dégagement. Le résultat est un meilleur état de surface du filetage, ainsi qu'un rendement supérieur de l'outil.

C'est pourquoi les filières pour l'utilisation de machines doivent être commandées avec entrée à hélice.



FILIERE CON IMBOCCO CORRETTO

L'ingresso elicoidale fa sì che i trucioli scorrano liberamente in avanti e riduce la coppia di taglio. In questo modo si evita l'accumulo di trucioli nei fori di scarico. Il risultato è una migliore qualità superficiale dei filetti tagliati e una maggiore durata dell'utensile.

Per questo motivo le filiere per l'utilizzo a macchina devono essere ordinate con l'imbocco corretto.

FILIÈRES À HAUTE PERFORMANCE

FILIERE AD ALTE PRESTAZIONI

N5110/N5120



avec entrée à hélice dès Ø 3 mm
con imbocco corretto a partire da Ø 3 mm

Filières rondes en HSS, selon normes DIN EN

pour travail à main et à machine

- Pour usiner des aciers jusqu'à 800 N/mm²
- Différentes versions pour usiner un large champ de matériaux

Filiere tonde in HSS, secondo le norme DIN EN

per il lavoro a mano e a macchina

- Per la lavorazione di acciai fino a 800 N/mm²
- Diverse versioni per la lavorazione di una vasta gamma di materiali

Z5120



avec entrée à hélice dès Ø 2 mm
con imbocco corretto a partire da Ø 2 mm

Filières rondes en HSSE, selon normes DIN EN

- Finesse des copeaux due à un plus grand nombre de trous de dégagement et donc plus d'arêtes de coupe, et à l'extension du chanfrein à 2 x P
- Pour l'usinage des aciers inoxydables, des aciers de traitement thermique, des aciers de cémentation, etc. jusqu'à 1'200 N/mm² et des alliages ALU à copeaux courts

Filiere tonde in HSSE, secondo le norme DIN EN

- Trucioli fini a causa di più fori liberi e quindi più spigoli di taglio, e l'estensione dello smusso a 2 x P
- Per la lavorazione di acciai inossidabili, acciai da bonifica, acciai da cementazione ecc. fino a 1'200 N/mm² e leghe di alluminio a truciolo corto

Z5120 LL Long Life



avec entrée à hélice dès Ø 2 mm
con imbocco corretto a partire da Ø 2 mm

Filières rondes en HSSE (ASP), selon normes DIN EN

- Copeaux très fins en raison du nombre maximum de trous de dégagement et donc encore plus d'arêtes de coupe, et de l'extension du chanfrein de 2.25 x P
- Pour usiner des grandes séries
- Durée de vie exceptionnellement longue
- Pour l'usinage des aciers inoxydables, des aciers de traitement thermique, des aciers de cémentation, etc. jusqu'à 1'200 N/mm² et des alliages ALU à copeaux courts

Filiere tonde in HSSE (ASP), secondo le norme DIN EN

- Trucioli molto fini a causa del numero massimo di fori liberi e quindi di un numero ancora maggiore di taglienti, e l'estensione dello smusso di 2.25 x P
- Per la lavorazione di grandi serie
- Eccezionalmente allunga la vita del dado
- Per la lavorazione di acciai inossidabili, acciai da bonifica, acciai da cementazione ecc. fino a 1'200 N/mm² e leghe di alluminio a truciolo corto

MS5120



avec entrée à hélice
con imbocco corretto

Filières rondes en HSS, selon normes DIN EN

- Avec des trous de dégagement élargis pour éviter l'encombrement des copeaux
- Pour l'usinage de laiton à copeaux courts

Filiere tonde in HSS, secondo le norme DIN EN

- Con fori di scarico allargati per evitare l'intasamento dei trucioli
- Per la lavorazione dell'ottone a truciolo corto

N5220 Z5220

MS5220



avec entrée à hélice
con imbocco corretto

Filières pour automates, en HSS, avec 2 trous de fixation

- Champs d'application selon N5120, MS5120 et Z5120
- Avantage : grâce à la faible inertie de masse du porte-outil, des vitesses plus élevées / une durée de vie plus longue sont possibles

Filiere per torni automatici, in HSS, con 2 fori di fissaggio

- Campo di applicazione secondo N5120, MS5120 e Z5120
- Vantaggio: grazie alla minore inerzia della massa del portastampo, sono possibili velocità più elevate e una maggiore durata dell'utensile

N5310



Écrous égalisateurs en HSS, dimensions générales selon DIN 382

- Pour retailler et réparer des filetages endommagés ou pour couper dans des endroits difficiles d'accès

Filiere esagonali, in HSS, dimensioni generali secondo DIN 382

- Per il taglio e la riparazione di filettature danneggiate o per il taglio in punti di difficile accesso

N5420



avec entrée à hélice dès Ø 3 mm
con imbocco corretto a partire da Ø 3 mm

Filières forme cloche en HSS

- Avantage : écoulement libre des copeaux et meilleure alimentation en liquide de refroidissement grâce aux trous de dégagement ouverts, même lorsque les filets sont coupés près des épaulements

Filiere a campana, in HSS

- Vantaggio: flusso libero di trucioli e migliore alimentazione del lubro-refrigerante attraverso gli spazi aperti per i trucioli, anche quando si taglia vicino al collare

TABELLE D'UTILISATION POUR FILIÈRES COUPANTES

TABELLE D'IMPIEGO PER FILIERE

Désignation des matières	Référence DIN	Vitesse de coupe Vc m/min (guide line)	Lubrifiant	Angle taillant	Type de filière
Aciers de construction	St37-2, St50-2	8 - 12	Huile de coupe	17 - 22°	N5...
Aciers de décolletage	9SMn28, 9SMnPb28	10 - 14	Huile de coupe	17 - 22°	N5...
Aciers de cémentation	C15, Ck15, 16MnCr5	6 - 10	Huile de coupe / Huile de coupe spéciale	17 - 22°	Z5... / Z5... LL
Aciers au carbone	C35Pb, C45	5 - 8	Huile de coupe / Huile de coupe spéciale	13 - 18°	Z5... / Z5... LL
Aciers inoxydables, soufrés	X12CrMoS17, X12CrNiS188	4 - 6	Huile de coupe spéciale	13 - 18°	Z5... / Z5... LL
Laiton à copeaux courts MS 58	CuZn39Pb2, CuZn40Pb2	20 - 30	Huile de coupe	6 - 11°	MS5...
Laiton à copeaux longs MS 60	CuZn20, CuZn37	12 - 18	Huile de coupe	10 - 15°	N5...
Al allié à copeaux courts	GD-ALSi8Cu3, GD-ALSi12	8 - 12	Huile de coupe spéciale, Pétrolium	18 - 23°	Z5...
Titane pur	Ti2	5 - 8	Huile de coupe spéciale	19 - 24°	Z5... / Z5... LL

Filières avec un angle de coupe spécialement adapté pour la fonte grise, le laiton sans plomb, le bronze, le bronze à canon, le cuivre et les alliages d'aluminium à copeaux longs sont livrables en version spéciale.

Sur demande, nous pouvons également fournir des filières revêtues. Prix et délai de livraison sur demande.

Designazione dei materiali	Referenze	Velocità di taglio Vc m/min (guide line)	Lubrificante	Angolo di spoglia frontale	Typo di filiere
Acciai da costruzione	St37-2, St50-2	8 - 12	Olio da taglio	17 - 22°	N5...
Acciai da tornitura	9SMn28, 9SMnPb28	10 - 14	Olio da taglio	17 - 22°	N5...
Acciai da cementazione	C15, Ck15, 16MnCr5	6 - 10	Olio da taglio / Olio da taglio speciale	17 - 22°	Z5... / Z5... LL
Acciai al carbonio	C35Pb, C45	5 - 8	Olio da taglio / Olio da taglio speciale	13 - 18°	Z5... / Z5... LL
Acciai inox allo zolfo	X12CrMoS17, X12CrNiS188	4 - 6	Olio da taglio speciale	13 - 18°	Z5... / Z5... LL
Ottone, trucioli corti, Ms 58	CuZn39Pb2, CuZn40Pb2	20 - 30	Olio da taglio	6 - 11°	MS5...
Ottone, trucioli lunghi, MS 60	CuZn20, CuZn37	12 - 18	Olio da taglio	10 - 15°	N5...
Leghe di alluminio, trucioli corti	GD-ALSi8Cu3, GD-ALSi12	8 - 12	Olio da taglio speciale, Petrolio	18 - 23°	Z5...
Titanio puro	Ti2	5 - 8	Olio da taglio speciale	19 - 24°	Z5... / Z5... LL

Filiere con angolo di spoglia appositamente adattato per ghisa grigia, ottone senza piombo, bronzo, bronzo canna di fucile, rame, leghe di alluminio a trucioli lunghi sono disponibili in versione speciale.

Su richiesta, possiamo fornire anche filiere in versione rivestita. Prezzo e tempi di consegna su richiesta.

TOLÉRANCES POUR FILETAGES M ET MF

TOLLERANZE PER LE FILLETATURE M E MF

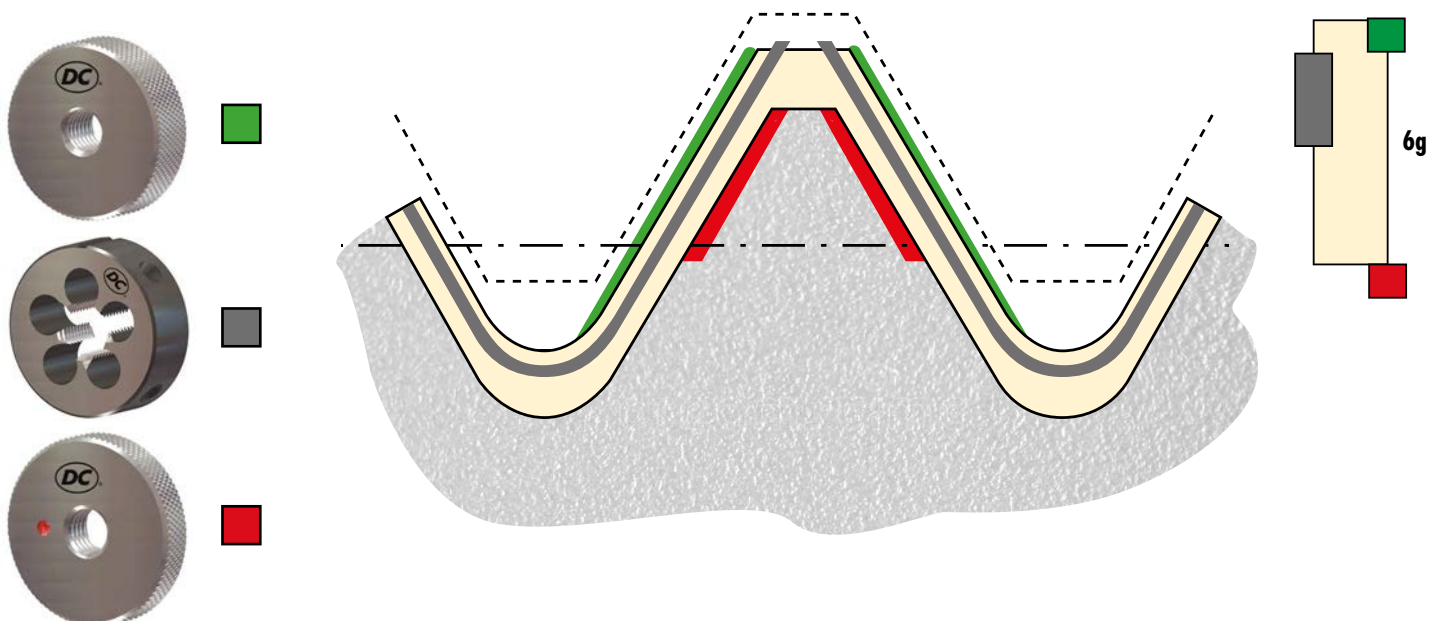

CODIFICATION — CODIFICAZIONE



Exemple

Z	51	20	LL	SP
---	----	----	----	----

Matières normales	N				
Laiton à copeaux courts	MS				
Matières tenaces	Z				
Filières rondes*		51			
Filières pour automates, avec 2 trous de fixation		52			
Écrous égalisateurs		53			
Filières forme cloche		54			
Solide, forme B			10		
Solide, forme B, avec entrée à hélice			20		
Long Life - Filière à haute performance				LL	
Exécution spéciale					SP

* Pour la production, utilisez des filières avec entrée à hélice.



Esempio

Z	51	20	LL	SP
---	----	----	----	----

Materiali normali	N				
Ottone a truciolo corto	MS				
Materiali tenaci	Z				
Filiere tonde*		51			
Filiere per torni automatici, con 2 fori di fissaggio		52			
Filiere esagonali		53			
Filiere a campana		54			
Solido, forma B			10		
Solido, forma B, con imbocco corretto			20		
Long Life - Filiera ad alte prestazioni				LL	
Esecuzione speciale					SP

* Per la produzione, utilizzare filiere con imbocco corretto.

Filières rondes en HSS, selon normes DIN EN

DIN EN 22568 : pour filetages M, MF, UNC, UNF, UNEF, UN, UNS et W (BSW)

≈ DIN EN 22568 : pour filetages coniques américains NPT selon ASME B1.20.1 et NPTF selon ANSI B1.20.3

≈ DIN EN 22568 : pour filetages TR selon DIN 103

DIN EN 24231 : pour filetages G (BSP) selon DIN EN ISO 228

≈ DIN EN 24230 : pour filetages coniques Whitworth R selon DIN EN 10226, ISO 7-1

≈ DIN 40434 et DIN 22568 : pour filetages PG (filetage de conduit en acier) selon DIN 40430

Filiera tonde in HSS, secondo le norme DIN EN

DIN EN 22568: per filettature M, MF, UNC, UNF, UNEF, UN, UNS e W (BSW)

≈ DIN EN 22568: per filettature coniche americane NPT secondo ASME B1.20.1 e NPTF secondo ANSI B1.20.3

≈ DIN EN 22568: per filettature TR secondo DIN 103

DIN EN 24231: per filettature G (BSP) secondo DIN EN ISO 228

≈ DIN EN 24230: per filettature coniche Whitworth R secondo DIN EN 10226, ISO 7-1

≈ DIN 40434 e DIN EN 22568: per filettature PG (filettatura di raccordi in acciaio) secondo DIN 40430

N: HSS, longueur d'entrée 1.75 x P

MS: HSS, rodée, longueur d'entrée 1.25 x P

Z: HSSE, nitrurée dès Ø 3 mm (P = 0.5 mm),
longueur d'entrée 2 x P, entrée à hélice dès Ø 2 mm

Z-LL: ASP, nitrurée dès Ø 3 mm (P = 0.5 mm),
longueur d'entrée 2.25 x P, entrée à hélice dès Ø 2 mm

N: HSS, lunghezza dell'imbocco 1.75 x P

MS: HSS, terra, lunghezza dell'imbocco 1.25 x P











Z: HSSE, nitrurati a partire da Ø 3 mm (P = 0.5 mm), lunghezza
dell'imbocco 2 x P, con imbocco corretto a partire da Ø 2 mm

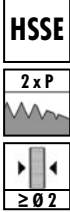

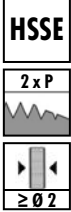
Z-LL: ASP, nitrurati a partire da Ø 3 mm (P = 0.5 mm), lunghezza
dell'imbocco 2.25 x P, con imbocco corretto a partire da Ø 2 mm







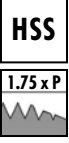
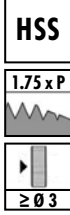











Répertoire — Filières rondes, filières pour automates, écrous égalisateurs et filières cloches

Rubrica — Filiera tonda, filiera per torni automatici, filiera esagonali e filiera a campana

		N		MS	Z		N	Z
Caractéristiques Caratteristiche								
			$\geq \emptyset 3$	$\geq \emptyset 3$	$\geq \emptyset 2$	$\geq \emptyset 2$	$\geq \emptyset 3$	$\geq \emptyset 2$
					NI	NI		NI
								
Type Tipo		N5110	N5120	MS5120	Z5120	Z5120LL	N5220	Z5220
M 6g	ISO DIN 13	272	272		273	273	286	286
M 6e	ISO DIN 13		272				286	
M 6g LH	ISO DIN 13		272					
MF 6g	ISO DIN 13	274	274 - 276		274 - 275		287	
MF 6e	ISO DIN 13		274					
MF 6g LH	ISO DIN 13		274 - 276					
UNC	ASME B1.1	277	277					
UNF	ASME B1.1	278	278					
UNEF	ASME B1.1		279					
UN	ASME B1.1		279					
UNS	ASME B1.1		279					
G (BSP)	DIN EN ISO 228		280	281	281			
G (BSP) LH	DIN EN ISO 228		280					
G (BSP) -0.1mm	DIN EN ISO 228			281				
R (BSPT)	DIN EN 10226		282					
NPT	ASME B1.20.1		283					
NPTF	ANSI B1.20.3		283					
PG	DIN 40430		284					
TR	DIN 103		284					
W (BSW)	BS 84		285					
W (BSW) LH	BS 84		285					

N	
	
	
N5310	N5420
288	289
288	
289	
289	

Pictogrammes - Simboli

	HSS HSS
	HSSE HSSE
	1.25 filets d'entrée 1.25 filetti d'imbocco
	1.75 filets d'entrée 1.75 filetti d'imbocco
	2 filets d'entrée 2 filetti d'imbocco
	Entrée à hélice dès Ø 3 mm Imbocco corretto a partire da Ø 3 mm
	Entrée à hélice des 2 côtés dès Ø 3 mm Imbocco corretto dei 2 lati a partire da Ø 3 mm
	Nombre de lèvres Numero delle scanalature
	Diamètre de tournage Diametro di tornitura
	Nitruration ($d_1 \geq 3 \text{ mm}$, $P \geq 0.5 \text{ mm}$) Nitrurazione ($d_1 \geq 3 \text{ mm}$, $P \geq 0.5 \text{ mm}$)
	Filière avec 2 trous de fixation Filiere con 2 fori di fissaggio
	Tolérance 6g Tolleranza 6g
	Tolérance 6e Tolleranza 6e
	Tolérance "Medium Class" Tolleranza "Medium Class"
	Tolérance A Tolleranza A
	Filetage conique 1:16 (NPT - NPTF - R) Filettatura conica 1:16 (NPT - NPTF - R)
	Filetage à gauche Filettatura sinistra















N5110								N5120		N5120 LH		N5120							
$\emptyset d_1$ M	P mm	d_2 mm	l_1 mm	6g	LH / 6e	6g	6e	ID	ID	ID	ID	6g	6e						
1	0.25	16	5	3		0.97		● 103851											
1.1	0.25	16	5	3		1.07		● 124659											
1.2	0.25	16	5	3		1.17		● 103852											
1.4	0.3	16	5	3		1.36		● 103853											
1.6	0.35	16	5	3		1.54		● 103855											
1.7	0.35	16	5	3		1.64		● 103856											
1.8	0.35	16	5	3		1.74		● 103857											
2	0.4	16	5	3		1.93		● 103864											
2.2	0.45	16	5	3		2.13		● 103867											
2.3	0.4	16	5	3		2.23		● 103869											
2.5	0.45	16	5	3		2.43		● 103872											
2.6	0.45	16	5	3		2.53		● 103876											
3	0.5	20	5	3	4	2.92	2.9	● 103879	● 104067	● 104068	● 104066	0.030							
3.5	0.6	20	5	3	4	3.41		● 103880	● 104071	● 104072									
4	0.7	20	5	3	4	3.91	3.87	● 103881	● 104114	● 104115	● 104113	0.035							
4.5	0.75	20	7	4		4.4		* 103882	● 104117										
5	0.8	20	7	4	4	4.9	4.87	● 103883	● 104146	● 104147	● 104145	0.035							
5.5	0.9	20	7	4		5.4		* 103884											
6	1	20	7	4	4	5.88	5.85	● 103885	● 104165	● 104166	● 104164	0.035							
7	1	25	9	4	4	6.88		● 103886	● 104174	● 104175									
8	1.25	25	9	4	4	7.87	7.83	● 103887	● 104186	● 104187	● 104185	0.035							
9	1.25	25	9	4		8.87		* 103888	● 104191										
10	1.5	30	11	4	4	9.85	9.82	● 103858	● 103953	● 103954	● 103952	0.035							
12	1.75	38	14	4	4	11.83	11.8	● 103859	● 103973	● 103974	● 103972	0.035							
14	2	38	14	4	4	13.82		● 103860	● 103989	● 103990									
16	2	45	18	4	4	15.82		● 103861	● 104003	● 104004									
18	2.5	45	18	5		17.79			● 104015										
20	2.5	45	18	5	5	19.79		● 103878	● 104028	● 104029									
22	2.5	55	22	5		21.79			● 104035										
24	3	55	22	5	5	23.76			● 104043	● 104044									
27	3	65	25	5		26.76			● 104058										
30	3.5	65	25	6	6	29.73			● 104079	● 104080									
33	3.5	65	25	6		32.73			● 104089										
36	4	65	25	7		35.7			● 104100										



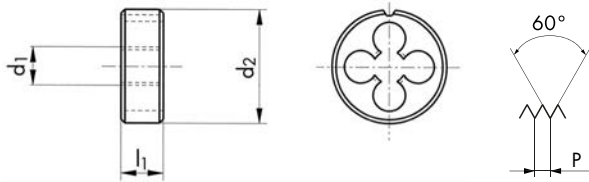





≤M1.4 **6h**



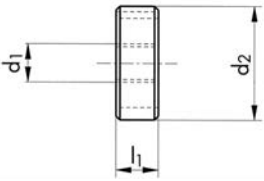
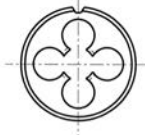
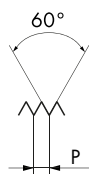







Z5120		Z5120 LL					Z5120	Z5120 LL		
 ≥ Ø2 NI		 13 14 21								
 ≥ Ø2 NI		 13 14 15 21					 60° P			
							 2 x P		 2.25 x P	
							 6g		 6g	
Ø d ₁ M	P mm	d ₂ mm	l ₁ mm	 Z5120	 Z5120LL	 6g ^c	ID	ID		
2	0.4	16	3.5	4	4	1.93	● 125269	● 105115		
2.5	0.45	16	5	4	4	2.43	● 104779	● 105116		
2.6	0.45	16	5	4		2.53	★ 104780			
3	0.5	20	5	4	5	2.92	● 104788	● 105117		
3.5	0.6	20	5	4		3.41	● 104789			
4	0.7	20	5	4	5	3.91	● 104790	● 105118		
5	0.8	20	7	4	5	4.9	● 104792	● 105119		
6	1	20	7	4	5	5.88	● 104795	● 105120		
7	1	25	9	4		6.88	★ 111424			
8	1.25	25	9	5	6	7.87	● 104798	● 105121		
10	1.5	30	11	5	6	9.85	● 104767	● 105122		
12	1.75	38	14	5	6	11.83	● 104770	● 105123		
14	2	38	14	5		13.82	● 104773			
16	2	45	18	5		15.82	● 104776			
18	2.5	45	18	5		17.79	● 104778			
20	2.5	45	18	5		19.79	● 104783			
24	3	55	22	6		23.76	● 104787			

N5120								N5120	N5120 LH	N5120	Z5120	
Z5120												
								1.75 x P	1.75 x P	1.75 x P	2 x P	
								6g	6g	6e	6g	
Ø d ₁ MF	P mm	d ₂ mm	l ₁ mm	N	Z	6g	6e	ID	ID	ID	6g - mm	ID
*2	0.25	16	5	4		1.93		● 103863				
*2.5	0.35	16	5	4		2.44		● 103871				
3	0.35	20	5	4		2.94		● 104064				
3.5	0.35	20	5	4		3.44		● 104069				
4	0.35	20	5	4		3.94		● 104108				
4	0.5	20	5	4		3.93		● 104110				
4.5	0.5	20	5	4		4.43		● 104116				
5	0.5	20	5	4	4	4.93	4.9	● 104141	● 104142	● 104140	0.030	● 104791
5	0.75	20	7	4		4.9		● 104143				
5.5	0.5	20	5	4		5.43		● 104148				
6	0.5	20	5	4	4	5.93		● 104159	● 104160			● 104793
6	0.75	20	7	4	4	5.9		● 104162	● 104163			● 104794
7	0.5	25	9	4		6.93		● 104169				
7	0.75	25	9	4		6.9		● 104171				
8	0.5	25	9	5		7.93		● 104177				
8	0.75	25	9	4	4	7.9		● 104180				● 104796
8	1	25	9	4	4	7.88	7.85	● 104183	● 104184	● 104182	0.035	● 104797
9	0.5	25	9	5		8.93		● 104188				
9	0.75	25	9	5		8.9		● 104189				
9	1	25	9	5		8.88		● 104190				
10	0.5	30	11	5		9.93		● 103942				
10	0.75	30	11	5	5	9.9		● 103945				● 104765
10	1	30	11	5	5	9.88	9.85	● 103948	● 103949	● 103947	0.035	● 104766
10	1.25	30	11	4		9.86		● 103950	● 103951			
11	0.75	30	11	5		10.9		● 103956				
11	1	30	11	5		10.88		● 103957				
11	1.25	30	11	5		10.86		● 103958				
12	0.5	38	10	5		11.93		● 103960				
12	0.75	38	10	5		11.9		● 103962				
12	1	38	10	5	5	11.88	11.85	● 103965	● 103966	● 103964	0.035	● 104768
12	1.25	38	10	4		11.86		● 103967	● 103968			
12	1.5	38	10	4	5	11.85		● 103970	● 103971			● 104769
13	1	38	10	5		12.88		● 103976				
* N5110								P 0.25 6h				

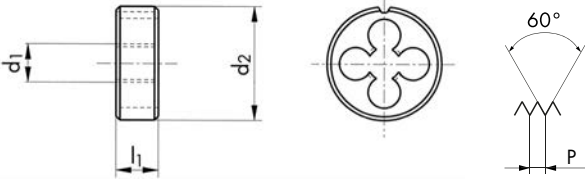
N5120							N5120	N5120 LH	Z5120
Ø d ₁ MF	P mm	d ₂ mm	l ₁ mm	N	Z	6g	ID	ID	ID
14	0.5	38	10	5		13.93	● 103977		
14	0.75	38	10	5		13.9	● 103979		
14	1	38	10	5	5	13.88	● 103981	● 103982	● 104771
14	1.25	38	10	5		13.86	● 103983		
14	1.5	38	10	5	5	13.85	● 103986	● 103987	● 104772
15	1	38	10	5		14.88	● 103991		
15	1.5	38	10	5		14.85	● 103992		
16	1	45	14	5	5	15.88	● 103996	● 103997	● 104774
16	1.25	45	14	5		15.86	● 103998		
16	1.5	45	14	5	5	15.85	● 104000	● 104001	● 104775
17	1	45	14	5		16.88	● 104005		
18	1	45	14	5		17.88	● 104008		
18	1.5	45	14	5		17.85	● 104011	● 104012	
18	2	45	14	5		17.82	● 104013		
19	1	45	14	6		18.88	● 104017		
20	1	45	14	6	6	19.88	● 104021	● 104022	● 104781
20	1.5	45	14	6	6	19.85	● 104024	● 104025	● 104782
20	2	45	14	6		19.82	● 104026		
21	1	45	14	7		20.88	● 111386		
22	1	55	16	6		21.88	● 104030		
22	1.5	55	16	5		21.85	● 104032		
22	2	55	16	5		21.82	● 104034		
23	1	55	16	6		22.88	● 121704		
24	1	55	16	6		23.88	● 104037		
24	1.5	55	16	6		23.85	● 104039		
24	2	55	16	6		23.82	● 104041	● 104042	
25	1	55	16	6		24.88	● 104045		
25	1.5	55	16	6		24.85	● 104046		
26	1	55	16	7		25.88	● 104049		
26	1.5	55	16	6		25.85	● 104050		
26	2	55	16	6		25.82	● 104052		
27	1	65	18	6		26.88	● 104053		
27	1.5	65	18	6		26.85	● 104054		
27	2	65	18	6		26.82	● 104056		

						N5120	N5120 LH		
<p>N5120   </p> <p>N5120 LH    </p>									
									
Ø d ₁ MF	P mm	d ₂ mm	l ₁ mm		 6g	ID	ID		
28	1	65	18	6	27.88	● 104060			
28	1.5	65	18	6	27.85	● 104061			
30	1	65	18	7	29.88	● 104073			
30	1.5	65	18	6	29.85	● 104074			
30	2	65	18	6	29.82	● 104076			
32	1.5	65	18	7	31.85	● 104082	* 104083		
33	1.5	65	18	7	32.85	● 104085			
33	2	65	18	7	32.82	● 104086			
34	1.5	65	18	7	33.85	● 104091			
35	1.5	65	18	8	34.85	● 104092			
36	1.5	65	18	8	35.85	● 104095			
36	2	65	18	8	35.82	● 104097			
36	3	65	25	7	35.76	● 104099			
38	1.5	75	20	7	37.85	● 104101			
39	1.5	75	20	7	38.85	● 104104			
40	1.5	75	20	8	39.85	● 104118			
40	2	75	20	7	39.82	● 104120			
42	1.5	75	20	8	41.85	● 104122			
42	3	75	20	8	41.76	● 104125			
45	1.5	90	22	7	44.85	● 104127			
45	2	90	22	7	44.82	● 104129			
48	1.5	90	22	8	47.85	● 104133	* 104134		
48	2	90	22	8	47.82	● 104135			
48	3	90	22	7	47.76	● 104137			
50	1.5	90	22	8	49.85	● 104150			
60	2	105	22	9	59.82	● 104168			













N5110							N5110	N5120		
										
  										
										
\emptyset " d ₁ UNC	P TPI	d ₁ mm	d ₂ mm	l ₁ mm		 →2A←	ID	ID		
1	64	1.85	16	5	3	1.79	● 103893			
2	56	2.18	16	5	4	2.12	● 103894			
3	48	2.51	16	5	4	2.44	● 103895			
4	40	2.84	16	5	4	2.76	● 103896			
5	40	3.17	20	5	4	3.09		● 104263		
6	32	3.5	20	7	4	3.41		● 104266		
8	32	4.16	20	7	4	4.07		● 104269		
10	24	4.82	20	7	4	4.71		● 104258		
12	24	5.48	20	7	4	5.37		● 104259		
1/4	20	6.35	20	7	4	6.22		● 104256		
5/16	18	7.93	25	9	4	7.8		● 104264		
3/8	16	9.52	30	11	4	9.37		● 104262		
7/16	14	11.11	30	11	4	10.95		● 104267		
1/2	13	12.7	38	14	4	12.52		● 111387		
9/16	12	14.28	38	14	4	14.1		● 104270		
5/8	11	15.87	45	18	4	15.68		● 104265		
3/4	10	19.05	45	18	5	18.84		● 104261		
7/8	9	22.22	55	22	5	22		● 104268		
1	8	25.4	55	22	5	25.16		● 104257		
1 1/4	7	31.75	65	25	6	31.49		● 104251		
1 1/2	6	38.1	75	30	6	37.81		● 104250		
2	4.5	50.8	90	36	7	50.45		★ 104260		

							N5110	N5120		
<p>N5110 </p> <p>N5120  </p>										
										
Ø" d ₁ UNF	P TPI	d ₁ mm	d ₂ mm	l ₁ mm			ID	ID		
0	80	1.52	16	5	3	1.47	● 103897			
1	72	1.85	16	5	3	1.79	● 103898			
2	64	2.18	16	5	4	2.12	● 103899			
3	56	2.51	16	5	4	2.44	● 103900			
4	48	2.84	16	5	4	2.77	● 103901			
5	44	3.17	20	5	4	3.1		● 104299		
6	40	3.5	20	5	4	3.42		● 104302		
8	36	4.16	20	7	4	4.08		● 104305		
10	32	4.82	20	7	4	4.73		● 104295		
12	28	5.48	20	7	4	5.38		● 104296		
1/4	28	6.35	20	7	4	6.24		● 104293		
5/16	24	7.93	25	9	4	7.82		● 104300		
3/8	24	9.52	30	11	4	9.41		● 104298		
7/16	20	11.11	30	11	5	10.98		● 104303		
1/2	20	12.7	38	10	5	12.56		● 104292		
9/16	18	14.28	38	10	5	14.14		● 104306		
5/8	18	15.87	45	14	5	15.73		● 104301		
3/4	16	19.05	45	14	6	18.89		● 104297		
7/8	14	22.22	55	16	5	22.05		● 104304		
1	12	25.4	55	16	6	25.21		● 104294		
1 1/4	12	31.75	65	18	7	31.56		● 104289		
1 1/2	12	38.1	75	20	7	37.91		● 111390		

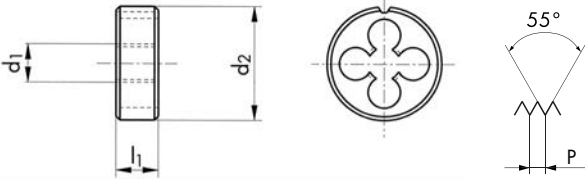
UNEF, UNS, UN ASME B1.1



N5120							N5120			
\varnothing " d_1 UNEF	P TPI	d_1 mm	d_2 mm	l_1 mm			ID			
12	32	5.48	20	7	4	5.39	● 104278			
1/4	32	6.35	20	7	4	6.25	● 104275			
5/16	32	7.93	25	9	4	7.84	● 104283			
3/8	32	9.52	30	11	4	9.42	● 104282			
7/16	28	11.11	30	11	5	11	● 104285			
1/2	28	12.7	38	10	5	12.59	● 104274			
9/16	24	14.28	38	10	5	14.17	● 104287			
5/8	24	15.87	45	14	5	15.75	● 104284			
3/4	20	19.05	45	14	6	18.91	● 104281			
\varnothing " d_1 UNS	P TPI	d_1 mm	d_2 mm	l_1 mm			ID			
1/4	40	6.35	20	5	4	6.26	● 104309			
1/4	36	6.35	20	5	4	6.26	● 104308			
7/16	24	11.11	30	11	5	10.99	● 104311			
1/2	24	12.7	38	10	5	12.58	● 104307			
1	14	25.4	55	16	6	25.23	● 104310			
\varnothing " d_1 UN	P TPI	d_1 mm	d_2 mm	l_1 mm			ID			
1 1/8	8	28.57	65	25	5	28.33	● 104246			
1 1/4	8	31.75	65	25	6	31.51	● 104245			
1 1/2	8	38.1	75	20	7	37.85	● 104244			
1 3/4	8	44.45	90	22	7	44.2	● 104247			







							N5120	N5120 LH						
<p>N5120  $\geq \emptyset 3$ </p> <p>N5120 LH  $\geq \emptyset 3$  </p>														
														
\emptyset " d_1 G	P TPI	d_1 mm	d_2 mm	l_1 mm			ID	ID						
1/8	28	9.7	30	11	5	9.62	● 103926							
1/4	19	13.15	38	10	5	13.03	● 103924	● 103925						
3/8	19	16.66	45	14	5	16.54	● 103935	● 103936						
1/2	14	20.95	45	14	6	20.81	● 103922	● 103923						
5/8	14	22.91	55	16	5	22.77	● 103938							
3/4	14	26.44	55	16	6	26.3	● 103933	● 103934						
7/8	14	30.2	65	18	6	30.06	● 103940							
1	11	33.24	65	18	7	33.07	● 103928							
1 1/4	11	41.91	75	20	8	41.73	● 103918							
1 1/2	11	47.8	90	22	8	47.62	● 103917							
2	11	59.61	105	22	9	59.43	● 103932							
2 1/2	11	75.18	120	22	10	74.97	● 103930							

G DIN EN ISO 228 (BSP)

Z MS
HSSE HSS

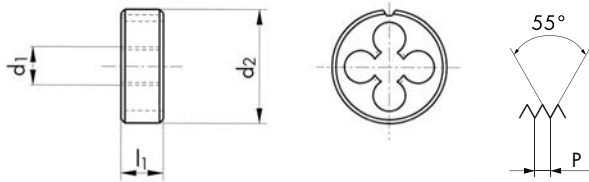







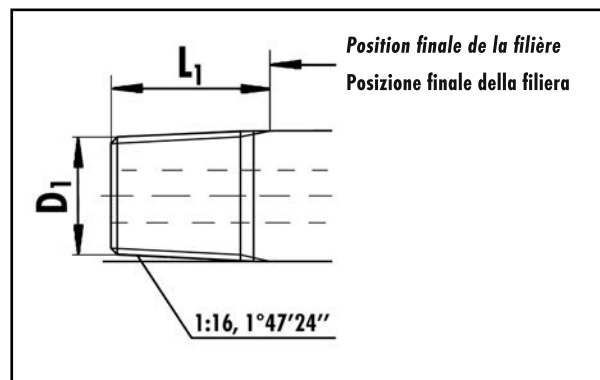



Z5120								Z5120	MS5120	MS5120
								A	A	A -0.1 mm
$\varnothing'' d_1$ G	P TPI	d_1 mm	d_2 mm	l_1 mm	Z	MS	$\rightarrow A \leftarrow$	ID	ID	ID
1/8	28	9.72	30	11	5	5	9.62	● 104761		★ 142831
1/4	19	13.15	38	10	5	5	13.03	● 104760	● 101338	★ 142832
3/8	19	16.66	45	14	5	5	16.54	● 104764	● 101342	● 119716
1/2	14	20.95	45	14	6	6	20.81	● 104759	● 101337	● 119243
3/4	14	26.44	55	16	6	6	26.3	● 104763	● 101341	● 119648
1	11	33.24	65	18	8	7	33.07	● 104762	● 101340	● 135186

N5120  					N5120
					
					 
Ø" d₁	P TPI	d₂ mm	l₁ mm		ID
1/8	28	30	11	5	● 104226
1/4	19	38	14	5	● 104225
3/8	19	45	14	5	● 104230
1/2	14	45	18	6	● 104224
3/4	14	55	22	6	● 104229
1	11	65	25	7	● 104227

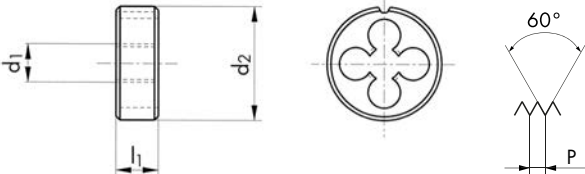
Valeurs indicatives des diamètres de tournage pour les filetages R (en mm)
Valori guida per i diametri di tornitura per i filetti R (in mm)



Ø" R	D₁ mini mm	D₁ maxi mm	D₁ (guide line) mm	L₁ (guide line) mm
1/8	9.422	9.534	9.48	8.2
1/4	12.700	12.863	12.78	12.1
3/8	16.181	16.343	16.26	12.5
1/2	20.330	20.555	20.44	16.4
3/4	25.735	25.960	25.85	17.7
1	32.455	32.743	32.60	20.9

<p>N5120  </p> <p>N5120  </p>					N5120	N5120			
					NPT	NPTF			
					 	 			
$\emptyset'' d_1$ NPT, NPTF	P TPI	d_2 mm	l_1 mm		ID	ID			
1/16	27	25	9	4	● 104194				
1/8	27	30	11	5	● 104197				
1/4	18	38	14	5	● 104196				
3/8	18	45	14	5	● 104201				
1/2	14	45	18	6	● 104195	* 104205			
3/4	14	55	22	6	● 104200				
1	11.5	65	25	7	● 104198	* 104208			
1 1/4	11.5	75	26	8	● 104193				

Valeurs indicatives des diamètres de tournage pour les filetages NPT et NPTF (en mm)
Valori guida per i diametri di tornitura per i filetti NPT e NPTF (in mm)

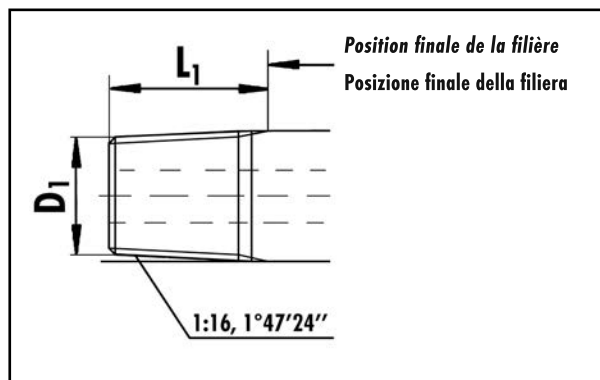

\emptyset'' NPT	D_1 mini mm	D_1 maxi mm	D_1 (guide line) mm	L_1 (guide line) mm	\emptyset'' NPTF	D_1 mini mm	D_1 maxi mm	D_1 (guide line) mm	L_1 (guide line) mm
1/16	7.521	7.643	7.58	8.4	1/16	7.525	7.617	7.57	8.4
1/8	9.866	9.988	9.93	8.5	1/8	9.870	9.962	9.92	8.5
1/4	13.099	13.255	13.18	12.7	1/4	13.129	13.215	13.17	12.7
3/8	16.518	16.674	16.60	12.9	3/8	16.548	16.634	16.59	12.9
1/2	20.551	20.713	20.63	16.8	1/2	20.617	20.703	20.66	16.8
3/4	25.866	26.028	25.95	17.1	3/4	25.932	26.018	25.98	17.1
1	32.419	32.591	32.51	21.3	1	32.475	32.561	32.52	21.3
1 1/4	41.144	41.316	41.23	21.9					

PG DIN 40430 TR DIN 103

HSS













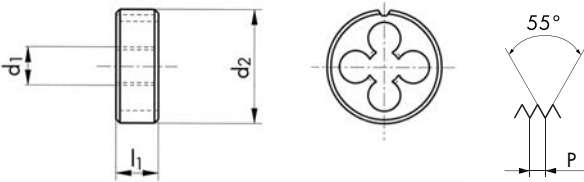

N5120							N5120	N5120			
							<div style="display: flex; justify-content: space-around;"> <div style="border: 1px solid black; padding: 5px;">PG</div> <div style="border: 1px solid black; padding: 5px;">TR</div> </div>				
$\emptyset d_1$ PG	P TPI	d_1 mm	d_2 mm	l_1 mm			ID				
7	20	12.5	38	10	5	12.4	● 104220				
9	18	15.2	38	10	5	15.1	● 104221				
11	18	18.6	45	14	5	18.5	● 104212				
13.5	18	20.4	45	14	6	20.3	● 104213				
16	18	22.5	55	16	5	22.4	● 104214				
42	16	54	90	22	10	53.85	* 104218				
48	16	59.3	105	22	9	59.15	* 104219				
Other sizes on request!											
							<div style="border: 1px solid black; padding: 5px; width: fit-content; margin: 0 auto;">7e</div>				
$\emptyset d_1$ TR	P mm	d_2 mm	l_1 mm			ID					
28	5	65	25	5	27.83	* 104240					
32	6	65	25	6	31.81	* 104242					
Other sizes on request!											

W BS 84 (BSW)

HSS



							N5120	N5120 LH		
<p>N5120  </p> <p>N5120 LH   </p>										
										
$\frac{\text{Ø}''}{W}$ d ₁	P TPI	d ₁ mm	d ₂ mm	l ₁ mm			ID	ID		
1/8	40	3.17	20	5	4	3.09	● 104320			
5/32	32	3.96	20	7	4	3.88	● 104333			
3/16	24	4.76	20	7	4	4.66	● 104325			
1/4	20	6.35	20	7	4	6.24	● 104318			
5/16	18	7.93	25	9	4	7.82	● 104331			
3/8	16	9.52	30	11	4	9.4	● 104329			
7/16	14	11.11	30	11	4	10.98	● 104336			
1/2	12	12.7	38	14	4	12.56	● 104316			
5/8	11	15.87	45	18	4	15.72	● 104334			
3/4	10	19.05	45	18	5	18.89	● 104327	* 104328		
1	8	25.4	55	22	5	25.27	● 104322			
1 3/8	6	34.92	65	25	6	34.77	* 104315			



								N5220	N5220	Z5220		
N5220												
N5220												
Z5220												
$\emptyset d_1$ M	P mm	d_2 mm	l_1 mm		TK mm			ID	ID	$6g$ - mm	ID	
1.4	0.3	16	2.6	4	12.2	1.36		● 104346				
1.6	0.35	16	2.6	4	12.2	1.54		● 104347				
2	0.4	16	3.5	4	12.2	1.93		● 104367				
2.3	0.4	16	3.5	4	12.2	2.23		● 104369				
2.5	0.45	16	3.5	4	12.2	2.43		● 104371		● 104803		
2.6	0.45	16	3.5	4	12.2	2.53		● 104372				
3	0.5	16	3.5	4	12.2	2.92	2.9	● 104375	● 104374	0.030	● 104804	
3.5	0.6	16	4	4	12.2	3.41		● 104376				
4	0.7	16	5	4	12.2	3.91	3.87	● 104380	● 104379	0.035	● 104805	
5	0.8	20	7	4	15	4.9	4.87	● 104384	● 104383	0.035	● 104806	
6	1	20	7	4	15	5.88	5.85	● 104388	● 104387	0.035	● 104807	
8	1.25	25	9	4	19	7.87	7.83	● 104397	● 104396	0.035	● 104808	
10	1.5	30	11	6	23	9.85	9.82	● 104354	● 104353	0.035		
12	1.75	30	11	6	23	11.83		● 104358				
								≤M1.4				



N5220



11 12

N5220

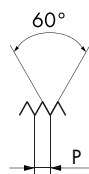
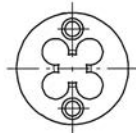
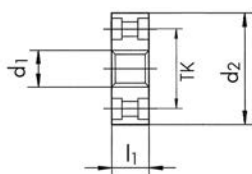

$\varnothing d_1$ MF	P mm	d_2 mm	l_1 mm		TK mm		ID
3	0.35	16	3	4	12.2	2.94	● 104373
4	0.5	16	4	4	12.2	3.93	● 104378
5	0.5	20	5	4	15	4.93	● 104382
6	0.5	20	5	4	15	5.93	● 104385
6	0.75	20	7	4	15	5.9	● 104386
7	0.5	25	7	4	19	6.93	* 104389
7	0.75	25	7	4	19	6.9	* 104390
10	0.75	30	7	6	23	9.9	* 104350
10	1.25	25	9	6	19	9.86	* 104352

N5310						N5310			
$\emptyset d_1$ M	P mm	s mm	l_1 mm		$\rightarrow 6g \leftarrow$	ID			
3	0.5	18	5	3	2.92	● 104464			
3.5	0.6	18	5	3	3.41	★ 104465			
4	0.7	18	5	3	3.91	● 104478			
4.5	0.75	18	7	3	4.41	★ 104479			
5	0.8	18	7	4	4.9	● 104487			
6	1	18	7	4	5.88	● 104493			
8	1.25	21	9	4	7.87	● 104502			
9	1.25	21	9	5	8.87	★ 104503			
10	1.5	27	11	4	9.85	● 104438			
12	1.75	36	14	4	11.83	● 104443			
14	2	36	14	4	13.82	● 104445			
16	2	41	18	4	15.82	● 104447			
18	2.5	41	18	5	17.79	● 104450			
20	2.5	41	18	5	19.79	● 104453			
22	2.5	50	22	5	21.79	● 104456			
24	3	50	22	5	23.76	● 104459			
30	3.5	60	25	5	29.73	● 104468			
$\emptyset d_1$ MF	P mm	s mm	l_1 mm		$\rightarrow 6g \leftarrow$	ID			
6	0.75	18	7	4	5.9	★ 104492			
8	0.75	21	9	4	7.9	★ 104500			
8	1	21	9	4	7.88	★ 104501			
12	1	36	10	4	11.88	★ 104440			
27	1.5	60	18	6	26.85	★ 104461			
33	1.5	60	18	7	32.85	★ 104469			
39	1.5	70	20	8	38.85	★ 104476			

G DIN EN ISO 228 (BSP)

W BS 84 (BSW)

M ISO DIN 13

HSS



							N5310	N5310		N5420		
N5310												
N5310												
N5420												
Ø" d ₁ G	P TPI	d ₁ mm	s mm	l ₁ mm			ID					
1/4	19	13.15	36	10	5	13.03	● 104428					
3/8	19	16.66	41	14	5	16.54	● 104433					
1/2	14	20.95	41	14	6	20.81	● 104427					
5/8	14	22.91	50	16	6	22.77	★ 104434					
3/4	14	26.44	50	16	6	26.3	● 104432					
7/8	14	30.2	60	18	6	30.06	★ 104435					
1	11	33.24	60	18	7	33.07	● 104430					
1 3/8	11	44.32	85	22	7	44.14	★ 104426					
1 3/4	11	53.74	100	22	8	53.57	★ 104425					
Ø" d ₁ W	P TPI	d ₁ mm	s mm	l ₁ mm			ID					
1/8	40	3.17	18	5	3	3.09	★ 104512					
3/16	24	4.76	18	7	3	4.66	★ 104515					
9/16	12	14.28	36	14	4	14.14	★ 104522					
1 3/8	6	34.92	60	25	6	34.77	★ 104508					
1 1/2	6	38.1	70	30	6	37.95	★ 104504					
1 3/4	5	44.45	85	36	6	44.28	★ 104507					
2	4.5	50.8	85	36	7	50.63	★ 104514					
Ø d ₁ M	P mm	d ₂ mm	l ₁ mm			ID						
2.5	0.45	16	8	4	2.43	★ 104527						
3.5	0.6	16	9.5	4	3.41	★ 104530						
8	1.25	25	14	5	7.86	★ 104535						

JAUGES DE FILETAGE DE PRÉCISION — CALIBRI FILETTATI DI PRECISIONE

D5703



Tampon de filetage "Entre" et "N'entre pas"

Dimensions selon DIN 2280 jusqu'au diamètre nominal 40 mm

Calibro a tampone filettati "Passa" e "Non passa"

Dimensioni secondo DIN 2280 fino al diametro nominale 40 mm

D5701-1



Tampon de filetage "Entre"

dimensions selon DIN 2281-1;

dès diamètre nominal 40 mm selon DIN 2281-2

Calibro a tampone filettati "Passa"

dimensioni secondo DIN 2281-1;

sopra il diametro nominale 40 mm secondo DIN 2281-2

D5701-2



Tampon de filetage "N'entre pas"

dimensions selon DIN 2283-1;

dès diamètre nominal 40 mm selon DIN 2283-2

Calibro a tampone filettati "Non passa"

dimensioni secondo DIN 2283-1;

sopra il diametro nominale 40 mm secondo DIN 2283-2

D5720



Tampon de filetage "Entre" et "N'entre pas" conique

avec étage de mesure

Calibro a tampone filettati "Passa" e "Non passa" conico

con limite di misurazione

Information importante

DC SWISS SA est spécialisée dans la fabrication de jauges tampons filettées à pas extrêmement fins, comme celles fréquemment utilisées dans l'industrie horlogère, notamment pour le contrôle des filetages intérieurs des boîtes de montres.

Sur demande, nous vous soumettrons volontiers une offre appropriée.

Informazione importante

DC SWISS SA è specializzata nella produzione di tamponi di controllo per filettature estremamente fini, come quelle frequentemente utilizzate nell'industria orologiera, soprattutto per il controllo delle filettature interne delle casse degli orologi.

Su richiesta saremo lieti di sottoporvi un'offerta adeguata.



JAUGES DE FILETAGE DE PRÉCISION — CALIBRI FILETTATI DI PRECISIONE

D5704



Jauge bague de filetage "Entre"

dimensions selon DIN 2285-1

Calibro ad anello filettati "Passa"

dimensioni secondo DIN 2285-1

D5714



Jauge bague de filetage "N'entre pas"

dimensions selon DIN 2299-1

Calibro ad anello filettati "Non passa"

dimensioni secondo DIN 2299-1

D5721



Jauge bague de filetage "Entre" et "N'entre pas" pour filetage extérieur conique

avec étage de mesure

Calibro ad anello filettati "Passa" e "Non passa" per filettatura esterna conica

con limite di misurazione

Jauges de filetage livrables du stock sans certificat de contrôle.

Sur demande, ces jauges peuvent être livrées avec certificat dans un bref délai.

Pour nouvelles jauges de filetage / insécurité de mesure U95.

Les jauges avec certificat sont livrées avec marquage du numéro d'identification figurant sur le certificat.













I calibri filettati sono disponibili a magazzino senza certificato di prova.

Su richiesta, questi calibri possono essere consegnati con breve preavviso con un certificato di prova.













Per nuovi calibri filettati / incertezza della misura U95.

Tutti i calibri filettati certificati sono contrassegnate con il numero di identificazione del certificato corrispondente.





Répertoire — Tampons de filetage, jauges bagues de filetage
Rubrica — Calibri a tampone e ad anello filettati

Caractéristiques Caratteristiche							
							
Type Tipo		D5701-1	D5701-2	D5703	D5720	D5722	D5725
M 6H / 6g	ISO DIN 13	294	294	294			
M 6G / 6e	ISO DIN 13			294			
M 6H / 6g LH	ISO DIN 13			294			
MF 6H / 6g	ISO DIN 13	296 - 297	297	296 - 297			
MF 6G / 6e	ISO DIN 13			296			
MF 6H / 6g LH	ISO DIN 13			296			
UNC	ASME B1.1	300		300			
UNF	ASME B1.1	301		301			
UNEF	ASME B1.1			301			
NPT	ASME B1.20.1				303		
NPTF	ANSI B1.20.3				303		
G (BSP)	DIN EN ISO 228	302	302	302			
PG	DIN 40430						302
EG M	ISO DIN 8140			304			
EG UNC	ASME B18.29.1			304			
EG UNF	ASME B18.29.1			304			

M ISO DIN 13 DIN ISO 1502

		D5701-1	D5701-2	D5703	D5703 LH	D5703	
D5701-1	M1 - M1.4 = 						
D5703	M1 - M1.4 = 				 		
$\emptyset d_1$ M	P mm	ID	ID	ID	ID	ID	
1	0.25			● 100242			
1.1	0.25			● 100243			
1.2	0.25			● 100244			
1.4	0.3			● 100245			
1.6	0.35			● 100246			
1.7	0.35			● 100247			
1.8	0.35			● 100248			
2	0.4			● 100278	● 105159	● 104982	
2.2	0.45			● 100280			
2.3	0.4			● 100281			
2.5	0.45			● 100283	● 105160	● 104979	
2.6	0.45			● 100285			
3	0.5			● 100310	● 104964	● 104976	
3.5	0.6			● 100312		● 104977	
4	0.7			● 100333	● 104966	● 104978	
4.5	0.75	* 100114					
5	0.8			● 100348	● 104967	● 104980	
6	1			● 100363	● 104968	● 104981	
7	1			● 100369			
8	1.25			● 100373	● 104969	● 104983	
9	1.25			● 100375			
10	1.5			● 100253	● 104970	● 104984	
11	1.5			* 100256			
12	1.75			● 100261	● 104971	● 104985	
14	2	* 100045		● 100266		● 104986	
16	2			● 100271	● 104973	● 104987	
18	2.5	* 100055		● 100276		* 104988	
20	2.5	* 100068		● 100289	● 104975	● 104989	
22	2.5	* 100072		● 100293	* 110178		
24	3	* 100076		● 100297	● 110179		
27	3			● 100305			
30	3.5			● 100316			
33	3.5	* 100101		● 100322			
36	4	* 100107		● 100328			
39	4	* 100109		● 100330			
42	4.5	● 100119	● 142843				
45	4.5	● 100122	● 142844				
48	5	● 100125	● 142845				
52	5	● 100132	● 142846				
56	5.5	● 100137	● 142847				



M ISO DIN 13 DIN ISO 1502

		D5704	D5704 LH	D5704	D5714	D5714		
D5704	M1 - M1.4 = 							
D5714	M1 - M1.4 = 							 LH
$\emptyset d_1$ M	P mm	ID	ID	ID	ID	ID		
1	0.25	● 100480			● 110419			
1.2	0.25	● 100481			● 110420			
1.4	0.3	● 100482			● 110421			
1.6	0.35	● 100483			● 110422			
1.7	0.35	● 100484			● 111439			
1.8	0.35	● 100485			● 110423			
2	0.4	● 100515	● 105006		● 100734			
2.2	0.45	● 100517			● 100735			
2.3	0.4	● 100518			● 100736			
2.5	0.45	● 100520			● 100737			
2.6	0.45	● 100522			● 100738			
3	0.5	● 100547	● 105001		● 100763			
3.5	0.6	● 100549	● 110302	* 110301	● 100765	* 142836		
4	0.7	● 100570	● 105003		● 100774			
5	0.8	● 100585	● 105004	* 104993	● 100778	* 143406		
6	1	● 100600	● 105005	* 104994	● 100781	* 135556		
7	1	● 100605		* 104995	● 100783			
8	1.25	● 100611	● 105007		● 100786			
9	1.25	● 100610			● 100788			
10	1.5	● 100490	● 105008		● 100711	* 142842		
11	1.5				* 100713			
12	1.75	● 100498	● 105009		● 100718			
14	2	● 100503	● 105010		● 100723			
16	2	● 100508	● 105011		● 100728			
18	2.5	● 100513	● 105012		● 100733			
20	2.5	● 100526	● 105013		● 100742			
22	2.5	● 100530	● 110298		● 100746			
24	3	● 100534			● 100750			
27	3	● 100542			● 100758			
30	3.5	● 100553			● 100769			
33	3.5	* 100559			* 100770			
39	4				* 110440			
45	4.5				* 110448			
56	5.5	* 100595			* 110461			

MF ISO DIN 13 DIN ISO 1502





		D5701-1	D5703	D5703 LH	D5703		
							
		6H	6H	6H	LH	6G	
Ø d ₁ MF	P mm	ID	ID	ID	ID		
2.5	0.35		● 100282				
3	0.35		● 100309				
4	0.35		● 100331				
4	0.5		● 100332				
5	0.5		● 100347	● 105016	● 105045		
6	0.5	* 100140	● 100361	● 110184			
6	0.75		● 100362		● 105046		
7	0.5		● 100367				
7	0.75	* 100147	● 100368				
8	0.5	* 100149	● 100370				
8	0.75		● 100371	● 105018	● 105047		
8	1	* 100151	● 100372	● 105019	● 105048		
9	1		● 100374				
10	0.5		● 100249				
10	0.75		● 100250				
10	1		● 100251	● 105020	● 105049		
10	1.25	* 100031	● 100252				
11	1	* 100034	● 100255				
12	0.75	* 100036	● 100257				
12	1		● 100258	● 105021	● 105050		
12	1.25		● 100259				
12	1.5		● 100260	● 105022			
14	1		● 100263	● 110171			
14	1.25		● 100264				
14	1.5		● 100265	● 105023	● 105052		
15	1		● 100267				
15	1.5		● 100268				
16	1		● 100269	● 110172			
16	1.5		● 100270	● 105024	● 105053		
17	1		● 100272				
18	1		● 100273				
18	1.5		● 100274	● 105025	● 105054		
18	2	* 100054	● 100275				
20	1	* 100065	● 100286				
20	1.5		● 100287	● 105026			
20	2	* 100067	● 100288		* 110176		
22	1		● 100290				
22	1.5		● 100291	● 110177			
22	2		● 100292				
24	1		● 100294				
24	1.5		● 100295				
24	2		● 100296				

MF ISO DIN 13 DIN ISO 1502

		D5701-1	D5701-2	D5703			
							
							
$\emptyset d_1$ MF	P mm	ID	ID	ID			
25	1			● 100298			
25	1.5			● 100299			
25	2			● 100300			
26	1			● 100301			
26	1.5	* 100081		● 100302			
27	1.5	* 100082		● 100303			
27	2	* 100083		● 100304			
28	1			● 100306			
28	1.5	* 100086		● 100307			
28	2	* 100087		● 100308			
30	1	* 100092		● 100313			
30	1.5			● 100314			
30	2			● 100315			
32	1			● 100317			
32	1.5			● 100318			
32	2			● 100319			
33	1.5			● 100320			
33	2			● 100321			
35	1.5			● 100323			
36	1.5			● 100325			
36	2			● 100326			
36	3			● 100327			
38	1.5	* 100108		● 100329			
40	1.5			● 100336			
40	2			● 100337			
42	1.5	● 100117	● 142848				
42	2	● 100118	● 142849				
45	1.5	● 100120	● 110127				
45	2	● 100121	● 142851				
48	1.5	● 100123	● 123180				
48	2	● 100124	● 142853				
50	1.5	● 100128	● 142854				
50	2	● 100129	● 142855				
52	1.5	● 100130	● 123428				
52	2	● 100131	● 142857				
55	1.5		● 123468				
55	2	● 100134	● 142859				
56	1.5	● 100135	● 142860				
56	2	● 100136	● 142861				
58	1.5	● 100138	● 142862				
58	2	● 100139	● 142863				
60	1.5	● 100143	● 142864				
60	2	● 100144	● 142865				





		D5704	D5704 LH	D5714			
							
		6g	6g	LH	6g		
Ø d ₁ MF	P mm	ID	ID	ID			
2.5	0.35	● 100519		● 110427			
3	0.35	● 100546		● 100762			
3.5	0.35	● 100548		● 100764			
4	0.35	● 100568		● 100772			
4	0.5	● 100569		● 100773			
4.5	0.5	● 100571		● 100775			
5	0.5	● 100584	● 105057	● 100777			
6	0.5	● 100598	● 110307	● 100779			
6	0.75	● 100599	● 105058	● 100780			
7	0.5	● 100603		● 110467			
7	0.75	● 100604		● 100782			
8	0.5	● 100606					
8	0.75	● 100607	* 105059	● 100784			
8	1	● 100608	● 105060	● 100785			
9	1	● 100609		● 100787			
10	0.5	● 100486		● 100707			
10	0.75	● 100487		● 100708			
10	1	● 100488	● 105061	● 100709			
10	1.25	● 100489		● 100710			
11	1	● 100492		● 100712			
12	0.75	● 100494		● 100714			
12	1	● 100495	● 105062	● 100715			
12	1.25	● 100496		● 100716			
12	1.5	● 100497	● 105063	● 100717			
13	1	● 100499		● 100719			
14	1	● 100500	● 110290	● 100720			
14	1.25	● 100501		● 100721			
14	1.5	● 100502	● 105064	● 100722			
15	1	● 100504		● 100724			
15	1.5	● 100505		● 100725			
16	1	● 100506	● 110292	● 100726			
16	1.5	● 100507	● 105065	● 100727			
17	1	● 100509		● 100729			
18	1	● 100510		● 100730			
18	1.5	● 100511	● 105066	● 100731			
20	1	● 100523	● 110295	● 100739			
20	1.5	● 100524	● 105067	● 100740			
20	2	● 100525		● 100741			
22	1	● 100527		● 100743			
22	1.5	● 100528		● 100744			
22	2	● 100529		● 100745			
24	1	● 100531		● 100747			
24	1.5	● 100532		● 100748			
24	2	● 100533					

		D5704	D5714				
							
		6g	6g				
$\varnothing d_1$ MF	P mm	ID	ID				
25	1	● 100535					
25	1.5	● 100536					
26	1	● 100538					
26	1.5	● 100539					
27	1.5	● 100540					
27	2	● 100541	* 100757				
28	1	● 100543					
28	1.5	● 100544	* 100760				
30	1	● 100550					
30	1.5	● 100551					
30	2	● 100552					
32	1	● 100554					
32	1.5	● 100555					
32	2	● 100556					
33	1.5	● 100557					
33	2	● 100558	* 110433				
35	1.5	● 100560					
36	1.5	● 100562					
36	2	● 100563					
36	3	● 100564					
38	1.5	● 100566					
40	1.5	● 100573					
42	1.5	● 100575					
42	2	● 100576					
45	1.5	● 100578					
45	2	● 100579					
48	1.5	● 100581	* 110449				
48	2	● 100582					
50	1.5	● 100586					
50	2	● 100587	* 110453				
52	1.5		* 110454				
52	2	● 100589					
55	1.5	● 100591					
55	2	● 100592	* 110458				
56	1.5	● 100593	* 110459				
56	2		* 110460				
58	1.5	● 100596					
58	2	● 100597	* 110463				
60	1.5	● 100601					
60	2	● 105014					

		D5701-1	D5703	D5704	D5714		
							
							
Ø" d ₁ UNC	P TPI	ID	ID	ID	ID		
1	64		● 100408	● 110347	● 110473		
2	56		● 100414	● 110353	● 110479		
3	48		● 100416				
4	40	* 110080	● 110224	● 110357	● 110483		
5	40		● 100420				
6	32	* 110084	● 100423	● 110361	● 110487		
8	32		● 100426	● 110364	● 110490		
10	24	* 110074	● 100412	● 110351	● 110477		
12	24		● 100413				
1/4	20		● 100410	● 110349	● 110475		
5/16	18	* 110082	● 100421	● 110359	● 110485		
3/8	16	* 110079	● 100418	● 110356	● 110482		
7/16	14	* 110085	● 100424	● 110362	● 110488		
1/2	13	* 110071	● 100409	● 110348	● 110474		
9/16	12		● 100427	● 110365	* 110491		
5/8	11		● 100422	● 110360			
3/4	10	* 110078	● 100417	● 110355	* 110481		
7/8	9		● 100425	● 110363	* 110489		
1	8	* 110073	● 100411	● 110350	* 110476		
1 1/8	7	* 110068	● 100405	* 110345	* 110471		
1 1/4	7	* 110067	● 100404	* 110344	* 110470		
1 3/8	6	* 110069	● 100407	* 110346	* 110472		
1 1/2	6	* 110066	● 100403	* 110343	* 110469		

UNF, UNEF

ASME B1.1
ANSI / ASME B1.2

		D5701-1	D5703	D5704	D5714		
							
							
Ø" d ₁ UNF	P TPI	ID	ID	ID	ID		
0	80		● 110246				
1	72		● 110251	● 110383	● 110508		
2	64		● 110256	● 110389	● 110514		
3	56		● 110257	● 110390	● 110515		
4	48		● 110260	● 110393	● 110518		
5	44	* 110116					
6	40		● 110264				
8	36	* 110122	● 110267				
10	32		● 110254	● 110387	● 110512		
12	28		● 110255	● 110388	● 110513		
1/4	28	* 110107	● 110006	● 110385	● 110510		
5/16	24	* 110117	● 110262	● 110395	● 110520		
3/8	24	* 110114	● 110259	● 110392	● 110517		
7/16	20	* 110120	● 110265	● 110398	● 111440		
1/2	20	* 110106	● 110252	● 110384	● 110509		
9/16	18		● 110268	● 110401			
5/8	18		● 110263	● 110396			
3/4	16		● 110258	● 110391			
7/8	14		● 110266	● 110399			
1	12		● 128646	● 110386			
1 1/8	12	* 110103	● 110249	● 110381			
1 1/4	12		● 110248	● 110380	* 110505		
1 3/8	12	* 110104	● 110250		* 110507		
1 1/2	12		● 110247	● 110379			
Ø" d ₁ UNEF	P TPI	ID	ID	ID			
12	32		● 110238				
1/4	32		● 110236	● 110368	● 110493		
5/16	32		● 110241	● 110373	● 110498		
3/8	32		● 110240	● 110372	● 110497		
7/16	28		● 110243	● 110375	● 110500		
1/2	28		● 110235	● 110367	● 110492		
9/16	24		● 110245	● 110377	● 110502		
5/8	24		● 110242	● 110374	● 110499		
3/4	20		● 110239	● 110371	● 110496		
7/8	20		● 110244				
1	20		● 110253	● 110369	● 110494		





G DIN EN ISO 228 (BSP)
DIN EN ISO 228-2

PG DIN 40430
DIN 40431

		D5701-1	D5701-2	D5703	D5704	D5714	D5725
\emptyset " d ₁ G	P TPI	ID	ID	ID	ID	ID	ID
1/8	28	* 110044		● 110009	● 110277	● 110408	
1/4	19			● 110003	● 110276	● 110407	
3/8	19	* 110052		● 110162	● 110284	● 110415	
1/2	14			● 110001	● 110275	● 110406	
5/8	14			● 110164	● 110286	● 110417	
3/4	14			● 110161	● 110283	● 110414	
7/8	14	* 110054		● 110165			
1	11			● 110156	● 110278	● 110409	
1 1/8	11			● 110154		* 110404	
1 1/4	11	● 110041	● 119459		● 110272		
1 1/2	11	● 110040	● 119429		● 110271		
1 3/4	11	● 110043	● 142868		● 110274	* 110405	
2	11	● 110050	● 110126		● 110282		
2 1/4	11					* 110411	
2 1/2	11		* 110125				
2 3/4	11					* 110412	
\emptyset d ₁ PG	P TPI	ID				ID	
7	20					● 110216	
9	18					● 110217	
11	18					● 110205	
13.5	18					● 110209	
16	18					● 110210	
21	16					* 110331	● 110211
29	16						● 110212

NPT ASME B1.20.1 ASME B1.20.1

NPTF ANSI B1.20.3 ASA B2.2





		D5720	D5721				
		 					
		 					
Ø" d ₁ NPT	P TPI	ID	ID				
1/16	27	● 110190	● 110313				
1/8	27	● 110193	● 110316				
1/4	18	● 110192	● 110315				
3/8	18	● 110197	● 110320				
1/2	14	● 110191	● 110314				
3/4	14	● 110196	● 110319				
1	11.5	● 110194	● 110317				
1 1/4	11.5	● 110189	● 110312				
1 1/2	11.5	● 110188	● 110311				
2	11.5	● 110195	● 110318				
Ø" d ₁ NPTF	P TPI	ID	ID				
1/8	27	● 110201					
1/4	18	● 110200	* 110323				
3/8	18	● 110204					
1/2	14	● 110199	* 110322				
3/4	14	● 110203	* 110326				
1	11.5	● 110202	* 110325				

EG M

ISO DIN 8140-2
DIN ISO 1502

EG UNC, EG UNF

ASME B18.29.1
~ ISO 1502

		D5703	D5703	D5703			
							
							
\emptyset d, EG M	P mm	ID					
2.5	0.45	● 110132					
3	0.5	● 110133					
4	0.7	● 110134					
5	0.8	● 110135					
6	1	● 110136					
8	1.25	● 110137					
10	1.5	● 110128					
12	1.75	● 110129					
16	2	● 110131					
\emptyset " d, EG UNC	P TPI	ID					
4	40	● 170252					
6	32	● 170253					
8	32	● 170254					
10	24	● 170255					
1/4	20	● 170256					
5/16	18	● 170257					
3/8	16	● 170258					
\emptyset " d, EG UNF	P TPI	ID					
6	40	● 170259					
8	36	● 170260					
10	32	● 161020					
1/4	28	● 151790					
5/16	24	● 170261					
3/8	24	● 160134					













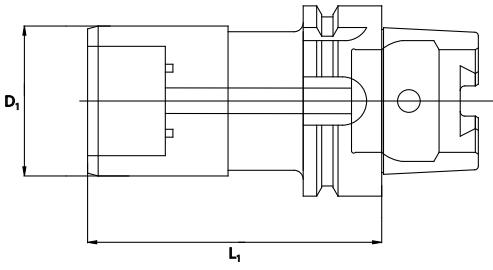









SRT 312  SYNCHRO

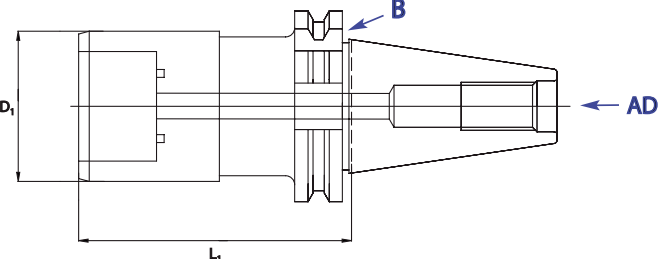

SRT Mandrins de taraudage avec amortisseur axial

Mandrini di maschiatura con ammortizzatore assiale

 Uniquement pour taraudage synchrone
Nur für Synchronbearbeitung
Only for rigid tapping
Solo per maschiatura sincrona
Solo para roscado sincronizado
Только для rigid tapping

DIN 69 893 A	SRT-HSK63-312	SRT-HSK63-820	SRT-HSK63-1433			
<h1>HSK</h1>						
						
						
D₁ mm	L₁ mm					
ID	ID	ID				
M3 - M12	36	72	HSK A 63 S1	● 170111		
M8 - M20	53	89	HSK A 63 S2		● 170112	
M14 - M33	78	121	HSK A 63 S3			● 170114
MAS/BT Form AD + B				SRT-BT40-312	SRT-BT40-820	SRT-BT40-1433
<h1>BT</h1>						
						
						
D₁ mm	L₁ mm					
ID	ID	ID				
M3 - M12	36	71	BT40 S1	● 170133		
M8 - M20	53	85	BT40 S2		● 170134	
M14 - M33	78	121	BT40 S3			● 170135

SRT Mandrins de taraudage avec amortisseur axial

Mandrini di maschiatura con ammortizzatore assiale











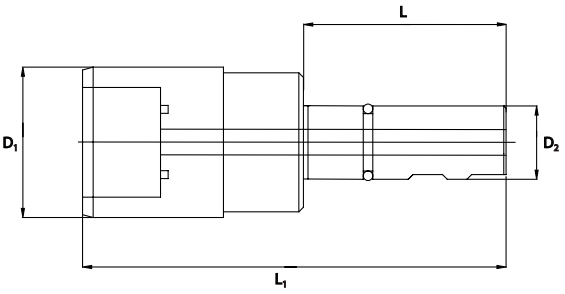













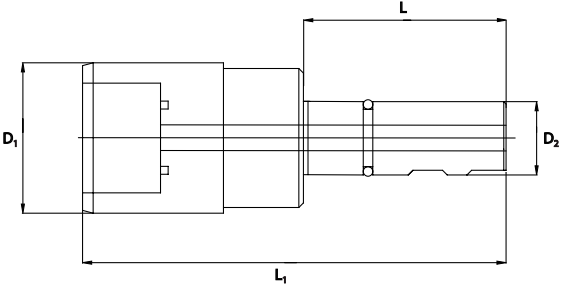

SYNCHRO Uniquement pour taraudage synchrone
 Nur für Synchronbearbeitung
 Only for rigid tapping
 Solo per maschiatura sincrona
 Solo para roscado sincronizado
 Только для rigid tapping

DIN 69 871 Form AD + B	SRT-SK40-312	SRT-SK40-820	SRT-SK40-1433																				
<h1>SK</h1>																							
	< 50 bar	< 50 bar	< 50 bar																				
<table border="1"> <thead> <tr> <th>D_1 mm</th> <th>L_1 mm</th> <th></th> <th></th> <th>310</th> </tr> </thead> <tbody> <tr> <td>M3 - M12</td> <td>36 65</td> <td>SK40</td> <td>S1</td> <td></td> </tr> <tr> <td>M8 - M20</td> <td>53 79</td> <td>SK40</td> <td>S2</td> <td></td> </tr> <tr> <td>M14 - M33</td> <td>78 115</td> <td>SK40</td> <td>S3</td> <td></td> </tr> </tbody> </table>	D_1 mm	L_1 mm			310	M3 - M12	36 65	SK40	S1		M8 - M20	53 79	SK40	S2		M14 - M33	78 115	SK40	S3		ID	ID	ID
D_1 mm	L_1 mm			310																			
M3 - M12	36 65	SK40	S1																				
M8 - M20	53 79	SK40	S2																				
M14 - M33	78 115	SK40	S3																				
	● 170124	● 170125	● 170126																				
DIN 69 871 Form AD + B	SRT-SK50-820	SRT-SK50-1433	SRT-SK50-2248																				
<h1>SK</h1>																							
	< 50 bar	< 50 bar	< 50 bar																				
<table border="1"> <thead> <tr> <th>D_1 mm</th> <th>L_1 mm</th> <th></th> <th></th> <th>310</th> </tr> </thead> <tbody> <tr> <td>M8 - M20</td> <td>53 79</td> <td>SK50</td> <td>S2</td> <td></td> </tr> <tr> <td>M14 - M33</td> <td>78 115</td> <td>SK50</td> <td>S3</td> <td></td> </tr> <tr> <td>M22 - M48</td> <td>96 170</td> <td>SK50</td> <td>S4</td> <td></td> </tr> </tbody> </table>	D_1 mm	L_1 mm			310	M8 - M20	53 79	SK50	S2		M14 - M33	78 115	SK50	S3		M22 - M48	96 170	SK50	S4		ID	ID	ID
D_1 mm	L_1 mm			310																			
M8 - M20	53 79	SK50	S2																				
M14 - M33	78 115	SK50	S3																				
M22 - M48	96 170	SK50	S4																				
	● 170128	● 170129	● 170130																				

SRT Mandrins de taraudage avec amortisseur axial



Mandrini di maschiatura con ammortizzatore assiale

 Uniquement pour taraudage synchrone
 Nur für Synchronbearbeitung
 Only for rigid tapping
 Solo per maschiatura sincrona
 Solo para roscado sincronizado
 Только для rigid tapping

DIN 1835 B	SRT-1D20-312	SRT-1D25-312	SRT-2D25-820																												
<h1>SRT</h1>																															
	 	 	 																												
<table border="1"> <thead> <tr> <th></th> <th>D₁ mm</th> <th>D₂ mm</th> <th>L mm</th> <th>L₁ mm</th> <th></th> <th></th> </tr> </thead> <tbody> <tr> <td>M3 - M12</td> <td>36</td> <td>20</td> <td>51</td> <td>97</td> <td>S1</td> <td></td> </tr> <tr> <td>M3 - M12</td> <td>36</td> <td>25</td> <td>57</td> <td>103</td> <td>S1</td> <td></td> </tr> <tr> <td>M8 - M20</td> <td>53</td> <td>25</td> <td>57</td> <td>131</td> <td>S2</td> <td></td> </tr> </tbody> </table>		D ₁ mm	D ₂ mm	L mm	L ₁ mm			M3 - M12	36	20	51	97	S1		M3 - M12	36	25	57	103	S1		M8 - M20	53	25	57	131	S2		ID	ID	ID
	D ₁ mm	D ₂ mm	L mm	L ₁ mm																											
M3 - M12	36	20	51	97	S1																										
M3 - M12	36	25	57	103	S1																										
M8 - M20	53	25	57	131	S2																										
	● 170140	● 170020	● 170141																												
DIN 1835 B	SRT-2D32-820	SRT-3D25-1433	SRT-3D32-1433																												
<h1>SRT</h1>																															
	 	 	 																												
<table border="1"> <thead> <tr> <th></th> <th>D₁ mm</th> <th>D₂ mm</th> <th>L mm</th> <th>L₁ mm</th> <th></th> <th></th> </tr> </thead> <tbody> <tr> <td>M8 - M20</td> <td>53</td> <td>32</td> <td>61.5</td> <td>135.5</td> <td>S2</td> <td></td> </tr> <tr> <td>M14 - M33</td> <td>78</td> <td>25</td> <td>57</td> <td>164.5</td> <td>S3</td> <td></td> </tr> <tr> <td>M14 - M33</td> <td>78</td> <td>32</td> <td>61.5</td> <td>169</td> <td>S3</td> <td></td> </tr> </tbody> </table>		D ₁ mm	D ₂ mm	L mm	L ₁ mm			M8 - M20	53	32	61.5	135.5	S2		M14 - M33	78	25	57	164.5	S3		M14 - M33	78	32	61.5	169	S3		ID	ID	ID
	D ₁ mm	D ₂ mm	L mm	L ₁ mm																											
M8 - M20	53	32	61.5	135.5	S2																										
M14 - M33	78	25	57	164.5	S3																										
M14 - M33	78	32	61.5	169	S3																										
	● 170142	● 170143	● 170144																												

SRT *Inserts sans accouplement de sécurité* Pinze a cambio rapido senza frizione

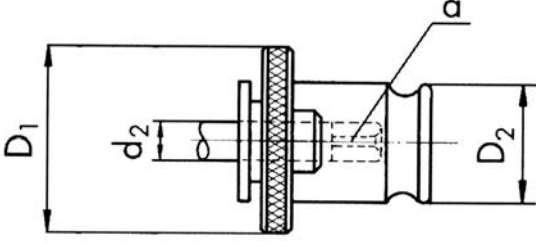
 Uniquement pour taraudage synchrone
Nur für Synchronbearbeitung
Only for rigid tapping
Solo per mescolature sincrone
Solo para roscado sincronizado
Только для rigid tapping

<h1>SRT</h1>					S1-	S2-	S3-	S4-
								
No	D ₁ mm	D ₂ mm	d ₂ mm	a mm	ID	ID	ID	ID
S1-0028	30	19	2.8	2.1	● 129915			
S1-0035	30	19	3.5	2.7	● 129916			
S1-0045	30	19	4.5	3.4	● 129918			
S1-0060	30	19	6	4.9	● 129920			
S1-0070	30	19	7	5.5	● 129921			
S1-0080	30	19	8	6.2	● 129922			
S1-0090	30	19	9	7	● 129923			
S1-0100	30	19	10	8	● 129924			
S1-0110	30	19	11	9	● 129925			
S2-0060	48	31	6	4.9		● 129927		
S2-0070	48	31	7	5.5		● 129928		
S2-0080	48	31	8	6.2		● 129929		
S2-0090	48	31	9	7		● 129930		
S2-0100	48	31	10	8		● 129931		
S2-0110	48	31	11	9		● 148303		
S2-0120	48	31	12	9		● 129932		
S2-0140	48	31	14	11		● 129933		
S2-0160	48	31	16	12		● 129934		
S2-0180	48	31	18	14.5		● 151355		
S3-0110	70	48	11	9			● 170145	
S3-0120	70	48	12	9			● 170146	
S3-0140	70	48	14	11			● 170147	
S3-0160	70	48	16	12			● 170148	
S3-0180	70	48	18	14.5			● 170149	
S3-0200	70	48	20	16			● 170150	
S3-0220	70	48	22	18			● 170151	
S3-0250	70	48	25	20			● 170152	
S4-0180	96	60	18	14.5				● 170153
S4-0200	96	60	20	16				● 170154
S4-0220	96	60	22	18				● 170155
S4-0250	96	60	25	20				● 170156
S4-0280	96	60	28	22				● 170157
S4-0320	96	60	32	24				● 170158
S4-0360	96	60	36	29				● 170159

CLASSIC

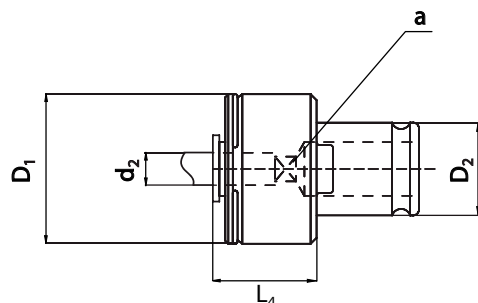

SC1-

SC2-

SC3-

SC4-



No	D ₁ mm	D ₂ mm	d ₂ mm	a mm	L ₄ mm	ID	ID	ID	ID
SC1-0028	32	19	2.8	2.1	25	● 170160			
SC1-0035	32	19	3.5	2.7	25	● 170161			
SC1-0045	32	19	4.5	3.4	25	● 170162			
SC1-0060	32	19	6	4.9	25	● 170163			
SC1-0070	32	19	7	5.5	25	● 170164			
SC1-0080	32	19	8	6.2	25	● 170165			
SC1-0090	32	19	9	7	25	● 170166			
SC1-0100	32	19	10	8	25	● 170167			
SC2-0060	50	31	6	4.9	34		● 170168		
SC2-0070	50	31	7	5.5	34		● 170169		
SC2-0080	50	31	8	6.2	34		● 170170		
SC2-0090	50	31	9	7	34		● 170171		
SC2-0100	50	31	10	8	34		● 170172		
SC2-0110	50	31	11	9	34		● 170173		
SC2-0120	50	31	12	9	34		● 170174		
SC2-0140	50	31	14	11	34		● 170175		
SC2-0160	50	31	16	12	34		● 170176		
SC2-0180	50	31	18	14.5	34		● 170177		
SC3-0110	72	48	11	9	45			● 170178	
SC3-0120	72	48	12	9	45			● 170179	
SC3-0140	72	48	14	11	45			● 170180	
SC3-0160	72	48	16	12	45			● 170181	
SC3-0180	72	48	18	14.5	45			● 170182	
SC3-0200	72	48	20	16	45			● 170183	
SC3-0220	72	48	22	18	45			● 170184	
SC3-0250	72	48	25	20	45			● 170185	
SC4-0180	96	60	18	14.5	68				● 170186
SC4-0200	96	60	20	16	68				● 170187
SC4-0220	96	60	22	18	68				● 170188
SC4-0250	96	60	25	20	68				● 170189
SC4-0280	96	60	28	22	68				● 170190
SC4-0320	96	60	32	24	68				● 170191
SC4-0360	96	60	36	29	68				● 170192

TABELLE D'UTILISATION — TABELLA D'IMPIEGO

Cycle de programmation pour mèches à centrer C315VS

Ciclo di programmazione per punte da centro C315VS

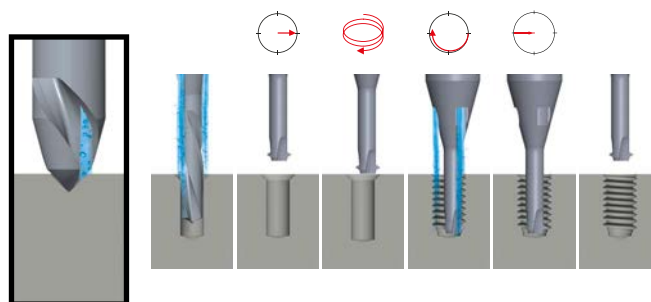

DC Classification des matières

DC Classificazione dei materiali

Groupes de matières Gruppi di materiali	Désignation des matières	Designazione dei materiali	Dureté Durezza (HB)	Résistance Resistenza Rm (N/mm ²)	Lubrifiant Lubrificante A (%)
10 Aciers Acciai	11 Aciers de décolletage	Acciai da tornitura	< 200	< 700	O E
	12 Aciers de construction ou de cémentation	Acciai da costruzione / da cementazione	< 200	< 700	O E
	13 Aciers au carbone	Acciai al carbonio	< 300	< 1000	O E
	14 Aciers alliés < 850 N/mm ²	Acciai legati < 850 N/mm ²	< 250	< 850	O E
	15 Aciers alliés / traités > 850 - < 1150 N/mm ²	Acciai legati / trattati > 850 - < 1150 N/mm ²	> 250	> 850	O E
	16 Aciers haute résistance ≤ 44 HRC	Acciai ad alta resistenza ≤ 44 HRC	> 250	> 850	O E
	17 Aciers améliorés > 44 - ≤ 54 HRC	Acciai bonificati > 44 - ≤ 54 HRC	> 410	> 1400	O E
	18 Aciers trempés > 54 - ≤ 63 HRC	Acciai temprati > 54 - ≤ 63 HRC	> 560	> 1980	
20 Aciers inoxydables Acciai inox	21 Aciers inoxydables, soufrés	Acciai inox, allo zolfo	< 250	< 850	O E
	22 Austénitiques	Acciai inox, austenitici	< 250	< 850	O E
	23 Ferritiques et martensitiques < 850 N/mm ²	Ferritici e martensitici < 850 N/mm ²	< 250	< 850	O E
	24 Ferritiques et martensitiques > 850 - < 1150 N/mm ²	Ferritici e martensitici > 850 - < 1150 N/mm ²	> 250	> 850	O E
30 Fonte Ghisa	31 Fonte grise	Ghisa grigia	< 250	< 850	O E
	32 Fonte à graphite sphéroïdale et malleable	Ghisa grafitica sferoidale e malleabile	< 250	< 850	O E
40 Titane Titanio	41 Titane pur	Titanio puro	< 250	< 850	O E
	42 Alliage de titane	Leghe di titanio	> 250	> 850	O E
50 Nickel Nickel	51 Alliage de nickel 1 ≤ 850 N/mm ²	Leghe di nickel 1 ≤ 850 N/mm ²	< 250	< 850	O E
	52 Alliage de nickel 2 > 850 - ≤ 1150 N/mm ²	Leghe di nickel 2 > 850 - ≤ 1150 N/mm ²	> 250	> 850	O E
	53 Alliage de nickel 3 > 1150 - ≤ 1600 N/mm ²	Leghe di nickel 3 > 1150 - ≤ 1600 N/mm ²	> 340	> 1150	O E
60 Cuivre Rame	61 Cuivre pur (électrolytique)	Rame puro (elettrolitico)	< 120	< 400	O E
	62 Laiton, bronze (copeaux courts)	Ottone, bronzo (trucioli corti)	< 200	< 700	O E
	63 Laiton (copeaux longs)	Ottone (trucioli lunghi)	< 200	< 700	O E
	64 Laiton sans plomb	Ottone senza piombo	< 220	< 700	O E
70 Aluminium Magnésium Alluminio Magnesio	71 Al non allié	Alluminio non legato	< 100	< 350	O E
	72 Al allié Si < 1.5 %	Leghe di alluminio Si < 1.5 %	< 150	< 500	O E
	73 Al allié Si > 1.5 % - < 10 %	Leghe di alluminio Si > 1.5 % - < 10 %	< 120	< 400	O E
	74 Al allié Si > 10 %, alliages de magnésium	Leghe di al. Si > 10 %, leghe di magnesio	< 120	< 400	O E
80 Matières plastiques Materie plastiche	81 Matières thermoplastiques	Materie termoplastiche	-	-	E
	82 Matières duroplastiques	Materie termoindurenti	-	-	E
	83 Matières plastiques renforcées par fibres	Materie plastiche rinforzate con fibre	-	-	E
90 Métaux précieux Metalli preziosi	91 Or jaune	Oro giallo	-	-	O E
	92 Or rose	Oro rosso	-	-	O E
	93 Or blanc	Oro bianco	-	-	O E
	94 Argent	Argento	-	-	O E

MÈCHES À CENTRER C315VS — PUNTE DA CENTRO C315VS



	Vc (m/min) Guide Line Rivestito	C315VS						
		Avance f (mm/tour)			Avanzamento f (mm/giro)			
		Ø 1.40	Ø 2.00	Ø 3.00	Ø 4.00	Ø 6.00	Ø 8.00	
11	120	0.05	0.08	0.10	0.12	0.15	0.20	11
12	120	0.05	0.08	0.10	0.12	0.15	0.20	12
13	120	0.05	0.08	0.10	0.12	0.15	0.20	13
14	80	0.05	0.08	0.10	0.12	0.15	0.20	14
15	60	0.03	0.04	0.06	0.08	0.12	0.18	15
16	40	0.02	0.03	0.04	0.05	0.06	0.07	16
17	40	0.02	0.03	0.04	0.05	0.06	0.07	17
18								18
21	60	0.03	0.04	0.06	0.08	0.12	0.18	21
22	50	0.03	0.04	0.06	0.07	0.09	0.11	22
23	50	0.03	0.04	0.06	0.07	0.09	0.11	23
24	50	0.03	0.04	0.06	0.07	0.09	0.11	24
31	100	0.04	0.05	0.07	0.09	0.11	0.15	31
32	100	0.04	0.05	0.07	0.09	0.11	0.15	32
41	25	0.03	0.04	0.06	0.07	0.09	0.11	41
42	25	0.04	0.07	0.09	0.11	0.14	0.18	42
51	25	0.025	0.03	0.04	0.05	0.07	0.09	51
52	20	0.025	0.03	0.04	0.05	0.07	0.09	52
53	10	0.025	0.03	0.04	0.05	0.07	0.09	53
61	100	0.06	0.09	0.11	0.13	0.18	0.23	61
62	100	0.06	0.09	0.11	0.13	0.16	0.18	62
63	80	0.06	0.09	0.11	0.13	0.16	0.18	63
64	80	0.06	0.09	0.11	0.13	0.16	0.18	64
71	150	0.06	0.09	0.11	0.13	0.18	0.23	71
72	150	0.06	0.09	0.11	0.13	0.18	0.23	72
73	100	0.06	0.09	0.11	0.13	0.18	0.23	73
74	100	0.06	0.09	0.11	0.13	0.18	0.23	74
81	200	0.08	0.11	0.13	0.15	0.20	0.25	81
82	200	0.08	0.11	0.13	0.15	0.20	0.25	82
83	100	0.08	0.11	0.13	0.15	0.20	0.25	83
91	200	0.08	0.11	0.13	0.15	0.20	0.25	91
92	150	0.08	0.11	0.13	0.15	0.20	0.25	92
93	100	0.08	0.11	0.13	0.15	0.20	0.25	93
94	100	0.08	0.11	0.13	0.15	0.20	0.25	94

Les valeurs ci-dessus sont indicatives.
I valori sopracitati sono indicativi.

TABELLE D'UTILISATION — TABELLA D'IMPIEGO

Cycle de programmation pour mèches FZ315VS

Ciclo di programmazione per punte elicoidali FZ315VS

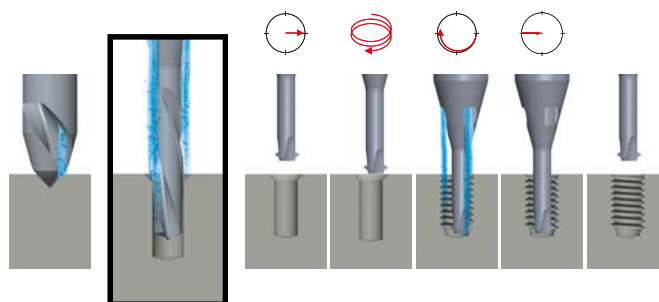

DC Classification des matières

DC Classificazione dei materiali

Groupes de matières Gruppi di materiali	Désignation des matières	Designazione dei materiali	Dureté Durezza (HB)	Résistance Resistenza Rm (N/mm ²)	Lubrifiant Lubrificante A (%)
10 Aciers Acciai	11 Aciers de décolletage	Acciai da tornitura	< 200	< 700	<input type="radio"/> O <input type="radio"/> E
	12 Aciers de construction ou de cémentation	Acciai da costruzione / da cementazione	< 200	< 700	<input type="radio"/> O <input type="radio"/> E
	13 Aciers au carbone	Acciai al carbonio	< 300	< 1000	<input type="radio"/> O <input type="radio"/> E
	14 Aciers alliés < 850 N/mm ²	Acciai legati < 850 N/mm ²	< 250	< 850	<input type="radio"/> O <input type="radio"/> E
	15 Aciers alliés / traités > 850 - < 1150 N/mm ²	Acciai legati / trattati > 850 - < 1150 N/mm ²	> 250	> 850	<input type="radio"/> O <input type="radio"/> E
	16 Aciers haute résistance ≤ 44 HRC	Acciai ad alta resistenza ≤ 44 HRC	> 250	> 850	<input type="radio"/> O <input type="radio"/> E
	17 Aciers améliorés > 44 - ≤ 54 HRC	Acciai bonificati > 44 - ≤ 54 HRC	> 410	> 1400	<input type="radio"/> O <input type="radio"/> E
	18 Aciers trempés > 54 - ≤ 63 HRC	Acciai temprati > 54 - ≤ 63 HRC	> 560	> 1980	<input type="radio"/> O <input type="radio"/> E
20 Aciers inoxydables Acciai inox	21 Aciers inoxydables, soufrés	Acciai inox, allo zolfo	< 250	< 850	<input type="radio"/> O <input type="radio"/> E
	22 Austénitiques	Acciai inox, austenitici	< 250	< 850	<input type="radio"/> O <input type="radio"/> E
	23 Ferritiques et martensitiques < 850 N/mm ²	Ferritici e martensitici < 850 N/mm ²	< 250	< 850	<input type="radio"/> O <input type="radio"/> E
	24 Ferritiques et martensitiques > 850 - < 1150 N/mm ²	Ferritici e martensitici > 850 - < 1150 N/mm ²	> 250	> 850	<input type="radio"/> O <input type="radio"/> E
30 Fonte Ghisa	31 Fonte grise	Ghisa grigia	< 250	< 850	<input type="radio"/> O <input type="radio"/> E
	32 Fonte à graphite sphéroïdale et malleable	Ghisa grafitica sferoidale e malleabile	< 250	< 850	<input type="radio"/> O <input type="radio"/> E
40 Titane Titanio	41 Titane pur	Titanio puro	< 250	< 850	<input type="radio"/> O <input type="radio"/> E
	42 Alliage de titane	Leghe di titanio	> 250	> 850	<input type="radio"/> O <input type="radio"/> E
50 Nickel Nickel	51 Alliage de nickel 1 ≤ 850 N/mm ²	Leghe di nickel 1 ≤ 850 N/mm ²	< 250	< 850	<input type="radio"/> O <input type="radio"/> E
	52 Alliage de nickel 2 > 850 - ≤ 1150 N/mm ²	Leghe di nickel 2 > 850 - ≤ 1150 N/mm ²	> 250	> 850	<input type="radio"/> O <input type="radio"/> E
	53 Alliage de nickel 3 > 1150 - ≤ 1600 N/mm ²	Leghe di nickel 3 > 1150 - ≤ 1600 N/mm ²	> 340	> 1150	<input type="radio"/> O <input type="radio"/> E
60 Cuivre Rame	61 Cuivre pur (électrolytique)	Rame puro (elettrolitico)	< 120	< 400	<input type="radio"/> O <input type="radio"/> E
	62 Laiton, bronze (copeaux courts)	Ottone, bronzo (trucioli corti)	< 200	< 700	<input type="radio"/> O <input type="radio"/> E
	63 Laiton (copeaux longs)	Ottone (trucioli lunghi)	< 200	< 700	<input type="radio"/> O <input type="radio"/> E
	64 Laiton sans plomb	Ottone senza piombo	< 220	< 700	<input type="radio"/> O <input type="radio"/> E
70 Aluminium Magnésium Alluminio Magnesio	71 Al non allié	Alluminio non legato	< 100	< 350	<input type="radio"/> O <input type="radio"/> E
	72 Al allié Si < 1.5 %	Leghe di alluminio Si < 1.5 %	< 150	< 500	<input type="radio"/> O <input type="radio"/> E
	73 Al allié Si > 1.5 % - < 10 %	Leghe di alluminio Si > 1.5 % - < 10 %	< 120	< 400	<input type="radio"/> O <input type="radio"/> E
	74 Al allié Si > 10 %, alliages de magnésium	Leghe di al. Si > 10 %, leghe di magnesio	< 120	< 400	<input type="radio"/> O <input type="radio"/> E
80 Matières plastiques Materie plastiche	81 Matières thermoplastiques	Materie termoplastiche	-	-	<input type="radio"/> E
	82 Matières duroplastiques	Materie termoindurenti	-	-	<input type="radio"/> E
	83 Matières plastiques renforcées par fibres	Materie plastiche rinforzate con fibre	-	-	<input type="radio"/> E
90 Métaux précieux Metalli preziosi	91 Or jaune	Oro giallo	-	-	<input type="radio"/> O <input type="radio"/> E
	92 Or rose	Oro rosso	-	-	<input type="radio"/> O <input type="radio"/> E
	93 Or blanc	Oro bianco	-	-	<input type="radio"/> O <input type="radio"/> E
	94 Argent	Argento	-	-	<input type="radio"/> O <input type="radio"/> E

MÈCHES FZ315VS — PUNTE ELICOIDALI FZ315VS



FZ315VS

VS	VS	VS	VS			
Vc (m/min) Guide Line Ø 0.58 - 2.0		Avance f (mm/tour)		Avanzamento f (mm/giro)		
Revêtu Rivestito	Ø0.58-0.82	Ø0.83-1.07	Ø1.08-1.46	Ø1.47-2.0	Q1	Qx

11	40 - 60	0.02-0.035	0.03-0.045	0.04-0.055	0.05-0.065	1xd,-4xd	1xd,-2xd
12	40 - 60	0.02-0.035	0.03-0.045	0.04-0.055	0.05-0.065	1xd,-4xd	1xd,-2xd
13	35 - 55	0.015-0.025	0.025-0.035	0.035-0.045	0.045-0.055	1xd,-4xd	1xd,-2xd
14	35 - 55	0.015-0.025	0.025-0.035	0.035-0.045	0.045-0.055	1xd,-4xd	1xd,-2xd
15	35 - 55	0.015-0.025	0.025-0.035	0.035-0.045	0.045-0.055	1xd,-4xd	1xd,-2xd
16	35 - 55	0.015-0.025	0.025-0.035	0.035-0.045	0.045-0.055	1xd,-4xd	1xd,-2xd
17	30 - 45	0.015-0.025	0.025-0.035	0.035-0.045	0.045-0.055	1xd,-4xd	1xd,-2xd
18							
21	30 - 45	0.015-0.025	0.025-0.035	0.035-0.045	0.045-0.055	1xd,-4xd	1xd,-2xd
22	30 - 45	0.015-0.025	0.025-0.035	0.035-0.045	0.045-0.055	1xd,-4xd	1xd,-2xd
23	35 - 50	0.02-0.025	0.025-0.035	0.04-0.05	0.05-0.065	1xd,-4xd	1xd,-2xd
24	35 - 50	0.02-0.025	0.025-0.035	0.04-0.05	0.05-0.065	1xd,-4xd	1xd,-2xd
31	50 - 80	0.025-0.045	0.045-0.065	0.065-0.085	0.085-0.10	4xd,-8xd	4xd
32	40 - 70	0.025-0.045	0.045-0.065	0.065-0.085	0.085-0.10	4xd,-8xd	4xd
41	15 - 25	0.005-0.02	0.015-0.045	0.04-0.06	0.055-0.07	1/2xd,-1xd	1/4xd,-1/2xd
42	15 - 25	0.005-0.02	0.015-0.045	0.04-0.06	0.055-0.07	1/2xd,-1xd	1/4xd,-1/2xd
51	15 - 25	0.005-0.02	0.02-0.025	0.025-0.035	0.035-0.05	1/2xd,-1xd	1/2xd
52	15 - 25	0.015-0.02	0.02-0.025	0.025-0.035	0.035-0.05	1/2xd,-1xd	1/2xd
53	15 - 25	0.005-0.01	0.01-0.02	0.02-0.03	0.03-0.04	1/2xd,-1xd	1/2xd
61	50 - 80	0.05-0.08	0.06-0.10	0.08-0.12	0.12-0.15	4xd,-8xd	4xd
62	50 - 80	0.05-0.08	0.06-0.10	0.08-0.12	0.12-0.15	4xd,-8xd	4xd
63	50 - 80	0.05-0.08	0.06-0.10	0.08-0.12	0.12-0.15	4xd,-8xd	4xd
64	50 - 80	0.05-0.08	0.06-0.10	0.08-0.12	0.12-0.15	4xd,-8xd	4xd
71	50 - 80	0.05-0.08	0.06-0.10	0.08-0.12	0.12-0.15	2xd,-3xd	3xd
72	50 - 80	0.05-0.08	0.06-0.10	0.08-0.12	0.12-0.15	2xd,-3xd	3xd
73	50 - 80	0.05-0.08	0.06-0.10	0.08-0.12	0.12-0.15	2xd,-3xd	3xd
74	50 - 80	0.05-0.08	0.06-0.10	0.08-0.12	0.12-0.15	2xd,-3xd	3xd
81	50 - 80	0.05-0.08	0.06-0.10	0.08-0.12	0.12-0.15	4xd,-8xd	4xd
82	50 - 80	0.05-0.08	0.06-0.10	0.08-0.12	0.12-0.15	4xd,-8xd	4xd
83	40 - 60	0.02-0.035	0.03-0.045	0.04-0.055	0.05-0.065	2xd,-3xd	3xd
91	50 - 80	0.02-0.035	0.03-0.045	0.04-0.055	0.05-0.065	2xd,-3xd	3xd
92	50 - 80	0.02-0.035	0.03-0.045	0.04-0.055	0.05-0.065	2xd,-3xd	3xd
93	40 - 60	0.02-0.035	0.03-0.045	0.04-0.055	0.05-0.065	2xd,-3xd	3xd
94	40 - 60	0.02-0.035	0.03-0.045	0.04-0.055	0.05-0.065	2xd,-3xd	3xd



FZ315VS

VS	VS	VS			
Vc (m/min) Guide Line Ø 2.01 - 5.4		Avance f (mm/tour)		Avanzamento f (mm/giro)	
Revêtu Rivestito	Ø2.01-3.05	Ø3.06-4.5	Ø4.51-5.4	Qx	

80 - 110	0.07-0.12	0.12-0.18	0.18-0.23		11
80 - 110	0.07-0.12	0.12-0.17	0.17-0.22		12
70 - 100	0.07-0.12	0.12-0.17	0.17-0.22		13
70 - 100	0.07-0.12	0.12-0.17	0.17-0.22		14
70 - 100	0.07-0.12	0.12-0.17	0.17-0.22		15
70 - 100	0.07-0.10	0.10-0.14	0.14-0.17		16
60 - 80	0.07-0.10	0.10-0.15	0.14-0.18		17
					18
60 - 80	0.045-0.055	0.055-0.07	0.07-0.10		21
60 - 80	0.045-0.055	0.055-0.07	0.07-0.10		22
60 - 80	0.05-0.065	0.05-0.065	0.06-0.09		23
60 - 80	0.05-0.065	0.05-0.065	0.06-0.09		24
90 - 130	0.10-0.15	0.15-0.20	0.20-0.25		31
80 - 120	0.10-0.14	0.14-0.18	0.18-0.23		32
30 - 40	0.055-0.07	0.055-0.07	0.055-0.07	1/3xd,-1/2xd	41
30 - 40	0.055-0.07	0.055-0.07	0.055-0.07	1/3xd,-1/2xd	42
30 - 40	0.035-0.05	0.035-0.05	0.05-0.08		51
30 - 40	0.035-0.05	0.035-0.05	0.05-0.08		52
30 - 40	0.03-0.04	0.03-0.04	0.04-0.06		53
130 - 180	0.12-0.15	0.15-0.20	0.20-0.25		61
130 - 180	0.12-0.15	0.15-0.20	0.20-0.25		62
80 - 110	0.12-0.15	0.14-0.18	0.18-0.23		63
80 - 110	0.12-0.15	0.14-0.18	0.18-0.23		64
130 - 180	0.12-0.15	0.15-0.20	0.20-0.25		71
130 - 180	0.12-0.15	0.15-0.20	0.20-0.25		72
100 - 130	0.12-0.15	0.14-0.18	0.18-0.23		73
100 - 130	0.12-0.15	0.14-0.18	0.18-0.23		74
130 - 180	0.12-0.15	0.15-0.20	0.20-0.25		81
130 - 180	0.12-0.15	0.15-0.20	0.20-0.25		82
80 - 120	0.07-0.12	0.12-0.18	0.18-0.23		83
130 - 180	0.07-0.12	0.12-0.17	0.17-0.22		91
130 - 180	0.07-0.12	0.12-0.17	0.17-0.22		92
80 - 110	0.07-0.12	0.12-0.17	0.17-0.22		93
80 - 110	0.07-0.12	0.12-0.17	0.17-0.22		94

Les valeurs ci-dessus sont indicatives.
I valori sopracitati sono indicativi.



TABELLE D'UTILISATION — TABELLA D'IMPIEGO

DC Classification des matières

DC Classificazione dei materiali

Groupes de matières Gruppi di materiali	Désignation des matières	Designazione dei materiali	Dureté Durezza (HB)	Résistance Resistenza Rm (N/mm ²)	Lubrifiant Lubrificante A (%)
10 Aciers Acciai	11 Aciers de décolletage	Acciai da tornitura	< 200	< 700	
	12 Aciers de construction ou de cémentation	Acciai da costruzione / da cementazione	< 200	< 700	
	13 Aciers au carbone	Acciai al carbonio	< 300	< 1000	
	14 Aciers alliés < 850 N/mm ²	Acciai legati < 850 N/mm ²	< 250	< 850	
	15 Aciers alliés / traités > 850 - < 1150 N/mm ²	Acciai legati / trattati > 850 - < 1150 N/mm ²	> 250	> 850	
	16 Aciers haute résistance ≤ 44 HRC	Acciai ad alta resistenza ≤ 44 HRC	> 250	> 850	
	17 Aciers améliorés > 44 - ≤ 54 HRC	Acciai bonificati > 44 - ≤ 54 HRC	> 410	> 1400	
	18 Aciers trempés > 54 - ≤ 63 HRC	Acciai temprati > 54 - ≤ 63 HRC	> 560	> 1980	
20 Aciers inoxydables Acciai inox	21 Aciers inoxydables, soufrés	Acciai inox, allo zolfo	< 250	< 850	
	22 Austénitiques	Acciai inox, austenitici	< 250	< 850	
	23 Ferritiques et martensitiques < 850 N/mm ²	Ferritici e martensitici < 850 N/mm ²	< 250	< 850	
	24 Ferritiques et martensitiques > 850 - < 1150 N/mm ²	Ferritici e martensitici > 850 - < 1150 N/mm ²	> 250	> 850	
30 Fonte Ghisa	31 Fonte grise	Ghisa grigia	< 250	< 850	
	32 Fonte à graphite sphéroïdale et malléable	Ghisa grafitica sferoidale e malleabile	< 250	< 850	
40 Titane Titanio	41 Titane pur	Titanio puro	< 250	< 850	
	42 Alliage de titane	Leghe di titanio	> 250	> 850	
50 Nickel Nickel	51 Alliage de nickel 1 ≤ 850 N/mm ²	Leghe di nickel 1 ≤ 850 N/mm ²	< 250	< 850	
	52 Alliage de nickel 2 > 850 - ≤ 1150 N/mm ²	Leghe di nickel 2 > 850 - ≤ 1150 N/mm ²	> 250	> 850	
	53 Alliage de nickel 3 > 1150 - ≤ 1600 N/mm ²	Leghe di nickel 3 > 1150 - ≤ 1600 N/mm ²	> 340	> 1150	
60 Cuivre Rame	61 Cuivre pur (électrolytique)	Rame puro (elettrolitico)	< 120	< 400	
	62 Laiton, bronze (copeaux courts)	Ottone, bronzo (trucioli corti)	< 200	< 700	
	63 Laiton (copeaux longs)	Ottone (trucioli lunghi)	< 200	< 700	
	64 Laiton sans plomb	Ottone senza piombo	< 220	< 700	
70 Aluminium Magnésium Alluminio Magnesio	71 Al non allié	Alluminio non legato	< 100	< 350	
	72 Al allié Si < 1.5 %	Leghe di alluminio Si < 1.5 %	< 150	< 500	
	73 Al allié Si > 1.5 % - < 10 %	Leghe di alluminio Si > 1.5 % - < 10 %	< 120	< 400	
	74 Al allié Si > 10 %, alliages de magnésium	Leghe di al. Si > 10 %, leghe di magnesio	< 120	< 400	
80 Matières plastiques Materie plastiche	81 Matières thermoplastiques	Materie termoplastiche	-	-	
	82 Matières duroplastiques	Materie termoindurenti	-	-	
	83 Matières plastiques renforcées par fibres	Materie plastiche rinforzate con fibre	-	-	
90 Métaux précieux Metalli preziosi	91 Or jaune	Oro giallo	-	-	
	92 Or rose	Oro rosso	-	-	
	93 Or blanc	Oro bianco	-	-	
	94 Argent	Argento	-	-	

MÈCHES F286VS — PUNTE ELICOIDALI F286VS

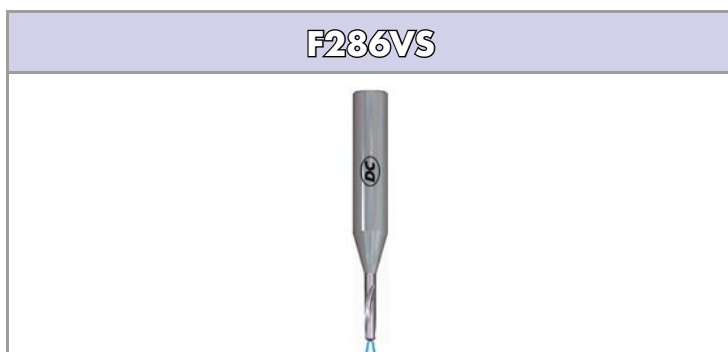

		F286VS							
		VS	VS	VS	VS	VS	VS		
		Avance f (mm/tour)			Avanzamento f (mm/giro)				
		Ø 0.8 - 1.2	Ø 1.21 - 3.0	Ø 3.01 - 6.0	Ø 6.01 - 8.5	Ø 8.51 - 11.0	Ø 11.02 - 14.0		
Vc (m/min) Guide Line Revêtu Rivestito									
11	70 - 90	0.015-0.025	0.015-0.025	0.035-0.045	0.11-0.13	0.15-0.17	0.18-0.22	11	
12	70 - 90	0.10-0.20	0.015-0.025	0.035-0.045	0.11-0.13	0.15-0.17	0.18-0.22	12	
13	70 - 90	0.10-0.20	0.015-0.025	0.035-0.045	0.11-0.13	0.15-0.17	0.18-0.22	13	
14	70 - 90	0.10-0.20	0.015-0.025	0.035-0.045	0.11-0.13	0.15-0.17	0.18-0.22	14	
15	60 - 80	0.10-0.20	0.015-0.025	0.035-0.045	0.07-0.09	0.11-0.13	0.15-0.17	15	
16								16	
17								17	
18								18	
21	40 - 60	0.008-0.012	0.015-0.02	0.035-0.04	0.075-0.085	0.095-0.105	0.15-0.16	21	
22	40 - 60	0.008-0.012	0.015-0.02	0.035-0.04	0.075-0.085	0.095-0.105	0.15-0.16	22	
23	40 - 60	0.008-0.012	0.015-0.02	0.035-0.04	0.075-0.085	0.095-0.105	0.15-0.16	23	
24	40 - 60	0.008-0.012	0.015-0.02	0.035-0.04	0.075-0.085	0.095-0.105	0.15-0.16	24	
31								31	
32								32	
41	40 - 80	0.003-0.006	0.008-0.012	0.01-0.018	0.025-0.03	0.055-0.06	0.075-0.085	41	
42								42	
51	30 - 50	0.008-0.012	0.015-0.02	0.035-0.04	0.075-0.085	0.095-0.105	0.11-0.13	51	
52								52	
53								53	
61	70 - 150	0.15-0.25	0.035-0.045	0.055-0.065	0.11-0.13	0.15-0.17	0.18-0.22	61	
62								62	
63	70 - 150	0.15-0.25	0.035-0.045	0.055-0.065	0.11-0.13	0.15-0.17	0.18-0.22	63	
64	70 - 150	0.15-0.25	0.035-0.045	0.055-0.065	0.11-0.13	0.15-0.17	0.18-0.22	64	
71	100 - 160	0.025-0.035	0.045-0.055	0.075-0.085	0.15-0.17	0.22-0.26	0.30-0.34	71	
72	100 - 160	0.025-0.035	0.045-0.055	0.075-0.085	0.15-0.17	0.22-0.26	0.30-0.34	72	
73	60 - 130	0.02-0.03	0.035-0.045	0.055-0.065	0.11-0.13	0.16-0.20	0.22-0.26	73	
74								74	
81								81	
82								82	
83								83	
91								91	
92								92	
93	40 - 60	0.008-0.012	0.015-0.02	0.035-0.04	0.075-0.085	0.095-0.105	0.15-0.16	93	
94	40 - 60	0.008-0.012	0.015-0.02	0.035-0.04	0.075-0.085	0.095-0.105	0.15-0.16	94	

Les valeurs ci-dessus sont indicatives.
I valori sopracitati sono indicativi.



Mèches à centrer en carbure monobloc
Punte da centro in metallo duro integrale

VHM
CAR

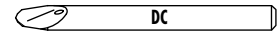

h6

C

C315VS

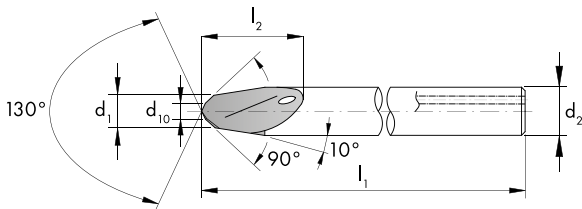
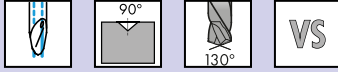

C315VS



$\emptyset d_1$	l_1 mm	l_2 mm	d_2 h6 mm	d_{10} mm	
1.4	40	6	3	0.5	2
2	40	6.2	3	1	2
3	40	6.3	3	1.5	2
4	50	8	4	2	2
6	60	12	6	3	2
8	70	16	8	4	2

ID

- 182872
- 182873
- 182874
- 190331
- 190332
- 190333

Mèches en carbure monobloc
Punte elicoidali in metallo duro integrale

VHM
CAR

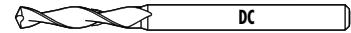

h6

FZ

FZ315VS

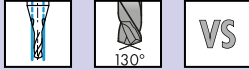

FZ315VS

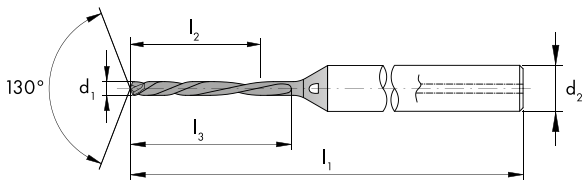

FZ315VS

FZ315VS



$\emptyset d_1$	D_1 mm	l_1 mm	l_2 mm	l_3 mm	d_2 h6 mm		ID
0.58	M0.8	42	4.6	5.7	3	2	● 182863
0.59	S0.8	42	4.7	5.8	3	2	● 188023
0.65	M0.9	45	5.2	6.4	3	2	● 182864
0.67	S0.9	45	5.4	6.6	3	2	● 188024
0.7	M1	45	5.6	6.9	3	2	● 182865
0.74	S1	45	5.9	7.3	3	2	● 188025
0.9	M1.2	45	7.2	8.8	3	2	● 182866
0.94	S1.2	48	7.5	9.2	3	2	● 188026
1.05	M1.4	48	8.4	10.3	3	2	● 182867
1.09	S1.4	48	8.7	10.7	3	2	● 188027
1.19	M1.6	48	9.5	11.7	3	2	● 182868
1.39	M1.8	52	11.1	13.6	4	2	● 182869
1.54	M2	55	12.3	15.1	4	2	● 182870
1.98	M2.5	55	15.8	19.4	4	2	● 182871
$\emptyset d_1$	D_1 mm	l_1 mm	l_2 mm	l_3 mm	d_2 h6 mm		ID
2.15	UNC4	63	12.9	19.4	4	2	● 190326
2.45	M3	65	14.7	22.1	4	2	● 190321
2.65	UNC6	68	15.9	23.9	4	2	● 190327
2.85	M3.5	68	17.1	25.7	4	2	● 190322
3.25	M4	74	19.5	29.3	6	2	● 190323
3.95	UNF10	78	23.7	35.6	6	2	● 190329
4.1	M5	80	24.6	36.9	6	2	● 190324
4.9	M6	84	29.4	44.1	6	2	● 190325
5	UNC1/4	84	30	45	6	2	● 190328
5.4	UNF1/4	88	32.4	48.6	6	2	● 190330

Mèches en carbure monobloc
Punte elicoidali in metallo duro integrale

VHM
CAR

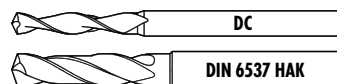

HBK
HEK

sur demande
auf Anfrage
on request
su richiesta
sobre pedido
no zakazy



						F313VS	F285VS	F286VS		
<p>F313VS</p> <p>11 12 13 14 15 21 22 23 24 41 61 63 71 72 73 74</p>										
<p>F285VS F286VS</p> <p>11 12 13 14 15 21 22 23 24 41 51 61 71 72 73 74 93 94</p>										
$\emptyset d_1$ (h ₇)	d_2 (h ₆) mm	l_1 mm	l_2 mm			ID				
0.88	3	38	8	2	M1	● 158515				
0.9	3	38	10	2	*M1.2	● 159419				
1.08	3	38	10	2	M1.2	● 158516				
1.25	3	38	12	2	M1.4	● 158517				
1.45	3	38	12	2	M1.6	● 158518				
1.65	3	38	12	2	M1.8	● 158519				
1.8	3	38	12	2	M2	● 158520				
1.95	3	38	12	2	UNC2-56	● 158521				
2.3	3	38	16	2	M2.5	● 158522				
2.55	3	38	16	2	UNC4-40	● 158523				
2.8	3	38	16	2	M3	● 158524				
*GWi5000										
$\emptyset d_1$ (m ₇)	d_2 (h ₆) mm	l_1 mm	l_2 mm	l_3 mm			ID			
3.25	6	62	20	14	2	M3.5	● 158527			
3.7	6	62	20	14	2	M4	● 158528			
4.65	6	66	24	17	2	M5	● 158532			
5.55	6	66	28	20	2	M6	● 158534			
7.4	8	79	41	29	2	M8	● 158540			
9.3	10	89	47	35	2	M10	● 158544			
11.2	12	102	55	40	2	M12	● 158546			
$\emptyset d_1$ (m ₇)	d_2 (h ₆) mm	l_1 mm	l_2 mm	l_3 mm			ID			
3.3	6	66	28	23	2	M4	● 160989			
4.2	6	74	36	29	2	M5	● 160990			
5	6	82	44	35	2	M6	● 160991			
6.8	8	91	53	43	2	M8	● 160992			
8.5	10	103	61	49	2	M10	● 160993			
10.2	12	118	71	56	2	M12	● 160994			

A large, detailed image of a metal drill bit with a complex, multi-fluted 'Z-challenging' threading design. The drill bit is oriented vertically, with its tip pointing downwards. The background is a dynamic, high-contrast image of turbulent blue water with white foam, suggesting a challenging environment. The text 'Z | CHALLENGING THREADING' is overlaid on the lower part of the image.



**Z | CHALLENGING
THREADING**



Porte-filières et tourne-à-gauche Porta-filiera e giramaschi

<p>D5810- Porte-filière pour filières rondes, selon normes DIN EN 22568, DIN EN 24230, DIN EN 24231, DIN EN 40434 Porta-filiera per filiera tonda, DIN EN 22568, DIN EN 24230, DIN EN 24231, DIN EN 40434</p> <p>D5820- Tourne-à-gauche réglable DIN 1814 Giramaschi regolabili DIN 1814</p>										D5810-	D5820-
											
DIN EN	M	MF	UNC	UNF	UNEF UNS UN	W	G (BSP)	NPT NPTF R (BSPT)	ID		
No D5810- Ø	Ø	Ø	Ø	Ø	Ø	Ø	Ø	Ø			
1 16 x 5	1 - 2.6	2 - 2.6	No. 1 - 4	No. 1 - 4		1/16" - 3/32"			● 170712		
2 20 x 5	3 - 4	3 - 6	No 5	No 5 - 6		1/8"			● 170713		
3 20 x 7	4.5 - 6		No 6 - 1/4"	No 8 - 1/4"	No 12 - 1/4"	5/32" - 1/4"			● 170714		
4 25 x 9	7 - 9	7 - 9	5/16"	5/16"	5/16"	5/16"		1/16"	● 170715		
5 30 x 11	10 - 11	10 - 11	3/8" - 7/16"	3/8" - 7/16"	3/8" - 7/16"	3/8" - 7/16"	1/8"	1/8"	● 170716		
6 38 x 10		12 - 15		1/2" - 9/16"	1/2" - 9/16"		1/4"		● 170717		
7 38 x 14	12 - 14		1/2" - 9/16"			1/2" - 9/16"		1/4"	● 170718		
8 45 x 14		16 - 20		5/8" - 3/4"	5/8" - 13/16"		3/8" - 1/2"	3/8"	● 170719		
9 45 x 18	16 - 20		5/8" - 3/4"			5/8" - 3/4"		1/2"	● 170720		
10 55 x 22		22 - 26		7/8" - 1"	7/8" - 1"		5/8" - 3/4"		● 170721		
11 55 x 26	22 - 24		7/8" - 1"			7/8" - 1"		3/4"	● 170722		
12 65 x 18		*27 - 36		1 1/8" - 1 3/8"	1 1/16" - 1 3/8"		7/8" - 1"		● 170723		
13 65 x 25	27 - 36		1 1/8" - 1 3/8"			1 1/8" - 1 3/8"		1"	● 170724		
14 75 x 20		38 - 42		1 1/2"	1 7/16" - 1 1/2"		1 1/8" - 1 1/4"		● 170725		
15 75 x 30	39 - 42		1 1/2"			1 1/2" - 1 5/8"			● 170726		
16 90 x 22		45 - 52			1 3/4" - 2"		1 3/8" - 1 3/4"		● 170727		
17 90 x 36	45 - 52		1 3/4" - 2"			1 3/4" - 2"			● 170728		
18 105 x 22		55 - 65					2" - 2 1/4"		● 170729		
<p>*Utiliser le No 13 pour le pas de 3 mm. Per passo 3 mm utilizzare N.13.</p>											
No D5820-	a mm									ID	
0	1.9 - 3									● 170730	
1	2.5 - 5.5									● 170731	
2	4.3 - 8									● 170732	
3	5.5 - 12									● 170733	
4	9.5 - 15.5									● 170734	
5	12.5 - 22.4									● 170735	

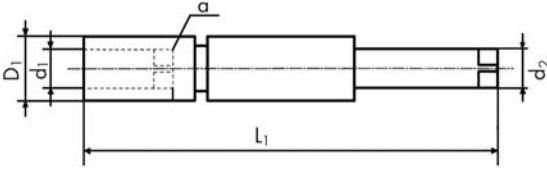
Rallonges pour tarauds Prolunghe per maschi

D5830- Rallonge pour taraud, ~DIN 377 Prolunghe per maschi, ~DIN 377		D5840- Rallonge pour taraud Prolunghe per maschi				D5830-	D5840-
							
No	a	L ₁				ID	
D5830-	mm	mm					
D ₁							
mm							
1	2.1	60				6	● 110571
2	2.24	70				6	● 110572
3	2.4	70				6	● 110573
4	2.5	80				7	● 110574
5	2.8	90				7	● 110575
6	3	90				7	● 110579
7	3.15	95				7	● 110580
8	3.4	95				8	● 110581
9	3.55	100				8	● 118706
10	3.8	100				9	● 118707
11	4	105				10	● 118708
12	4.3	105				10	● 118709
13	4.5	105				10	● 118710
14	4.9	110				10	● 118711
15	5	110				11	● 118712
16	5.5	115				12	● 118713
17	5.6	110				12	● 118714
18	6.2	120				14	● 118715
19	6.3	120				14	● 118716
20	7	125				15	● 118717
21	7.1	120				15	● 118718
22	7.5	120				15	● 118719
23	8	125				17	● 118720
24	9	130				19	● 118721
25	10	140				21	● 110562
26	11	150				23	● 110563
27	11.2	145				23	● 110564
28	12	155				25	● 110565
29	12.5	160				25	● 110566
30	14	165				28	● 110567
31	14.5	175				29	● 110568
32	16	180				30	● 110569
33	18	200				33	● 110570
34	20	220				36	● 110576
35	22	220				40	● 110577
36	22.4	240				40	● 110578
No	a	L ₁	d ₂	d ₁	D ₁	ID	
D5840-	mm	mm	mm	mm	mm		
10	2.7	130	6	3.5	7.5		● 169928
11	3.4	130	6	4.5	8.5		● 169929
1	4.9	130	6	6	12		● 142137
2	5.5	130	7	7	13		● 142138
3	6.2	130	8	8	13		● 142139
4	7	130	9	9	17		● 142140
5	8	130	10	10	17		● 142141
6	9	130	11	11	17		● 142142
7	9	130	12	12	20		● 142143
8	11	130	14	14	20		● 142144
9	12	130	16	16	25		● 142145



MAITRISEZ L'INFINIMENT PETIT ET LES PLUS HAUTES PRÉCISIONS DANS LES LIAISONS VISSÉES

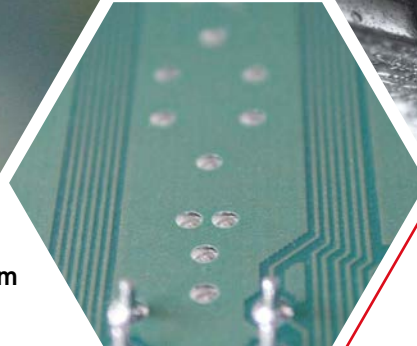
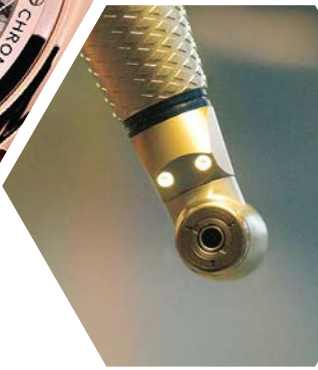
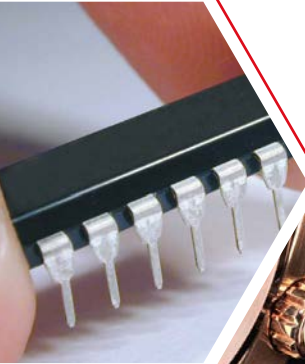

nano

PADRONEGGIARE LE PIÙ PICCOLE E PRECISE CONNESSIONI FILETTATE



DES OUTILS SPÉCIAUX SUR MESURE

Certains processus nécessitent des outils spécifiques réalisés sur mesure. DC SWISS a la possibilité de réaliser votre outil de filetage selon vos besoins.

Avec notre savoir-faire, nous réalisons des outils sur mesure répondant aux très hautes exigences du marché.

Afin de vous permettre de réaliser les assemblages les plus complexes, les plus divers et les mieux adaptés à chaque situation, DC SWISS met à votre disposition ses compétences et sa grande expérience. Il saura s'adapter à chaque configuration, à chaque matière et à toutes les techniques de production. Les formes et les dimensions ne sont plus des contraintes, DC SWISS les développe naturellement car les fabrications spéciales deviennent la nouvelle tendance.

MÉDICAL
SETTORE MEDICALE

AÉROSPATIALE
SETTORE AEROSPAZIALE

SOLUTIONS PERSONNALISÉES
SOLUZIONI PERSONALIZZATE



STRUMENTI SPECIALI SU RICHIESTA

Alcuni processi richiedono strumenti speciali su richiesta. DC SWISS è in grado di creare utensili a filettare su misura per soddisfare le vostre esigenze.

Con la nostra esperienza, siamo in grado di realizzare utensili su richiesta che soddisfano i requisiti più elevati.

Per consentirvi di creare gli assemblaggi più complicati e variegati che meglio si adattano ad ogni situazione, DC SWISS vi offre l'accesso alla sua vasta esperienza. Egli devono adattarsi ad ogni configurazione, ad ogni materiale e a tutte le tecniche di produzione. Forme e dimensioni non sono più fattori limitanti. DC SWISS è abituata a sviluppare gli utensili in modo naturale, perché gli ordini su misura diventano sempre più comuni.

AUTOMOBILE
SETTORE AUTOMOBILISTICO



HORLOGERIE
INDUSTRIA DELL'OROLOGERIA



SPÉCIFICATIONS — SPECIFICHE

TAN



TAZ



FA



- Matière première en HSSE-PM de première qualité
- Précision et répétabilité de l'outil par une fabrication en un seul serrage
- Nettoyage, brossage ou polissage de 100% des outils
- Revêtement optimal adapté à chaque géométrie

- Materia prima in HSSE-PM di qualità superiore
- Precisione e ripetibilità dell'utensile mediante la produzione in un unica presa pezzo
- Pulizia, spazzolatura o lucidatura del 100 % degli utensili
- Rivestimento ottimale adattato ad ogni geometria

TAN40



- Pour trous traversants < 2 x D

- Per fori passanti < 2 x D

TAN50



- Pour trous borgnes < 2 x D

- Per fori ciechi < 2 x D

Application

Pour les matériaux faciles à usiner, les aciers, le laiton, l'or jaune, l'argent

Applicazione

Per materiali facili da lavorare, acciai, ottone, oro giallo, argento

TAN40VS



- Revêtement anti-usure "VS" polyvalent pour une longue durée de vie en production de série

- Versatile rivestimento antiusura "VS" per una lunga durata nella produzione in serie

TAN50VS



TAZ40VS



- Pour trous traversants < 2 x D
- Avec une entrée longue adaptée au pas, pour une meilleure pénétration dans la matière

- Per fori passanti < 2 x D
- Con un imbocco lungo adattato al passo, per una migliore penetrazione nel materiale

TAZ50VS



- Pour trous borgnes < 2 x D

- Per fori ciechi < 2 x D

Application

Pour matières tenaces comme des alliages de nickel, alliages de titane, matières précieuses alliées

Applicazione

Per materiali tenaci come leghe di nickel, leghe di titanio, materiali preziosi legati

- Revêtement "VS" spécifique de dernière génération adapté à la géométrie de l'outil

- Rivestimento specifico "VS" di ultima generazione adattato alla geometria dell'utensile



SPÉCIFICATIONS — SPECIFICHE

FA80VS



- Pour trous traversants et borgnes $< 2.5 \times D$
- Avec une entrée extra-courte $1.5 \times P$ (pour filet proche du fond de trou)

- Per fori passanti e ciechi $< 2.5 \times D$
- Con un imbocco extra-corto $1.5 \times P$ (per filettature vicino al fondo del foro)

FA83VS



- Pour trous traversants et borgnes $< 2.5 \times D$
- Avec entrée courte $2.5 \times P$

- Per fori passanti e ciechi $< 2.5 \times D$
- Con imbocco corto $2.5 \times P$

Application

- Pour tout type de matière avec un allongement $> 5\%$
- Polygone formé de 4 lobes dès $\varnothing 0.5 \text{ mm}$
- Résistance à la traction du filetage améliorée

Applicazione

- Per qualsiasi tipo di materiale con un allungamento $> 5\%$
- Poligono a 4 lobi da $\varnothing 0.5 \text{ mm}$
- Miglioramento della resistenza alla trazione del filetto



- Revêtement anti-usure "VS" polyvalent pour une longue durée de vie en production de série

- Versatile rivestimento antiusura "VS" per una lunga durata nella produzione in serie

SPÉCIFICATIONS — SPECIFICHE

CMS



CFA



- Nuance de métal dur adapté pour sa dureté et sa résistance à la torsion
- Précision et répétabilité du produit par une fabrication en un seul serrage
- Qualité de surface inégalée

- Grado di metallo duro idoneo per la sua durezza e resistenza alla torsione
- Precisione e ripetibilità dell'utensile mediante la produzione in un'unica presa pezzo
- Qualità di superficie insuperabile

CMS50



CMS50VS



- Pour trous traversants et borgnes $< 3 \times D$
- Avec une géométrie de l'entrée révolutionnaire pour une pénétration optimale dans la matière

- Per fori passanti e ciechi $< 3 \times D$
- Con una rivoluzionaria geometria dell'imbocco per una penetrazione ottimale del materiale

Application

- Pour matières à copeaux cassants, laiton à copeaux courts, fonte grise, Cube2, alliage d'aluminium avec Si $> 5\%$

Applicazione

- Per materiali fragili, ottone (trucioli corti), ghisa grigia, Cube2, lega di alluminio con Si $> 5\%$



- Revêtement "VS" spécifique de dernière génération adapté à la géométrie de l'outil

- Rivestimento specifico "VS" di ultima generazione adattato alla geometria dell'utensile

CFA80VS



- Pour trous traversants et borgnes $< 2.5 \times D$
- Avec une entrée extra-courte $1.5 \times P$ (pour filet proche du fond de trou)

- Per fori passanti e ciechi $< 2.5 \times D$
- Con un imbocco extra-corto $1.5 \times P$ (per filettature vicino al fondo del foro)

CFA83VS



- Pour trous traversants et borgnes $< 2.5 \times D$
- Avec entrée courte $2.5 \times P$

- Per fori passanti e ciechi $< 2.5 \times D$
- Con imbocco corto $2.5 \times P$

Application

- Pour tout type de matériaux non-ferreux avec un allongement $> 3\%$
- Pour matières telles que : alliages d'aluminium et de cuivre, or jaune et rouge, argent, etc.

Applicazione

- Per qualsiasi tipo di materiale non ferroso con un allungamento $> 3\%$
- Per materiali come: leghe di alluminio e rame, oro giallo e rosso, argento, ecc.



- Revêtement anti-usure "VS" polyvalent pour une longue durée de vie en production de série

- Versatile rivestimento antiusura "VS" per una lunga durata nella produzione in serie

CODIFICATION – CODIFICAZIONE

DC Tarauds à machine nano

DC Maschi a macchina nano

Exemple - Esempio

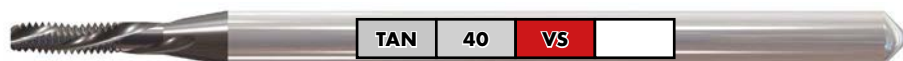

Matières normales	Materiali normali	TAN			
Matières tenaces	Materiali tenaci	TAZ			
Laitons	Ottone	CMS			
Goujures hélicoïdales < 27° à gauche	Scanalature elicoidali < 27° a sinistra		40		
Goujures hélicoïdales < 27° à droite	Scanalature elicoidali < 27° a destra		50		
Protection "VS" pour utilisation générale	Protezione antiusura "VS" per uso generale			VS	
Exécution spéciale	Esecuzione speciale				SP

Dimensions générales selon normes d'usine DC

Dimensioni di costruzione secondo gli standard di fabbrica DC

Pour application selon table de utilisation DC pour tarauds à machine DC nano

Per l'applicazione secondo la tabella d'impiego DC per le maschi a macchina DC nano

DC Tarauds à refouler nano

DC Maschi a rullare nano

Exemple - Esempio

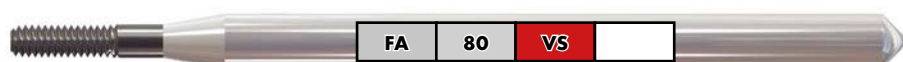

Tarauds à refouler nano en PM	Maschi a rullare nano in PM	FA			
Tarauds à refouler nano en carbure monobloc	Maschi a rullare nano in metallo duro integrale	CFA			
Entrée forme E (1.5 - 2 filets)	Imbocco forma E (1.5 - 2 filetti)		80		
Entrée forme C (2 - 3 filets)	Imbocco forma C (2 - 3 filetti)		83		
Protection "VS" pour utilisation générale	Protezione antiusura "VS" per uso generale			VS	
Exécution spéciale	Esecuzione speciale				SP

Dimensions générales selon normes d'usine DC

Dimensioni di costruzione secondo gli standard di fabbrica DC

Pour application selon table de utilisation DC pour tarauds à refouler DC nano

Per l'applicazione secondo la tabella d'impiego DC per le maschi a rullare DC nano

PICTOGRAMMES NANO – SIMBOLI NANO



Pour groupes matières selon table de utilisation
 Per gruppi di materiali secondo tabella d'impiego

12	
1.0037	Si37-2 (S235JR)
1.0050	Si50-2 (E295)
1.0060	Si60-2 (E335)
1.5919	15CrNi6
1.7131	16MnCr5

22	
1.4301	X5CrNi18-10
1.4406	X2CrNiMoN17-12-2
1.4435	X2CrNiMo18-14-3
1.4541	X6CrNiTi18-10
1.4571	X6CrNiMoTi17-12-2



Queue renforcée selon DIN 371
 Gambo rinforzato, secondo DIN 371

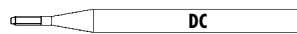

Queue renforcée selon norme DC
 Gambo rinforzato, secondo norma DC



HSSE-PM
 HSSE-PM



Carbure monobloc
 Metallo duro integrale



Nombre de lèvres (Z)
 Numero delle scanalature (Z)



Goujures hélicoïdales, hélice à 20° à gauche
 Scanalature elicoidali con elica 20° a sinistra



Goujures hélicoïdales, hélice à 25° à droite
 Scanalature elicoidali con elica 25° a destra



Tarauls à refouler
 Maschi a rullare



Trou traversant < 2 x D, copeaux longs
 Foro passante < 2 x D, trucioli lunghi



Trou borgne < 2 x D, copeaux longs
 Foro cieco < 2 x D, trucioli lunghi



Trou traversant / borgne < 2.5 x D, copeaux courts
 Foro passante / cieco < 2.5 x D, trucioli corti



Trou traversant / borgne < 3 x D, copeaux courts
 Foro passante / cieco < 3 x D, trucioli corti



2 - 3 filets d'entrée, forme C
 2 - 3 filetti d'imbocco, forma C



3.5 - 5 filets d'entrée, forme D
 3.5 - 5 filetti d'imbocco, forma D



1.5 - 2 filets d'entrée, forme E
 1.5 - 2 filetti d'imbocco, forma E



Classe de tolérance 4H
 Classe di tolleranza 4H



Classe de tolérance ISO 2 6H
 Classe di tolleranza ISO 2 6H



Protection contre l'usure "VS" pour utilisation générale
 Protezione antiusura "VS" per uso generale



Protection "VX" pour aciers inoxydables et alliages de nickel
 Protezione antiusura "VX" per acciai inossidabili e leghe di nickel

- Article en stock
 Articoli in stock
- Disponible à court terme
 Disponibile a breve
- * Disponible jusqu'à épuisement du stock
 Articoli disponibili sino ad esaurimento

TARAUDS À MACHINE NANO
MASCHI A MACCHINA NANO

DC Classification des matières

DC Classificazione dei materiali

Groupes de matières Gruppi di materiali	Désignation des matières	Designazione dei materiali	Dureté Durezza (HB)	Résistance Resistenza Rm (N/mm ²)	Allongement Allungamento A (%)
10 Aciers Acciai	11 Aciers de décolletage	Acciai da tornitura	< 200	< 700	< 10
	12 Aciers de construction ou de cémentation	Acciai da costruzione / da cementazione	< 200	< 700	< 30
	13 Aciers au carbone	Acciai al carbonio	< 300	< 1000	< 20
	14 Aciers alliés < 850 N/mm ²	Acciai legati < 850 N/mm ²	< 250	< 850	< 30
	15 Aciers alliés / traités > 850 - < 1150 N/mm ²	Acciai legati / trattati > 850 - < 1150 N/mm ²	> 250	> 850	< 30
	16 Aciers haute résistance ≤ 44 HRC	Acciai ad alta resistenza ≤ 44 HRC	> 250	> 850	< 12
	17 Aciers améliorés > 44 - ≤ 54 HRC	Acciai bonificati > 44 - ≤ 54 HRC	> 410	> 1400	< 2
	18 Aciers trempés > 54 - ≤ 63 HRC	Acciai temprati > 54 - ≤ 63 HRC	> 560	> 1980	< 2
20 Aciers inoxydables Acciai inox	21 Aciers inoxydables, soufrés	Acciai inox, allo zolfo	< 250	< 850	< 25
	22 Austénitiques	Acciai inox, austenitici	< 250	< 850	> 20
	23 Ferritiques et martensitiques < 850 N/mm ²	Ferritici e martensitici < 850 N/mm ²	< 250	< 850	> 20
	24 Ferritiques et martensitiques > 850 - < 1150 N/mm ²	Ferritici e martensitici > 850 - < 1150 N/mm ²	> 250	> 850	> 15
30 Fonte Ghisa	31 Fonte grise	Ghisa grigia	< 250	< 850	< 10
	32 Fonte à graphite sphéroïdale et malléable	Ghisa grafitica sferoidale e malleabile	< 250	< 850	> 10
40 Titane Titanio	41 Titane pur	Titanio puro	< 250	< 850	> 20
	42 Alliage de titane	Leghe di titanio	> 250	> 850	< 20
50 Nickel Nickel	51 Alliage de nickel 1 ≤ 850 N/mm ²	Leghe di nickel 1 ≤ 850 N/mm ²	< 250	< 850	> 25
	52 Alliage de nickel 2 > 850 - ≤ 1150 N/mm ²	Leghe di nickel 2 > 850 - ≤ 1150 N/mm ²	> 250	> 850	< 25
	53 Alliage de nickel 3 > 1150 - ≤ 1600 N/mm ²	Leghe di nickel 3 > 1150 - ≤ 1600 N/mm ²	> 340	> 1150	< 20
60 Cuivre Rame	61 Cuivre pur (électrolytique)	Rame puro (elettrolitico)	< 120	< 400	> 12
	62 Laiton, bronze (copeaux courts)	Ottone, bronzo (trucioli corti)	< 200	< 700	< 12
	63 Laiton (copeaux longs)	Ottone (trucioli lunghi)	< 200	< 700	> 12
	64 Laiton sans plomb	Ottone senza piombo	< 220	< 700	> 15
70 Aluminium Magnésium Alluminio Magnesio	71 Al non allié	Alluminio non legato	< 100	< 350	> 15
	72 Al allié Si < 1.5 %	Leghe di alluminio Si < 1.5 %	< 150	< 500	> 15
	73 Al allié Si > 1.5 % - < 10 %	Leghe di alluminio Si > 1.5 % - < 10 %	< 120	< 400	< 15
	74 Al allié Si > 10 %, alliages de magnésium	Leghe di al. Si > 10 %, leghe di magnesio	< 120	< 400	< 10
80 Matières plastiques Materie plastiche	81 Matières thermoplastiques	Materie termoplastiche	-	-	-
	82 Matières duroplastiques	Materie termoindurenti	-	-	-
	83 Matières plastiques renforcées par fibres	Materie plastiche rinforzate con fibre	-	-	-
90 Métaux précieux Metalli preziosi	91 Or jaune	Oro giallo	-	-	-
	92 Or rose	Oro rosso	-	-	-
	93 Or blanc	Oro bianco	-	-	-
	94 Argent	Argento	-	-	-

TARAUDS À MACHINE NANO – MASCHI A MACCHINA NANO



Dès page :
Dalla pagina:

M
MF
UNC
UNF
S
SF
SL

TAN			
Matières normales Materiali normali			
338	338	338	338
341	341	341	341
344	344	344	344
347	347	347	347
350	350	350	350
353	353	353	353
356	356	356	356
TAN40	TAN40VS	TAN50	TAN50VS

TAZ			
Matières tenaces Materiali tenaci			
339	339	339	339
342	342	342	342
345	345	345	345
348	348	348	348
351	351	351	351
354	354	354	354
357	357	357	357
TAZ40	TAZ40VS	TAZ50	TAZ50VS

CMS	
Matières cassantes Materiali fragili	
340	340
343	343
346	346
349	349
352	352
355	355
358	358
CMS50	CMS50VS

Vc
(m/min) Guide Line

Ø 0.3 - 1.4 mm Ø 1.4 - 2.8 mm

	Standard Standard	Revêtu Rivestito	Standard Standard	Revêtu Rivestito
11		4 - 10		12 - 20
12		4 - 10		12 - 20
13		4 - 10		12 - 20
14		4 - 10		12 - 20
15				
16				
17				
18				
21		4 - 10		12 - 20
22		4 - 10		12 - 20
23		3 - 6		6 - 12
24		3 - 6		6 - 12
31		4 - 10		12 - 20
32		4 - 10		12 - 20
41	2 - 4	2 - 4	4 - 8	4 - 8
42	2 - 4	2 - 4	4 - 8	4 - 8
51				
52				
53				
61		4 - 10		12 - 20
62	4 - 10	4 - 10	12 - 20	12 - 20
63	4 - 10	4 - 10	12 - 20	12 - 20
64		4 - 10		12 - 20
71		4 - 10		12 - 20
72		4 - 10		12 - 20
73		4 - 10		12 - 20
74		4 - 10		12 - 20
81		4 - 10		12 - 20
82				
83		4 - 10		12 - 20
91	4 - 10		12 - 20	
92		4 - 10		12 - 20
93		4 - 10		12 - 20
94		4 - 10		12 - 20

A Optimale avec air
Ottimale con aria

A Fonctionnelle avec air
Funzionale con aria

Limitée
Limitato

Les valeurs ci-dessus sont indicatives.
I valori sopracitati sono indicativi.









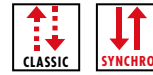







	TAN				TAZ	
Caractéristiques Caratteristiche		 VS		 VS		 VS
Genre de trou Tipo di foro						
	TAN40	TAN40VS	TAN50	TAN50VS	TAZ40	TAZ40VS
M 4H / 6H ISO DIN 14 ISO DIN 13 DC ~DIN 371	338	338	338	338	339	339
MF 4H / 6H ISO DIN 13 DC ~DIN 371	341	341	341	341	342	342
UNC 2B ASME B1.1 DC ~DIN 371	344	344	344	344	345	345
3B ASME B1.1 DC ~DIN 371	344	344	344	344	345	345
UNF 2B ASME B1.1 DC ~DIN 371	347	347	347	347	348	348
3B ASME B1.1 DC ~DIN 371	347	347	347	347	348	348
S NIHS NIHS 06 - 10 DC	350	350	350	350	351	351
SF NIHS NIHS 06-10 Fine Thread DC	353	353	353	353	354	354
SL Safelock SL 15 - 01 DC	356	356	356	356	357	357

Répertoire — Tarauds à machine nano

Rubrica — Maschi a macchina nano



TAZ		CMS	
	 		 
			
			
TAZ50	TAZ50VS	CMS50	CMS50VS
339	339	340	340
342	342	343	343
345	345	346	346
345	345	346	346
348	348	349	349
348	348	349	349
351	351	352	352
354	354	355	355
357	357	358	358

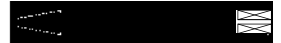

TAN

TAN40



62 63 91

TAN40VS



11 12 13 14 32 62
63 71 72 73 74 81
93

TAN50



62 63 91

TAN50VS



11 12 13 14 32 62
63 71 72 73 74 81
93

TAN40

TAN40VS

TAN50

TAN50VS

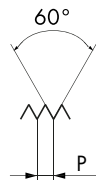
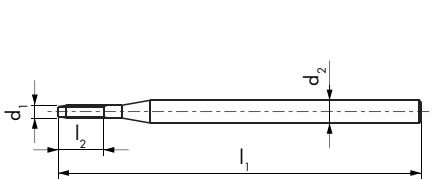

$\emptyset d_1$ M	P mm	l_1 mm	l_2 mm	d_2 mm		
0.5	0.125	25	1.5	2	3	$\Delta 0.41$
0.6	0.15	25	1.8	2	3	$\Delta 0.5$
0.7	0.175	25	2.1	2	3	$\Delta 0.58$
0.8	0.2	25	2.4	2	3	$\Delta 0.66$
0.9	0.225	25	2.7	2	3	$\Delta 0.74$
1	0.25	40	3.0	2.5	3	0.75
1.2	0.25	40	3.6	2.5	3	0.95
1.4	0.3	40	4.2	2.5	3	1.1

Δ 4H5H \rightarrow 4H6H = +0.02 mm

ID	ID	ID	ID
● 161817	● 161748	● 161818	● 161749
● 152512	● 152511	● 152545	● 151766
● 152516	● 152515	● 152548	● 152547
● 152520	● 152519	● 152552	● 152551
● 152524	● 152523	● 152555	● 152554
● 152528	● 152527	● 152558	● 151557
● 152531	● 151463	● 152562	● 152561
● 152534	● 151756	● 152565	● 151757

Δ 4H5H \rightarrow 4H6H = +0.02 mm

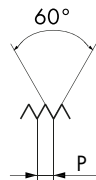
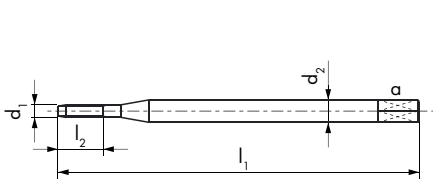

$\emptyset d_1$ M	P mm	l_1 mm	l_2 mm	d_2 mm	a mm		
1.6	0.35	40	4.8	2.5	3	1.25	
1.8	0.35	40	5.4	2.5	3	1.45	
2	0.4	45	8	2.8	2.1	3	1.6
2.3	0.4	45	9	2.8	2.1	3	1.9
2.5	0.45	50	10	2.8	2.1	3	2.05
2.6	0.45	50	10	2.8	2.1	3	2.15

ID	ID	ID	ID
● 152538	● 152537	● 152569	● 152568
● 193841	● 151461	● 193915	● 193952
● 152542	● 152541	● 152573	● 152572
● 193842	● 193878	● 193916	● 193953
● 193843	● 193879	● 193917	● 193954
● 193844	● 193880	● 193918	● 193955



TAZ

TAZ40



TAZ40VS

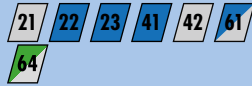

TAZ50



TAZ50VS

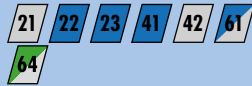

TAZ40

TAZ40VS

TAZ50

TAZ50VS

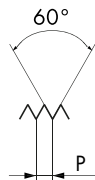
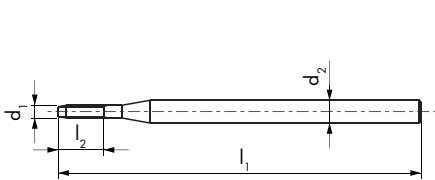

Ø d ₁ M	P mm	l ₁ mm	l ₂ mm	d ₂ mm		
0.5	0.125	25	1.5	2	3	Δ0.41
0.6	0.15	25	1.8	2	3	Δ0.5
0.7	0.175	25	2.1	2	3	Δ0.58
0.8	0.2	25	2.4	2	3	Δ0.66
0.9	0.225	25	2.7	2	3	Δ0.74
1	0.25	40	3	2.5	3	0.75
1.2	0.25	40	3.6	2.5	3	0.95
1.4	0.3	40	4.2	2.5	3	1.1

ID	ID	ID	ID
● 193994	● 194059	● 194119	● 194182
● 193995	● 194060	● 194120	● 194183
● 193996	● 194061	● 194121	● 194184
● 193997	● 194062	● 194122	● 194185
● 193998	● 194063	● 194123	● 194186
● 193999	● 194064	● 194124	● 183753
● 194000	● 194065	● 194125	● 194187
● 194001	● 194066	● 194126	● 194188

Δ 4H5H → 4H6H = +0.02 mm

Δ 4H5H → 4H6H = +0.02 mm

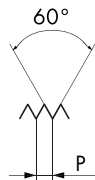
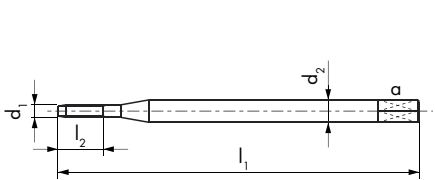

Ø d ₁ M	P mm	l ₁ mm	l ₂ mm	d ₂ mm	a mm		
1.6	0.35	40	4.8	2.5		3	1.25
1.8	0.35	40	5.4	2.5		3	1.45
2	0.4	45	8	2.8	2.1	3	1.6
2.3	0.4	45	9	2.8	2.1	3	1.9
2.5	0.45	50	10	2.8	2.1	3	2.05
2.6	0.45	50	10	2.8	2.1	3	2.15

ID	ID	ID	ID
● 194002	● 194067	● 194127	● 194189
● 194003	● 194068	● 194128	● 194190
● 194004	● 194947	● 194129	● 179266
● 194005	● 194069	● 194130	● 194191
● 194006	● 194070	● 194131	● 194192
● 194007	● 194071	● 194132	● 194193

CMS

CMS50



62 63 93

CMS50VS



31 62 63 73 74 83
93

CMS50

CMS50VS

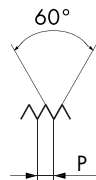
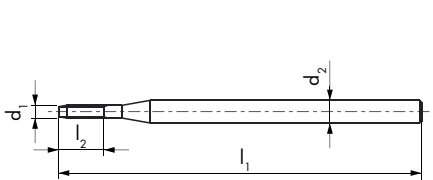

4H

4H

$\emptyset d_1$ M	P mm	l_1 mm	l_2 mm	d_2 h5 mm		
0.3	0.08	32	1.1	1.5	3	0.23
0.35	0.09	32	1.3	1.5	3	0.28
0.4	0.1	32	1.5	1.5	3	$\Delta 0.32$
0.5	0.125	32	1.8	1.5	3	$\Delta 0.41$
0.6	0.15	32	2.2	1.5	3	$\Delta 0.5$
0.7	0.175	32	2.6	1.5	3	$\Delta 0.58$
0.8	0.2	32	3	1.5	3	$\Delta 0.66$
0.9	0.225	32	3.3	1.5	3	$\Delta 0.74$
1	0.25	32	3.7	2	3	0.75
1.2	0.25	32	4.5	2	3	0.95
1.4	0.3	32	5.2	2	3	1.1

ID

ID

● 193639	● 193702
● 193640	● 193703
● 193641	● 193704
● 193642	● 193705
● 193643	● 193706
● 193644	● 193707
● 193645	● 193708
● 193646	● 193709
● 193647	● 193710
● 193648	● 193711
● 193649	● 193712

Δ 4H5H → 4H6H = +0.02 mm

≥ M1 - ≤ M1.4

ISO 1
4H

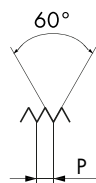
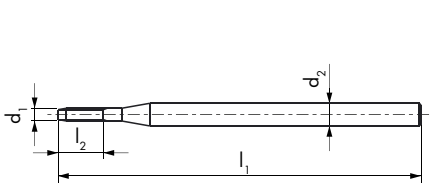

ISO 2
6H

ISO 2
6H

$\emptyset d_1$ M	P mm	l_1 mm	l_2 mm	d_2 h5 mm		
1.6	0.35	32	6	2	3	1.25
1.8	0.35	32	6.7	2	3	1.45
2	0.4	39	7.5	3	3	1.6
2.3	0.4	39	8.6	3	3	1.9
2.5	0.45	39	9.3	3	3	2.05
2.6	0.45	39	9.7	3	3	2.15

ID

ID

● 193650	● 193713
● 193651	● 193714
● 193652	● 193715
● 193653	● 193716
● 193654	● 193717
● 193655	● 193718



TAN

TAN40



62 63 91

TAN40VS



11 12 13 14 32 62
63 71 72 73 74 81
93

TAN50



62 63 91

TAN50VS



11 12 13 14 32 62
63 71 72 73 74 81
93

TAN40

TAN40VS

TAN50

TAN50VS

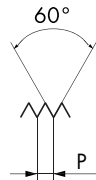
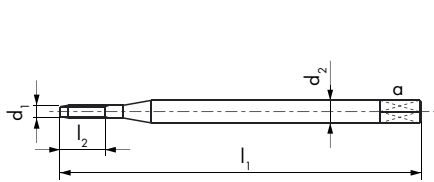

Ø d ₁ MF	P mm	l ₁ mm	l ₂ mm	d ₂ mm	a mm		
1.4	0.2	40	4.2	2.5		3	1.2
1.6	0.2	40	4.8	2.5		3	1.4
1.8	0.2	40	5.4	2.5		3	1.6
2	0.2	45	6	2.8	2.1	3	1.8
2	0.25	45	6	2.8	2.1	3	1.75
2.2	0.2	45	6.6	2.8	2.1	3	2
2.2	0.25	45	6.6	2.8	2.1	3	1.95
2.3	0.2	45	6.9	2.8	2.1	3	2.1
2.3	0.25	45	6.9	2.8	2.1	3	2.05
2.5	0.2	50	7.5	2.8	2.1	3	2.3
2.5	0.25	50	7.5	2.8	2.1	3	2.25

ID

ID

ID

ID

• 170390	• 193881	• 170393	• 156730
• 193845	• 193882	• 193919	• 193956
• 193846	• 193883	• 193920	• 180810
• 193847	• 193884	• 193921	• 184999
• 193848	• 193885	• 193922	• 182944
• 193849	• 193886	• 193923	• 179593
• 193850	• 193887	• 193924	• 193957
• 193851	• 193888	• 193925	• 193958
• 193852	• 193889	• 193926	• 193959
• 193853	• 193890	• 193927	• 193960
• 193854	• 193891	• 193928	• 193961

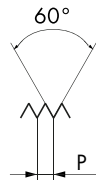
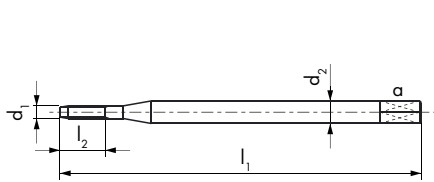

Ø d ₁ MF	P mm	l ₁ mm	l ₂ mm	d ₂ mm	a mm		
2.5	0.35	50	7.5	2.8	2.1	3	2.15
2.6	0.35	50	7.8	2.8	2.1	3	2.25

ID

ID

ID

ID

• 193855	• 193892	• 193929	• 193962
• 193856	• 193893	• 193930	• 193963



PM



TAZ

TAZ40



TAZ40VS



VS

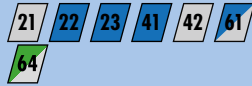

TAZ50



TAZ50VS



VS

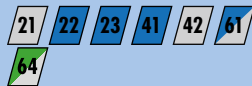

TAZ40

TAZ40VS

TAZ50

TAZ50VS

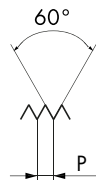
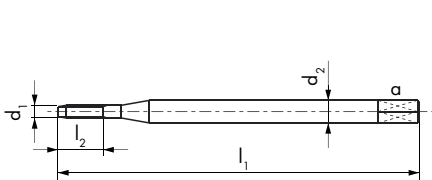

ISO 1
4H

ISO 1
4H

ISO 1
4H

ISO 1
4H

Ø d ₁ MF	P mm	l ₁ mm	l ₂ mm	d ₂ mm	a mm		
1.4	0.2	40	4.2	2.5		3	1.2
1.6	0.2	40	4.8	2.5		3	1.4
1.8	0.2	40	5.4	2.5		3	1.6
2	0.2	45	6	2.8	2.1	3	1.8
2	0.25	45	6	2.8	2.1	3	1.75
2.2	0.2	45	6.6	2.8	2.1	3	2
2.2	0.25	45	6.6	2.8	2.1	3	1.95
2.3	0.2	45	6.9	2.8	2.1	3	2.1
2.3	0.25	45	6.9	2.8	2.1	3	2.05
2.5	0.2	50	7.5	2.8	2.1	3	2.3
2.5	0.25	50	7.5	2.8	2.1	3	2.25

ID	ID	ID	ID
● 194008	● 194950	● 194133	● 194194
● 194009	● 194072	● 194134	● 181665
● 194010	● 194073	● 194135	● 190047
● 194011	● 194949	● 194136	● 194195
● 194012	● 194948	● 194137	● 185307
● 194013	● 194074	● 194138	● 194196
● 194014	● 194075	● 194139	● 194197
● 194015	● 194076	● 194140	● 194198
● 194016	● 194077	● 194141	● 194199
● 194017	● 194078	● 194142	● 194200
● 194018	● 194951	● 194143	● 194201

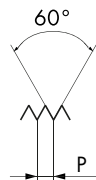
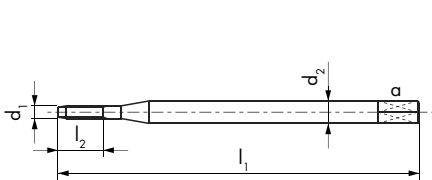

ISO 2
6H

ISO 2
6H

ISO 2
6H

ISO 2
6H

Ø d ₁ MF	P mm	l ₁ mm	l ₂ mm	d ₂ mm	a mm		
2.5	0.35	50	7.5	2.8	2.1	3	2.15
2.6	0.35	50	7.8	2.8	2.1	3	2.25

ID	ID	ID	ID
● 194019	● 194079	● 194144	● 194202
● 194020	● 194080	● 194145	● 194203



CMS

CMS50



62 63 93

CMS50VS



31 62 63 73 74 83 93

CMS50

CMS50VS

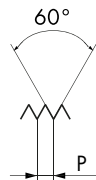
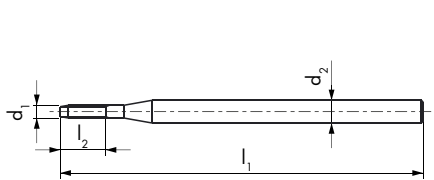

Ø d ₁ MF	P mm	l ₁ mm	l ₂ mm	d ₂ h5 mm		
1.4	0.2	32	5.2	2	3	1.2
1.6	0.2	32	6	2	3	1.4
1.8	0.2	32	6.7	2	3	1.6
2	0.2	39	7.5	3	3	1.8
2	0.25	39	7.5	3	3	1.75
2.2	0.2	39	8.2	3	3	2
2.2	0.25	39	8.2	3	3	1.95
2.3	0.2	39	8.6	3	3	2.1
2.3	0.25	39	8.6	3	3	2.05
2.5	0.2	39	9.3	3	3	2.3
2.5	0.25	39	9.3	3	3	2.25

ID

ID

- | | |
|----------|----------|
| ● 193656 | ● 193719 |
| ● 193657 | ● 193720 |
| ● 193658 | ● 193721 |
| ● 193659 | ● 193722 |
| ● 193660 | ● 193723 |
| ● 193661 | ● 193724 |
| ● 193662 | ● 193725 |
| ● 193663 | ● 193726 |
| ● 193664 | ● 193727 |
| ● 193665 | ● 193728 |
| ● 193666 | ● 193729 |

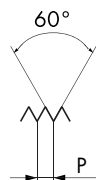
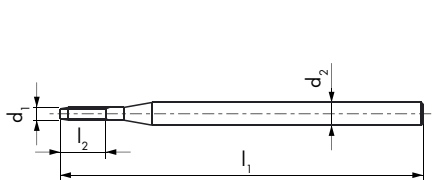

Ø d ₁ MF	P mm	l ₁ mm	l ₂ mm	d ₂ h5 mm		
2.5	0.35	39	9.3	3	3	2.15
2.6	0.35	39	9.7	3	3	2.25

ID

ID

- | | |
|----------|----------|
| ● 193667 | ● 193730 |
| ● 193668 | ● 193731 |



PM



TAN

TAN40



62 63 91

TAN40VS



VS

11 12 13 14 32 62
63 71 72 73 74 81
93

TAN50



62 63 91

TAN50VS



VS

11 12 13 14 32 62
63 71 72 73 74 81
93

TAN40

TAN40VS

TAN50

TAN50VS

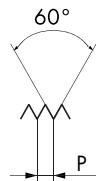
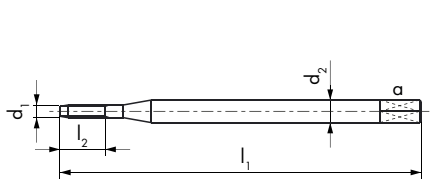

2B

2B

2B

2B

Ø d UNC	P TPI	d ₁ mm	l ₁ mm	l ₂ mm	d ₂ mm	a mm		
1	64	1.85	40	5.6	2.5	3	1.45	
2	56	2.18	45	9	2.8	2.1	1.75	
3	48	2.51	50	10	2.8	2.1	2	

ID

ID

ID

ID

● 193857	● 193894	● 193931	● 193964
● 193858	● 193895	● 193932	● 193965
● 193859	● 193896	● 193933	● 193966

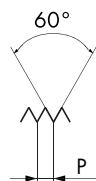
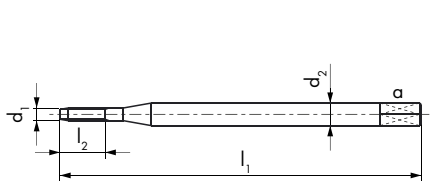

3B

3B

3B

3B

Ø d UNC(J)	P TPI	d ₁ mm	l ₁ mm	l ₂ mm	d ₂ mm	a mm		
1	64	1.85	40	5.6	2.5	3	1.45	
2	56	2.18	45	9	2.8	2.1	1.75	
3	48	2.51	50	10	2.8	2.1	2	

ID

ID

ID

ID

● 193860	● 193897	● 193934	● 193967
● 193861	● 193898	● 193935	● 193968
● 193862	● 193899	● 193936	● 193969



PM



TAZ

TAZ40



TAZ40VS



VS

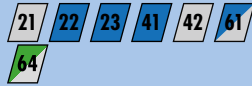

TAZ50



TAZ50VS



VS

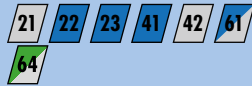

TAZ40

TAZ40VS

TAZ50

TAZ50VS

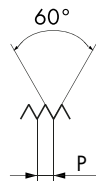
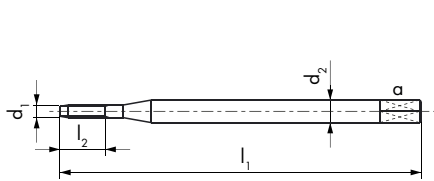

2B

2B

2B

2B

$\emptyset d_1$ UNC	P TPI	d_1 mm	l_1 mm	l_2 mm	d_2 mm	a mm		
1	64	1.85	40	5.6	2.5	3	1.45	
2	56	2.18	45	9	2.8	2.1	3	1.75
3	48	2.51	50	10	2.8	2.1	3	2

ID	ID	ID	ID
● 194021	● 194081	● 194146	● 194204
● 194022	● 194082	● 194147	● 194205
● 194023	● 194083	● 194148	● 194206

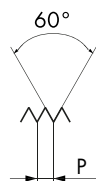
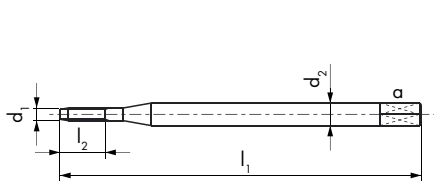

3B

3B

3B

3B

$\emptyset d_1$ UNC(J)	P TPI	d_1 mm	l_1 mm	l_2 mm	d_2 mm	a mm		
1	64	1.85	40	5.6	2.5	3	1.45	
2	56	2.18	45	9	2.8	2.1	3	1.75
3	48	2.51	50	10	2.8	2.1	3	2

ID	ID	ID	ID
● 194024	● 194084	● 194149	● 194207
● 194025	● 194085	● 194150	● 194208
● 194026	● 194086	● 194151	● 194209



CMS

CMS50



62 63 93

CMS50VS



31 62 63 73 74 83 93

CMS50

CMS50VS

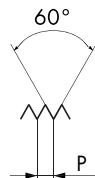
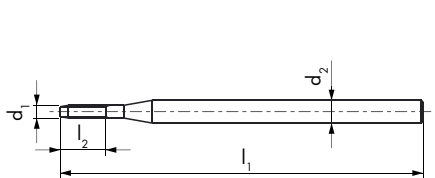

2B

2B

$\emptyset d_1$ UNC	P TPI	d_1 mm	l_1 mm	l_2 mm	d_2 h5 mm		
1	64	1.85	32	6.9	2	3	1.45
2	56	2.18	39	8.1	3	3	1.75
3	48	2.51	39	9.4	3	3	2

ID

ID

- | | |
|----------|----------|
| ● 193669 | ● 193732 |
| ● 193670 | ● 193733 |
| ● 193671 | ● 193734 |

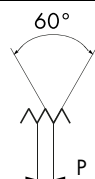
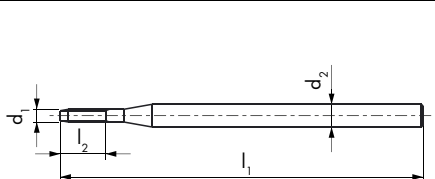

3B

3B

$\emptyset d_1$ UNC(J)	P TPI	d_1 mm	l_1 mm	l_2 mm	d_2 h5 mm		
1	64	1.85	32	6.9	2	3	1.45
2	56	2.18	39	8.1	3	3	1.75
3	48	2.51	39	9.4	3	3	2

ID

ID

- | | |
|----------|----------|
| ● 193672 | ● 193735 |
| ● 193673 | ● 193736 |
| ● 193674 | ● 193737 |

UNF ASME B1.1



PM



TAN

										TAN40	TAN40VS	TAN50	TAN50VS			
<p>TAN40 62 63 91</p> <p>TAN40VS VS 11 12 13 14 32 62 63 71 72 73 74 81 93</p> <p>TAN50 62 63 91</p> <p>TAN50VS VS 11 12 13 14 32 62 63 71 72 73 74 81 93</p>																
Ø d₁	P	d₁	l₁	l₂	d₂	a				ID	ID	ID	ID			
UNF	TPI	mm	mm	mm	mm	mm										
0	80	1.52	40	4.6	2.5		3	1.2	●	193863	●	193900	●	193937	●	193970
1	72	1.85	40	5.6	2.5		3	1.5	●	193864	●	193901	●	193938	●	193971
2	64	2.18	45	9	2.8	2.1	3	1.8	●	193865	●	193902	●	193939	●	193972
3	56	2.51	50	10	2.8	2.1	3	2.1	●	193866	●	193903	●	193940	●	193973
Ø d₁	P	d₁	l₁	l₂	d₂	a				ID	ID	ID	ID			
UNF(J)	TPI	mm	mm	mm	mm	mm										
0	80	1.52	40	4.6	2.5		3	1.2	●	193867	●	193904	●	193941	●	193974
1	72	1.85	40	5.6	2.5		3	1.5	●	193868	●	193905	●	193942	●	193975
2	64	2.18	45	9	2.8	2.1	3	1.8	●	193869	●	193906	●	193943	●	193976
3	56	2.51	50	10	2.8	2.1	3	2.1	●	193870	●	193907	●	193944	●	193977



PM



TAZ

TAZ40

TAZ40VS **VS**

TAZ50

TAZ50VS **VS**

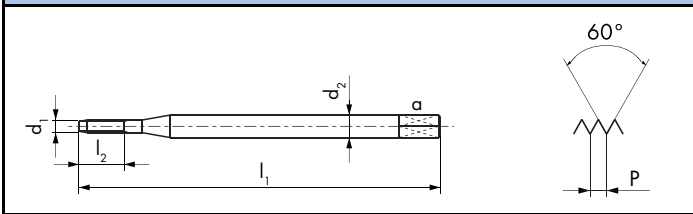
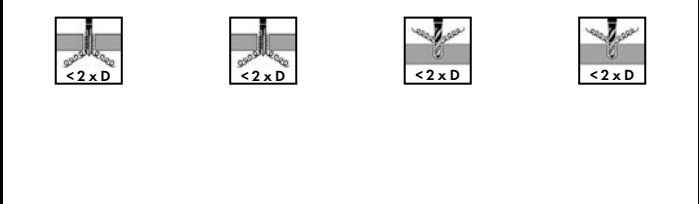
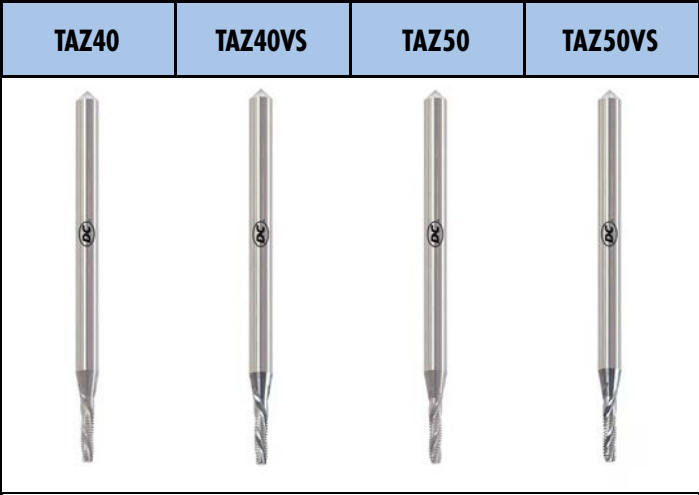

2B	2B	2B	2B

$\emptyset d_1$ UNF	P TPI	d_1 mm	l_1 mm	l_2 mm	d_2 mm	a mm		
0	80	1.52	40	4.6	2.5		3	1.2
1	72	1.85	40	5.6	2.5		3	1.5
2	64	2.18	45	9	2.8	2.1	3	1.8
3	56	2.51	50	10	2.8	2.1	3	2.1

ID	ID	ID	ID

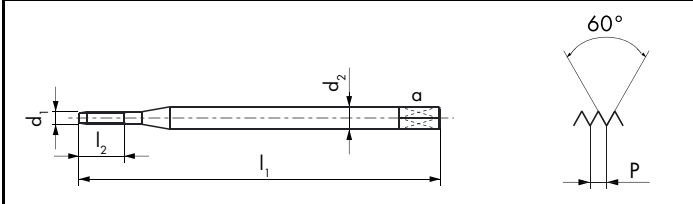

3B	3B	3B	3B
-----------	-----------	-----------	-----------

$\emptyset d_1$ UNF(J)	P TPI	d_1 mm	l_1 mm	l_2 mm	d_2 mm	a mm		
0	80	1.52	40	4.6	2.5		3	1.2
1	72	1.85	40	5.6	2.5		3	1.5
2	64	2.18	45	9	2.8	2.1	3	1.8
3	56	2.51	50	10	2.8	2.1	3	2.1

ID	ID	ID	ID



CMS

CMS50



62 63 93

CMS50VS



31 62 63 73 74 83 93

CMS50

CMS50VS

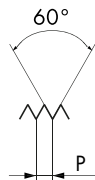
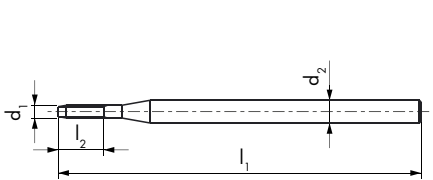

2B

2B

$\emptyset d_1$ UNF	P TPI	d_1 mm	l_1 mm	l_2 mm	d_2 h5 mm		
0	80	1.52	32	5.7	2	3	1.2
1	72	1.85	32	6.9	2	3	1.5
2	64	2.18	39	8.1	3	3	1.8
3	56	2.51	39	9.4	3	3	2.1

ID

ID

- | | |
|----------|----------|
| ● 193675 | ● 193738 |
| ● 193676 | ● 193739 |
| ● 193677 | ● 193740 |
| ● 193678 | ● 193741 |

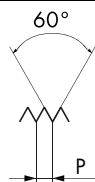
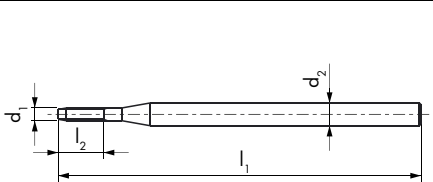

3B

3B

$\emptyset d_1$ UNF(J)	P TPI	d_1 mm	l_1 mm	l_2 mm	d_2 h5 mm		
0	80	1.52	32	5.7	2	3	1.2
1	72	1.85	32	6.9	2	3	1.5
2	64	2.18	39	8.1	3	3	1.8
3	56	2.51	39	9.4	3	3	2.1

ID

ID

- | | |
|----------|----------|
| ● 193679 | ● 193742 |
| ● 193680 | ● 193743 |
| ● 193681 | ● 193744 |
| ● 193682 | ● 193745 |



PM



TAN							TAN40	TAN40VS	TAN50	TAN50VS
<p>TAN40 62 63 91</p> <p>TAN40VS VS 11 12 13 14 32 62 63 71 72 73 74 81 93</p> <p>TAN50 62 63 91</p> <p>TAN50VS VS 11 12 13 14 32 62 63 71 72 73 74 81 93</p>										
$\varnothing d_1$ S	P mm	l_1 mm	l_2 mm	d_2 mm			ID	ID	ID	ID
0.5	0.125	25	1.5	2	3	$\Delta 0.41$	● 161816	● 157021	● 159301	● 158384
0.6	0.15	25	1.8	2	3	$\Delta 0.5$	● 152510	● 152509	● 151567	● 152544
0.7	0.175	25	2.1	2	3	$\Delta 0.58$	● 152514	● 152513	● 151768	● 152546
0.8	0.2	25	2.4	2	3	$\Delta 0.66$	● 152518	● 152517	● 152550	● 152549
0.9	0.225	25	2.7	2	3	$\Delta 0.74$	● 152522	● 152521	● 152553	● 151563
1	0.25	40	3	2.5	3	$\Delta 0.82$	● 152526	● 152525	● 152557	● 152556
1.2	0.25	40	3.6	2.5	3	$\Delta 1.02$	● 152530	● 152529	● 152560	● 152559
1.4	0.3	40	4.2	2.5	3	$\Delta 1.18$	● 152533	● 152532	● 152564	● 152563
<p>Δ 4H5H \rightarrow 4H6H = +0.02 mm</p>										



PM



TAZ							TAZ40	TAZ40VS	TAZ50	TAZ50VS
<p>TAZ40 </p> <p>TAZ40VS VS </p> <p>TAZ50 </p> <p>TAZ50VS VS </p>										
$\emptyset d_1$ S	P mm	l_1 mm	l_2 mm	d_2 mm			ID	ID	ID	ID
0.5	0.125	25	1.5	2	3	$\Delta 0.41$	● 193978	● 194043	● 194103	● 194168
0.6	0.15	25	1.8	2	3	$\Delta 0.5$	● 193979	● 194044	● 194104	● 194169
0.7	0.175	25	2.1	2	3	$\Delta 0.58$	● 193980	● 194045	● 194105	● 194170
0.8	0.2	25	2.4	2	3	$\Delta 0.66$	● 193981	● 194046	● 194106	● 188515
0.9	0.225	25	2.7	2	3	$\Delta 0.74$	● 193982	● 194047	● 194107	● 188521
1	0.25	40	3	2.5	3	$\Delta 0.82$	● 193983	● 194048	● 194108	● 194171
1.2	0.25	40	3.6	2.5	3	$\Delta 1.02$	● 193984	● 194049	● 194109	● 194172
1.4	0.3	40	4.2	2.5	3	$\Delta 1.18$	● 193985	● 194050	● 194110	● 194173
Δ 4H5H → 4H6H = +0.02 mm										



CMS

CMS50



62 63 93

CMS50VS



31 62 63 73 74 83
93

CMS50

CMS50VS

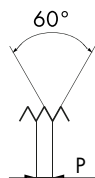
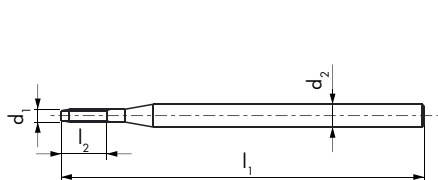

$\emptyset d_1$ S	P mm	l_1 mm	l_2 mm	d_2 h5 mm		
0.3	0.08	32	1.1	1.5	3	0.23
0.35	0.09	32	1.3	1.5	3	0.28
0.4	0.1	32	1.5	1.5	3	$\Delta 0.32$
0.5	0.125	32	1.8	1.5	3	$\Delta 0.41$
0.6	0.15	32	2.2	1.5	3	$\Delta 0.5$
0.7	0.175	32	2.6	1.5	3	$\Delta 0.58$
0.8	0.2	32	3	1.5	3	$\Delta 0.66$
0.9	0.225	32	3.3	1.5	3	$\Delta 0.74$
1	0.25	32	3.7	2	3	$\Delta 0.82$
1.2	0.25	32	4.5	2	3	$\Delta 1.02$
1.4	0.3	32	5.2	2	3	$\Delta 1.18$

ID

ID

● 178257	● 193683
● 178260	● 193684
● 178263	● 193685
● 178266	● 193686
● 178269	● 193687
● 178272	● 193688
● 178275	● 193689
● 178278	● 193690
● 178281	● 193691
● 178284	● 193692
● 178287	● 193693

Δ 4H5H \rightarrow 4H6H = +0.02 mm



TAN

TAN40



62 63 91

TAN40VS



VS

11 12 13 14 32 62
63 71 72 73 74 81
93

TAN50



62 63 91

TAN50VS



VS

11 12 13 14 32 62
63 71 72 73 74 81
93

TAN40

TAN40VS

TAN50

TAN50VS

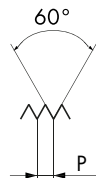
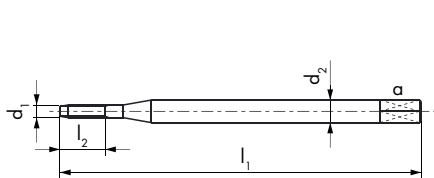

NIHS

NIHS

NIHS

NIHS

$\emptyset d_1$ SF	P mm	l_1 mm	l_2 mm	d_2 mm	a mm		
1.4	0.2	40	4.2	2.5		3	$\Delta 1.26$
1.6	0.2	40	4.8	2.5		3	$\Delta 1.46$
1.8	0.2	40	5.4	2.5		3	$\Delta 1.66$
2	0.2	45	6	2.8	2.1	3	$\Delta 1.86$
2.2	0.2	45	6.6	2.8	2.1	3	$\Delta 2.06$
2.2	0.25	45	6.6	2.8	2.1	3	$\Delta 2.02$
2.5	0.2	50	7.5	2.8	2.1	3	$\Delta 2.36$
2.5	0.25	50	7.5	2.8	2.1	3	$\Delta 2.32$

Δ 4H5H \rightarrow 4H6H = +0.02 mm

ID

ID

ID

ID

● 193833	● 170491	● 169767	● 170492
● 193834	● 193871	● 193908	● 193945
● 193835	● 193872	● 193909	● 193946
● 193836	● 193873	● 193910	● 193947
● 193837	● 193874	● 193911	● 193948
● 193838	● 193875	● 193912	● 193949
● 193839	● 193876	● 193913	● 193950
● 193840	● 193877	● 193914	● 193951



TAZ

TAZ40



TAZ40VS

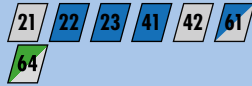

TAZ50



TAZ50VS

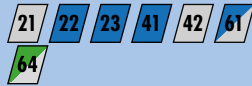

TAZ40

TAZ40VS

TAZ50

TAZ50VS

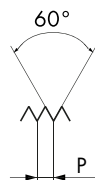
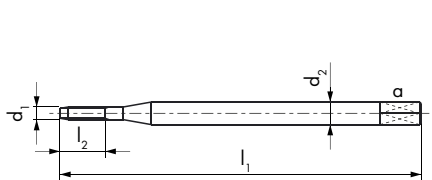

$\emptyset d_1$ SF	P mm	l_1 mm	l_2 mm	d_2 mm	a mm		
1.4	0.2	40	4.2	2.5		3	$\Delta 1.26$
1.6	0.2	40	4.8	2.5		3	$\Delta 1.46$
1.8	0.2	40	5.4	2.5		3	$\Delta 1.66$
2	0.2	45	6	2.8	2.1	3	$\Delta 1.86$
2.2	0.2	45	6.6	2.8	2.1	3	$\Delta 2.06$
2.2	0.25	45	6.6	2.8	2.1	3	$\Delta 2.02$
2.5	0.2	50	7.5	2.8	2.1	3	$\Delta 2.36$
2.5	0.25	50	7.5	2.8	2.1	3	$\Delta 2.32$

Δ 4H5H \rightarrow 4H6H = +0.02 mm

ID

ID

ID

ID

● 193986	● 194051	● 194111	● 194174
● 193987	● 194052	● 194112	● 194175
● 193988	● 194053	● 194113	● 194176
● 193989	● 194054	● 194114	● 194177
● 193990	● 194055	● 194115	● 194178
● 193991	● 194056	● 194116	● 194179
● 193992	● 194057	● 194117	● 194180
● 193993	● 194058	● 194118	● 194181



CMS

CMS50



62 63 93

CMS50VS



31 62 63 73 74 83
93

CMS50

CMS50VS

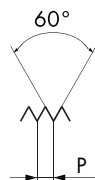
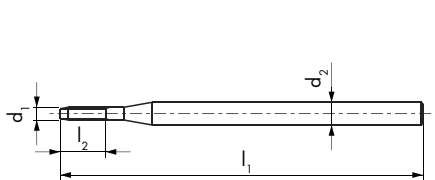

$\emptyset d_1$ SF	P mm	l_1 mm	l_2 mm	d_2 h5 mm		
1.4	0.2	32	5.2	2	3	$\Delta 1.26$
1.6	0.2	32	6	2	3	$\Delta 1.46$
1.8	0.2	32	6.7	2	3	$\Delta 1.66$
2	0.2	39	7.5	3	3	$\Delta 1.86$
2.2	0.2	39	8.2	3	3	$\Delta 2.06$
2.2	0.25	39	8.2	3	3	$\Delta 2.02$
2.5	0.2	39	9.3	3	3	$\Delta 2.36$
2.5	0.25	39	9.3	3	3	$\Delta 2.32$

ID	ID
● 180329	● 193694
● 193632	● 193695
● 193633	● 193696
● 193634	● 193697
● 193635	● 193698
● 193636	● 193699
● 193637	● 193700
● 193638	● 193701

Δ 4H5H \rightarrow 4H6H = +0.02 mm

TAN

TAN40



62 63 91

TAN40VS



11 12 13 14 32 62
63 71 72 73 74 81
93

TAN50



62 63 91

TAN50VS



11 12 13 14 32 62
63 71 72 73 74 81
93

TAN40

TAN40VS

TAN50

TAN50VS

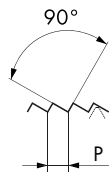
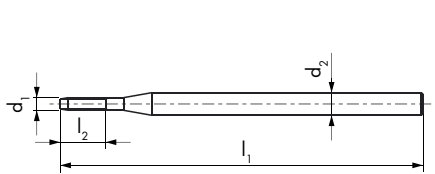

$\emptyset d_1$ SL	P mm	l_1 mm	l_2 mm	d_2 mm			ID	ID	ID	ID
0.5	0.1	25	1.5	2	3	0.46	● 600065	● 600073	● 600081	● 600089
0.6	0.125	25	1.8	2	3	0.55	● 600066	● 600074	● 600082	● 600090
0.7	0.15	25	2.1	2	3	0.64	● 600067	● 600075	● 600083	● 600091
0.8	0.15	25	2.4	2	3	0.74	● 600068	● 600076	● 600084	● 600092
0.9	0.175	25	2.7	2	3	0.83	● 600069	● 600077	● 600085	● 600093
1	0.2	40	3	2.5	3	0.92	● 600070	● 600078	● 600086	● 600094
1.2	0.2	40	3.6	2.5	3	1.12	● 600071	● 600079	● 600087	● 600095
1.4	0.25	40	4.2	2.5	3	1.3	● 600072	● 600080	● 600088	● 600096

TAZ

TAZ40



TAZ40VS

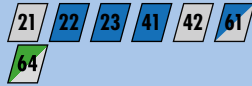

TAZ50



TAZ50VS

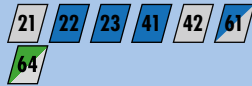

TAZ40

TAZ40VS

TAZ50

TAZ50VS

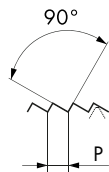
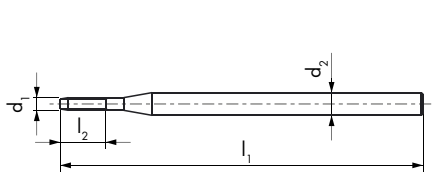

$\emptyset d_1$ SL	P mm	l_1 mm	l_2 mm	d_2 mm			ID	ID	ID	ID
0.5	0.1	25	1.5	2	3	0.46	● 600210	● 600218	● 600194	● 600202
0.6	0.125	25	1.8	2	3	0.55	● 600211	● 600219	● 600195	● 600203
0.7	0.15	25	2.1	2	3	0.64	● 600212	● 600220	● 600196	● 600204
0.8	0.15	25	2.4	2	3	0.74	● 600213	● 600221	● 600197	● 600205
0.9	0.175	25	2.7	2	3	0.83	● 600214	● 600222	● 600198	● 600206
1	0.2	40	3	2.5	3	0.92	● 600215	● 600223	● 600199	● 600207
1.2	0.2	40	3.6	2.5	3	1.12	● 600216	● 600224	● 600200	● 600208
1.4	0.25	40	4.2	2.5	3	1.3	● 600217	● 600225	● 600201	● 600209

CMS

CMS50



62 63 93

CMS50VS



31 62 63 73 74 83
93

CMS50

CMS50VS

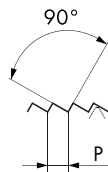
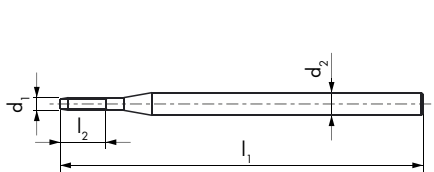

$\emptyset d_1$ SL	P mm	l_1 mm	l_2 mm	$d_2 h_5$ mm		
0.3	0.06	32	1.1	1.5	3	0.27
0.35	0.06	32	1.3	1.5	3	0.32
0.4	0.08	32	1.5	1.5	3	0.36
0.5	0.1	32	1.8	1.5	3	0.46
0.6	0.125	32	2.2	1.5	3	0.55
0.7	0.15	32	2.6	1.5	3	0.64
0.8	0.15	32	3	1.5	3	0.74
0.9	0.175	32	3.3	1.5	3	0.83
1	0.2	32	3.7	2	3	0.92
1.2	0.2	32	4.5	2	3	1.12
1.4	0.25	32	5.2	2	3	1.3

ID

ID

● 600097	● 600226
● 600098	● 600227
● 600099	● 600228
● 600039	● 600229
● 600040	● 600230
● 600041	● 600231
● 600042	● 600232
● 600043	● 600233
● 600044	● 600234
● 600045	● 600235
● 600046	● 600236



H | PERSEVERING THREADING



TARAUDS À REFOULER NANO
MASCHI A RULLARE NANO

DC Classification des matières

DC Classificazione dei materiali

Groupes de matières Gruppi di materiali	Désignation des matières	Designazione dei materiali	Dureté Durezza (HB)	Résistance Resistenza Rm (N/mm ²)	Allongement Allungamento A (%)
10 Aciers Acciai	11 Aciers de décolletage	Acciai da tornitura	< 200	< 700	< 10
	12 Aciers de construction ou de cémentation	Acciai da costruzione / da cementazione	< 200	< 700	< 30
	13 Aciers au carbone	Acciai al carbonio	< 300	< 1000	< 20
	14 Aciers alliés < 850 N/mm ²	Acciai legati < 850 N/mm ²	< 250	< 850	< 30
	15 Aciers alliés / traités > 850 - < 1150 N/mm ²	Acciai legati / trattati > 850 - < 1150 N/mm ²	> 250	> 850	< 30
	16 Aciers haute résistance ≤ 44 HRC	Acciai ad alta resistenza ≤ 44 HRC	> 250	> 850	< 12
	17 Aciers améliorés > 44 - ≤ 54 HRC	Acciai bonificati > 44 - ≤ 54 HRC	> 410	> 1400	< 2
	18 Aciers trempés > 54 - ≤ 63 HRC	Acciai temprati > 54 - ≤ 63 HRC	> 560	> 1980	< 2
20 Aciers inoxydables Acciai inox	21 Aciers inoxydables, soufrés	Acciai inox, allo zolfo	< 250	< 850	< 25
	22 Austénitiques	Acciai inox, austenitici	< 250	< 850	> 20
	23 Ferritiques et martensitiques < 850 N/mm ²	Ferritici e martensitici < 850 N/mm ²	< 250	< 850	> 20
	24 Ferritiques et martensitiques > 850 - < 1150 N/mm ²	Ferritici e martensitici > 850 - < 1150 N/mm ²	> 250	> 850	> 15
30 Fonte Ghisa	31 Fonte grise	Ghisa grigia	< 250	< 850	< 10
	32 Fonte à graphite sphéroïdale et malléable	Ghisa grafitica sferoidale e malleabile	< 250	< 850	> 10
40 Titane Titanio	41 Titane pur	Titanio puro	< 250	< 850	> 20
	42 Alliage de titane	Leghe di titanio	> 250	> 850	< 20
50 Nickel Nickel	51 Alliage de nickel 1 ≤ 850 N/mm ²	Leghe di nickel 1 ≤ 850 N/mm ²	< 250	< 850	> 25
	52 Alliage de nickel 2 > 850 - ≤ 1150 N/mm ²	Leghe di nickel 2 > 850 - ≤ 1150 N/mm ²	> 250	> 850	< 25
	53 Alliage de nickel 3 > 1150 - ≤ 1600 N/mm ²	Leghe di nickel 3 > 1150 - ≤ 1600 N/mm ²	> 340	> 1150	< 20
60 Cuivre Rame	61 Cuivre pur (électrolytique)	Rame puro (elettrolitico)	< 120	< 400	> 12
	62 Laiton, bronze (copeaux courts)	Ottone, bronzo (trucioli corti)	< 200	< 700	< 12
	63 Laiton (copeaux longs)	Ottone (trucioli lunghi)	< 200	< 700	> 12
	64 Laiton sans plomb	Ottone senza piombo	< 220	< 700	> 15
70 Aluminium Magnésium Alluminio Magnesio	71 Al non allié	Alluminio non legato	< 100	< 350	> 15
	72 Al allié Si < 1.5 %	Leghe di alluminio Si < 1.5 %	< 150	< 500	> 15
	73 Al allié Si > 1.5 % - < 10 %	Leghe di alluminio Si > 1.5 % - < 10 %	< 120	< 400	< 15
	74 Al allié Si > 10 %, alliages de magnésium	Leghe di al. Si > 10 %, leghe di magnesio	< 120	< 400	< 10
80 Matières plastiques Materie plastiche	81 Matières thermoplastiques	Materie termoplastiche	-	-	-
	82 Matières duroplastiques	Materie termoindurenti	-	-	-
	83 Matières plastiques renforcées par fibres	Materie plastiche rinforzate con fibre	-	-	-
90 Métaux précieux Metalli preziosi	91 Or jaune	Oro giallo	-	-	-
	92 Or rose	Oro rosso	-	-	-
	93 Or blanc	Oro bianco	-	-	-
	94 Argent	Argento	-	-	-

















TARAUDS À REFOULER NANO — MASCHI A RULLARE NANO



Dès page :
Dalla pagina:

M
MF
UNC
UNF
S
SF
SL

	Vc (m/min) Guide Line		FA		CFA		
			Matières normales Materiali normali		Matériaux non-ferreux Materiali non ferrosi		
	Ø 0.3 - 1.4 mm Revêtu Rivestito	Ø 1.4 - 2.8 mm Revêtu Rivestito	363 364 365 366 367 368 369	363 364 365 366 367 368 369	370 371 372 373	370 371 372 373	
11	4 - 10	12 - 20					11
12	4 - 10	12 - 20					12
13	4 - 10	12 - 20					13
14	4 - 10	12 - 20					14
15	3 - 6	6 - 12					15
16							16
17							17
18							18
21	4 - 10	12 - 20					21
22	3 - 6	6 - 12					22
23	3 - 6	6 - 12					23
24	3 - 6	6 - 12					24
31							31
32							32
41							41
42							42
51	3 - 6	6 - 12					51
52							52
53							53
61	4 - 10	12 - 20					61
62	4 - 10	12 - 20					62
63	4 - 10	12 - 20					63
64	4 - 10	12 - 20					64
71	4 - 10	12 - 20					71
72	4 - 10	12 - 20					72
73	4 - 10	12 - 20					73
74							74
81							81
82							82
83							83
91	4 - 10	12 - 20					91
92	4 - 10	12 - 20					92
93	4 - 10	12 - 20					93
94	4 - 10	12 - 20					94

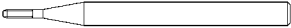
	FA				CFA			
Caractéristiques Caratteristiche		VS		VS		VS		VS
								
								
Genre de trou Tipo di foro								
	FA80VS	FA83VS	CFA80VS	CFA83VS				
M 4HX / 6HX ISO DIN 14 ISO DIN 13 DC ~DIN 371	363	363	370	370				
MF 4HX / 6HX ISO DIN 13 DC ~DIN 371	364	364						
UNC 2BX ASME B1.1 DC ~DIN 371	365	365	371	371				
3BX ASME B1.1 DC ~DIN 371	365	365						
UNF 2BX ASME B1.1 DC ~DIN 371	366	366	372	372				
3BX ASME B1.1 DC ~DIN 371	366	366						
S NIHS NIHS 06 - 10 DC	367	367	373	373				
SF NIHS NIHS 06-10 Fine Thread DC	368	368						
SL Safelock SL 15 - 01 DC	369	369						



FA

FA80VS

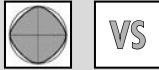

VS

FA83VS



VS



FA80VS

FA83VS

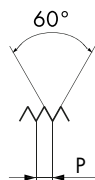
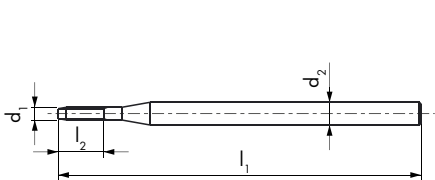

$\varnothing d_1$ M	P mm	l_1 mm	l_2 mm	d_2 mm		ID	ID
0.5	0.125	25	1.5	2	$\Delta 0.44$	● 161750	● 173719
0.6	0.15	25	1.8	2	$\Delta 0.53$	● 152412	● 173720
0.7	0.175	25	2.1	2	$\Delta 0.62$	● 152415	● 173721
0.8	0.2	25	2.4	2	$\Delta 0.71$	● 152418	● 173722
0.9	0.225	25	2.7	2	$\Delta 0.8$	● 152421	● 173723
1	0.25	40	3	2.5	$\Delta 0.88$	● 151559	● 173729
1.2	0.25	40	3.6	2.5	$\Delta 1.08$	● 151565	● 173730
1.4	0.3	40	4.2	2.5	$\Delta 1.25$	● 152429	● 173731

Δ Tol. = +0/0.02 mm

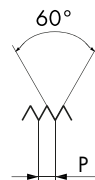
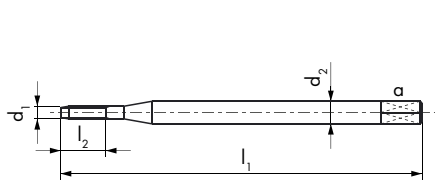

$\varnothing d_1$ M	P mm	l_1 mm	l_2 mm	d_2 mm	a mm		ID	ID
1.6	0.35	40	4.8	2.5		$\Delta 1.45$	● 152433	● 193801
1.8	0.35	40	5.4	2.5		$\Delta 1.65$	● 193764	● 193802
2	0.4	45	8	2.8	2.1	$\Delta 1.8$	● 151566	● 193803
2.3	0.4	45	9	2.8	2.1	$\Delta 2.1$	● 193765	● 193804
2.5	0.45	50	10	2.8	2.1	$\Delta 2.3$	● 193766	● 193805
2.6	0.45	50	10	2.8	2.1	$\Delta 2.4$	● 193767	● 193806

Δ Tol. = +0/0.02 mm



FA

FA80VS

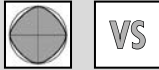

FA83VS



FA80VS

FA83VS

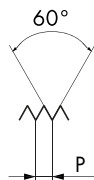
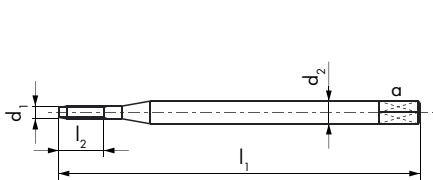

4HX

4HX

$\varnothing d_1$ MF	P mm	l_1 mm	l_2 mm	d_2 mm	a mm	
1.4	0.2	40	4.2	2.5		$\Delta 1.31$
1.6	0.2	40	4.8	2.5		$\Delta 1.51$
1.8	0.2	40	5.4	2.5		$\Delta 1.71$
2	0.2	45	6	2.8	2.1	$\Delta 1.91$
2	0.25	45	6	2.8	2.1	$\Delta 1.88$
2.2	0.2	45	6.6	2.8	2.1	$\Delta 2.11$
2.2	0.25	45	6.6	2.8	2.1	$\Delta 2.08$
2.3	0.2	45	6.9	2.8	2.1	$\Delta 2.21$
2.3	0.25	45	6.9	2.8	2.1	$\Delta 2.18$
2.5	0.2	50	7.5	2.8	2.1	$\Delta 2.41$
2.5	0.25	50	7.5	2.8	2.1	$\Delta 2.38$

ID

ID

● 155928	● 180436
● 156480	● 193807
● 193768	● 193808
● 193769	● 193809
● 193770	● 193810
● 193771	● 193811
● 193772	● 193812
● 193773	● 193813
● 193774	● 193814
● 193775	● 193815
● 193776	● 193816

Δ Tol. = +0/0.02 mm

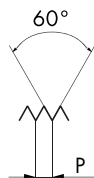
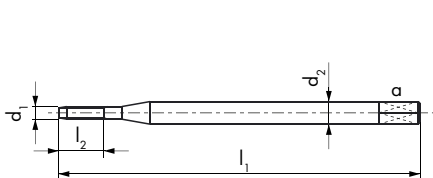

6HX

6HX

$\varnothing d_1$ MF	P mm	l_1 mm	l_2 mm	d_2 mm	a mm	
2.5	0.35	50	7.5	2.8	2.1	$\Delta 2.35$
2.6	0.35	50	7.8	2.8	2.1	$\Delta 2.45$

ID

ID

● 193777	● 193817
● 193778	● 193818

Δ Tol. = +0/0.02 mm



FA

FA80VS  VS

FA83VS  VS

11	12	13	14	15
21	22	23	24	51
61	63	64	71	72
73	91	92	94	

FA80VS

FA83VS

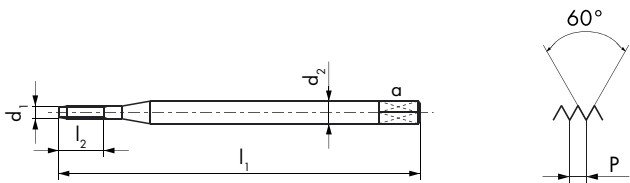

2BX

2BX

$\emptyset d_1$ UNC	P TPI	d_1 mm	l_1 mm	l_2 mm	d_2 mm	a mm	
1	64	1.85	40	5.6	2.5		$\Delta 1.65$
2	56	2.18	45	9	2.8	2.1	$\Delta 2$
3	48	2.51	50	10	2.8	2.1	$\Delta 2.25$

ID

ID

- | | |
|--|--|
| ● 193779 | ● 193819 |
| ● 193780 | ● 193820 |
| ● 193781 | ● 193821 |

Δ  Tol. = +0/0.02 mm

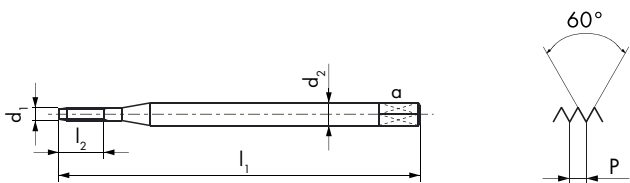

3BX

3BX

$\emptyset d_1$ UNC	P TPI	d_1 mm	l_1 mm	l_2 mm	d_2 mm	a mm	
1	64	1.85	40	5.6	2.5		$\Delta 1.65$
2	56	2.18	45	9	2.8	2.1	$\Delta 2$
3	48	2.51	50	10	2.8	2.1	$\Delta 2.25$

ID



ID



- | | |
|--|--|
| ● 193782 | ● 193822 |
| ● 193783 | ● 193823 |
| ● 193784 | ● 193824 |

Δ  Tol. = +0/0.02 mm



FA

FA80VS  

FA83VS  

11	12	13	14	15
21	22	23	24	51
61	63	64	71	72
73	91	92	94	

FA80VS

FA83VS

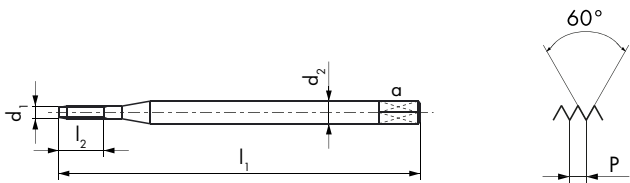

2BX

2BX

$\emptyset d_1$ UNF	P TPI	d_1 mm	l_1 mm	l_2 mm	d_2 mm	a mm	
0	80	1.52	40	4.6	2.5		$\Delta 1.4$
1	72	1.85	40	5.6	2.5		$\Delta 1.7$
2	64	2.18	45	9	2.8	2.1	$\Delta 2$
3	56	2.51	50	10	2.8	2.1	$\Delta 2.3$

Δ  Tol. = +0/0.02 mm

ID

ID

- | | |
|--|--|
| ● 193785 | ● 193825 |
| ● 193786 | ● 193826 |
| ● 193787 | ● 193827 |
| ● 193788 | ● 193828 |

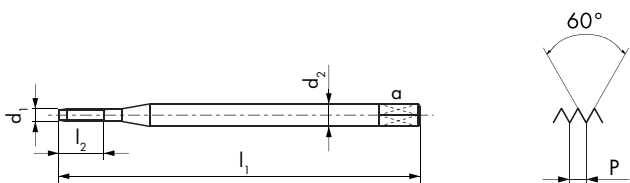

3BX

3BX

$\emptyset d_1$ UNF	P TPI	d_1 mm	l_1 mm	l_2 mm	d_2 mm	a mm	
0	80	1.52	40	4.6	2.5		$\Delta 1.4$
1	72	1.85	40	5.6	2.5		$\Delta 1.7$
2	64	2.18	45	9	2.8	2.1	$\Delta 2$
3	56	2.51	50	10	2.8	2.1	$\Delta 2.3$

Δ  Tol. = +0/0.02 mm

ID

ID

- | | |
|--|--|
| ● 193789 | ● 193829 |
| ● 193790 | ● 193830 |
| ● 193791 | ● 193831 |
| ● 193792 | ● 193832 |



PM



FA

FA80VS



VS

FA83VS



VS



FA80VS

FA83VS

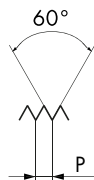
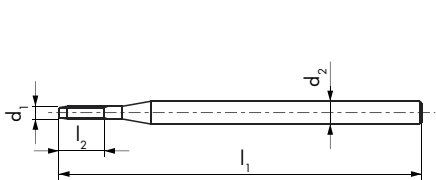

NIHS

NIHS

$\varnothing d_1$ S	P mm	l_1 mm	l_2 mm	d_2 mm	
0.5	0.125	25	1.5	2	$\Delta 0.44$
0.6	0.15	25	1.8	2	$\Delta 0.53$
0.7	0.175	25	2.1	2	$\Delta 0.62$
0.8	0.2	25	2.4	2	$\Delta 0.71$
0.9	0.225	25	2.7	2	$\Delta 0.8$
1	0.25	40	3.0	2.5	$\Delta 0.88$
1.2	0.25	40	3.6	2.5	$\Delta 1.08$
1.4	0.3	40	4.2	2.5	$\Delta 1.25$

ID

ID

● 158977	● 173724
● 151561	● 173725
● 151742	● 173726
● 151564	● 173727
● 151562	● 173728
● 151542	● 173732
● 151543	● 173733
● 152427	● 173734

Δ Tol. = +0/0.02 mm



FA

FA80VS



11	12	13	14	15
21	22	23	24	51
61	63	64	71	72
73	91	92	94	

FA83VS



FA80VS

FA83VS

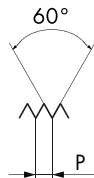
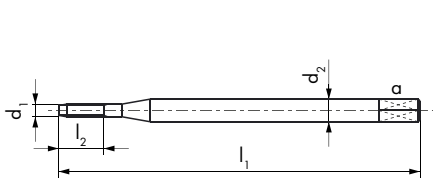

$\emptyset d_1$ SF	P mm	l_1 mm	l_2 mm	d_2 mm	a mm	
1.4	0.2	40	4.2	2.5		$\Delta 1.31$
1.6	0.2	40	4.8	2.5		$\Delta 1.51$
1.8	0.2	40	5.4	2.5		$\Delta 1.71$
2	0.2	45	6	2.8	2.1	$\Delta 1.91$
2.2	0.2	45	6.6	2.8	2.1	$\Delta 2.11$
2.2	0.25	45	6.6	2.8	2.1	$\Delta 2.08$
2.5	0.2	50	7.5	2.8	2.1	$\Delta 2.41$
2.5	0.25	50	7.5	2.8	2.1	$\Delta 2.38$

ID	ID
● 176180	● 193793
● 193757	● 193794
● 193758	● 193795
● 193759	● 193796
● 193760	● 193797
● 193761	● 193798
● 193762	● 193799
● 193763	● 193800

Δ Tol. = +0/0.02 mm

FA

FA80VS



FA83VS



FA80VS

FA83VS

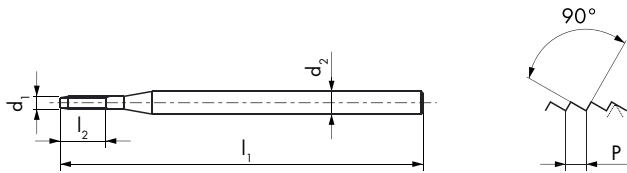

$\emptyset d_1$ SL	P mm	l_1 mm	l_2 mm	d_2 mm
0.5	0.1	25	1.5	2
0.6	0.125	25	1.8	2
0.7	0.15	25	2.1	2
0.8	0.15	25	2.4	2
0.9	0.175	25	2.7	2
1	0.2	40	3	2.5
1.2	0.2	40	3.6	2.5
1.4	0.25	40	4.2	2.5

ID

ID

● 600049	● 600100
● 600050	● 600101
● 600051	● 600102
● 600052	● 600103
● 600053	● 600104
● 600054	● 600105
● 600055	● 600106
● 600056	● 600107

CFA

CFA80VS



62 63 91 92 94

CFA83VS



CFA80VS

CFA83VS



4HX

4HX

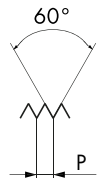
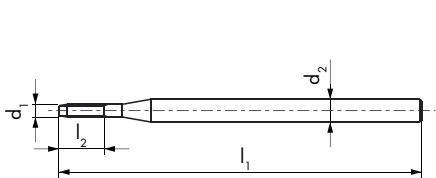

$\emptyset d_1$ M	P mm	l_1 mm	l_2 mm	d_2 h5 mm	
0.5	0.125	32	1.5	1.5	$\Delta 0.44$
0.6	0.15	32	1.8	1.5	$\Delta 0.53$
0.7	0.175	32	2.1	1.5	$\Delta 0.62$
0.8	0.2	32	2.4	1.5	$\Delta 0.71$
0.9	0.225	32	2.7	1.5	$\Delta 0.8$
1	0.25	32	3	2	$\Delta 0.88$
1.2	0.25	32	3.6	2	$\Delta 1.08$
1.4	0.3	32	4.2	2	$\Delta 1.25$

Δ Tol. = +0/0.02 mm

ID

ID

● 171771	● 193611
● 171773	● 193612
● 171775	● 193613
● 171777	● 193614
● 171779	● 193615
● 171782	● 193616
● 171783	● 193617
● 171785	● 193618

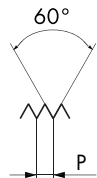
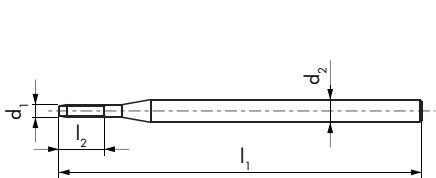

$\emptyset d_1$ M	P mm	l_1 mm	l_2 mm	d_2 h5 mm	
1.6	0.35	32	4.8	2	$\Delta 1.45$
1.8	0.35	32	5.4	2	$\Delta 1.65$
2	0.4	39	8	3	$\Delta 1.8$
2.3	0.4	39	9	3	$\Delta 2.1$
2.5	0.45	39	10	3	$\Delta 2.3$
2.6	0.45	39	10	3	$\Delta 2.4$

Δ Tol. = +0/0.02 mm

6HX

6HX

ID

ID

● 193590	● 193619
● 193591	● 193620
● 193592	● 193621
● 193593	● 193622
● 193594	● 193623
● 193595	● 193624

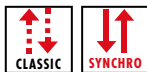

CFA

CFA80VS



62 63 91 92 94

CFA83VS



CFA80VS

CFA83VS

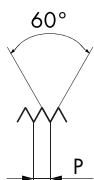
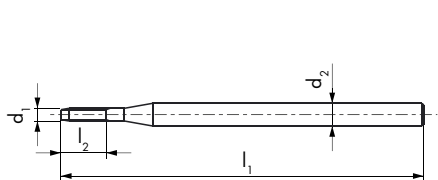

$\emptyset d$ UNC	P TPI	d_1 mm	l_1 mm	l_2 mm	d_2 h5 mm	
1	64	1.85	32	5.5	2	$\Delta 1.65$
2	56	2.18	39	8.6	3	$\Delta 2$
3	48	2.51	39	10	3	$\Delta 2.25$

ID

ID

● 193596	● 193625
● 193597	● 193626
● 193598	● 193627

Δ Tol. = +0/0.02 mm



CFA

CFA80VS

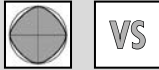

62 63 91 92 94

CFA83VS



CFA80VS

CFA83VS



2BX

2BX

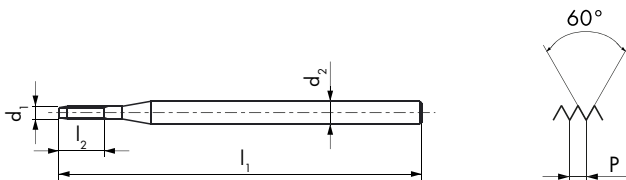

$\emptyset d$ UNF	P TPI	d_1 mm	l_1 mm	l_2 mm	d_2 ^{h5} mm	
0	80	1.52	32	4.5	2	$\Delta 1.4$
1	72	1.85	32	5.5	2	$\Delta 1.7$
2	64	2.18	39	8.6	3	$\Delta 2$
3	56	2.51	39	10	3	$\Delta 2.3$

ID	ID
● 193599	● 193628
● 193600	● 193629
● 193601	● 193630
● 193602	● 193631

Δ Tol. = +0/0.02 mm



CFA

CFA80VS

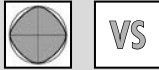

62 63 91 92 94

CFA83VS



CFA80VS

CFA83VS

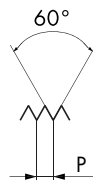
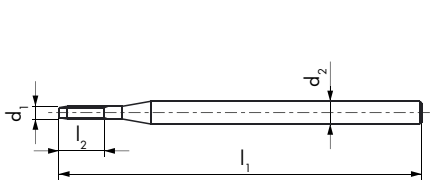

$\varnothing d_1$ S	P mm	l_1 mm	l_2 mm	d_2 h5 mm	
0.5	0.125	32	1.5	1.5	$\Delta 0.44$
0.6	0.15	32	1.8	1.5	$\Delta 0.53$
0.7	0.175	32	2.1	1.5	$\Delta 0.62$
0.8	0.2	32	2.4	1.5	$\Delta 0.71$
0.9	0.225	32	2.7	1.5	$\Delta 0.8$
1	0.25	32	3	2	$\Delta 0.88$
1.2	0.25	32	3.6	2	$\Delta 1.08$
1.4	0.3	32	4.2	2	$\Delta 1.25$

ID

ID

● 171770	● 193603
● 171772	● 193604
● 171774	● 193605
● 171776	● 193606
● 171778	● 193607
● 171780	● 193608
● 171781	● 193609
● 171784	● 193610

Δ Tol. = +0/0.02 mm

JAUGES DE FILETAGE NANO CALIBRI FILETTATI PER FILETTATURA NANO

JAUGES TAMPONS DE FILETAGE — CALIBRI A TAMPONE FILETTATI



MÉTROLOGIE — METROLOGIA



PRODUCTION — PRODUZIONE



< 2.74 mm



UTILISATION

Le meulage du 1er filet non plein et de la face avant de la jauge garantit un engagement optimal dans le filetage, primordial pour assurer une mesure correcte. Cette entrée permet à la jauge de contrôler le filetage à une profondeur maximale.

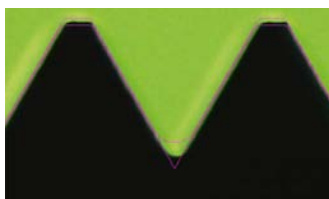

MAÎTRISE DU PROFIL

Notre savoir-faire dans le domaine de la rectification nous garantit une parfaite maîtrise des tolérances de la forme du profil et des états de surface parfaits.



JAUGE BAGUE NO-GO

Le dégagement du Ø extérieur de nos jauges bagues NO-GO assure une vérification parfaite des flancs de vis en éliminant le risque d'un contrôle faussé par un blocage sur le diamètre extérieur de la jauge.



SYSTÈME MODULAIRE

Une vis de raccord permet d'assembler la jauge GO avec la partie NO-GO selon votre besoin. La boîte rigide sécurise les jauges pendant le transport et les déplacements. Son intérieur moulé protège le produit des chocs et des salissures.

TAMPONS RAPPORTEURS — TAMPONI DI CONTROLLO

Le tampon rapporteur NO-GO sera le garde-fou de la nouvelle bague.

Il tampone di controllo NO-GO è il dispositivo di controllo per il nuovo calibro ad anello.

Le tampon rapporteur GO servira à contrôler la qualité de votre bague.

Il tampone di controllo GO viene utilizzato per controllare la qualità del vostro calibro ad anello.



Le témoin d'usure WEAR prolongera la durée de vie de votre bague jusqu'à un certain seuil de tolérance.

Il tampone master WEAR prolunga la vita utile del vostro tampone ad anello fino ad un certo limite di tolleranza.

UTILIZZAZIONE

Il fatto che il giro iniziale della filettatura della vite e anche la punta del calibro siano stati rettificati in piano assicura che l'utensile si inserisca in modo ottimale nella filettatura, il che è essenziale per garantire una misurazione corretta. Ciò consente al calibro di controllare il filetto alla sua massima profondità.

CONTROLLO DEL PROFILO

La nostra esperienza nel campo della rettifica ci assicura un perfetto controllo delle tolleranze per la forma del profilo e per la struttura delle superfici.

CALIBRO AD ANELLO NO-GO

Il profilo sul diametro esterno dei nostri tamponi ad anello NO-GO garantisce un controllo ottimale dei lati della vite, eliminando il rischio di una verifica errata causata da un blocco del diametro esterno del calibro.

SISTEMA MODULARE

Una vite di accoppiamento consente di collegare il calibro GO alla sezione NO-GO come richiesto. La scatola rigida protegge i calibri durante il trasporto. Il suo interno stampato mantiene il prodotto pulito e lo protegge dagli urti.

LE CERTIFICAT DE MESURE SCS



Un certificat est une confirmation écrite attestant de la qualité de l'équipement métrologique de l'entreprise. DC NANO TOOLS SA (Accréditation SCS 0143), membre du Groupe DC SWISS, vous propose le contrôle et l'étalonnage des jauges filetées selon la norme internationale standardisée ISO 17025.

Ce service payant est proposé dans les dimensions allant du diamètre 0.1 à 3.0 mm pour la mesure du diamètre sur flanc et de 0.1 à 3.5 mm pour le diamètre extérieur.

Toutes les jauges tampons sont certifiées SCS.

Accrédité ISO 17025:2017 © DC NANO TOOLS SA

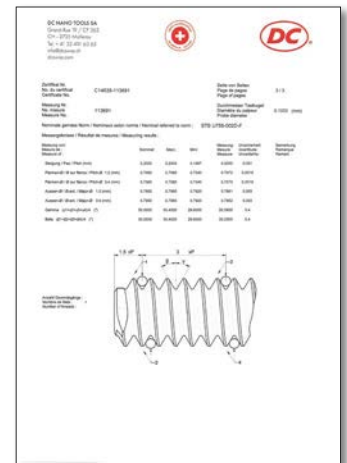

CERTIFICATO DI MISURA SCS



Un certificato è una conferma scritta della qualità delle apparecchiature metrologiche di un'azienda. DC NANO TOOLS SA (accreditamento SCS 0143), membro del Gruppo DC SWISS, può ispezionare e calibrare per voi i tamponi di controllo delle filettature secondo la norma internazionale ISO 17025.

Questo servizio a pagamento è disponibile per diametri di passo da 0.1 a 3.0 mm e per diametri esterni da 0.1 a 3.5 mm.

Tutti i tamponi filettati sono certificati SCS.

Accreditati ISO 17025:2017 © DC NANO TOOLS SA

TÉLÉCHARGEZ VOTRE ATTESTATION DE CONFORMITÉ

Désormais, retrouvez votre attestation de conformité n'importe où directement depuis votre téléphone. Il vous suffit de scanner le QR Code de la carte se trouvant à l'intérieur de la boîte et de télécharger le PDF joint.

L'attestation de conformité accompagnant chaque boîte confirme que la production a scrupuleusement suivi le processus de contrôle au terme de la fabrication.

Contrôle qualité DC SWISS SA

SCARICA LA VOSTRA CONFERMA DI CONFORMITÀ

Ora potete accedere alla vostra conferma di conformità in qualsiasi momento, in qualsiasi posto del vostro telefono. Basta scansionare il codice QR sulla scheda all'interno della scatola e scaricare il file pdf associato.

La conferma di conformità che accompagna ogni scatola conferma che la fabbrica ha seguito scrupolosamente il processo di monitoraggio post-produzione.

Controllo qualità DC SWISS SA

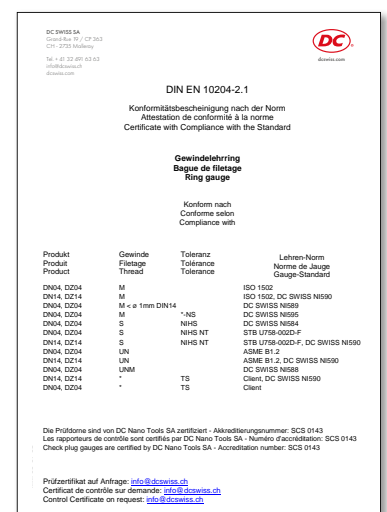
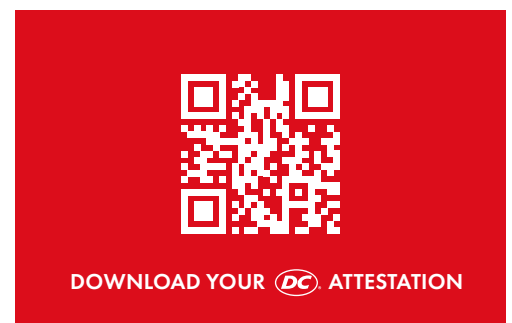

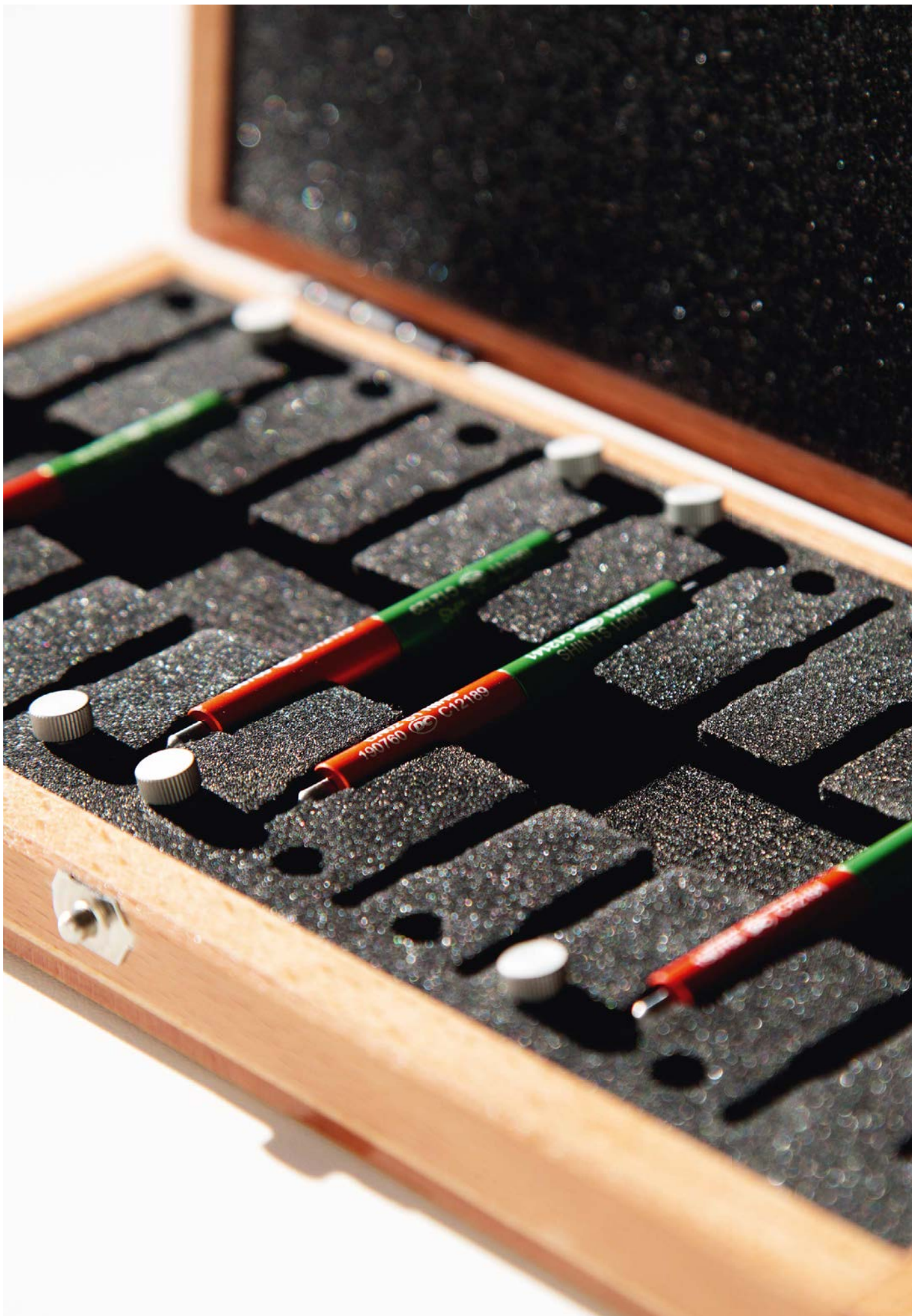

LES SETS DISPONIBLES — SET DISPONIBILI



**Jauges tampons et bagues DN
Calibri a tampone e anelli filettati DN**

SET UNITAIRE — SINGOLO SET



**Jauges bagues DZ
Anelli filettati DZ**

SET UNITAIRE — SINGOLO SET



**Jauges tampons DN / bagues DN
Calibri a tampone DN / anelli filettati DN**

**SET DE 10 OU 20 PIÈCES
SET DA 10 O 20 PEZZI**

*Pour chaque set, vous pouvez sélectionner
le nombre exact de jauges GO / NO-GO.*

Contactez-nous pour toute autre composition de set.

*È possibile selezionare il numero esatto di calibri
filettati di controllo GO / NO-GO per ogni set.*

Contattateci per qualsiasi altra composizione di set.

dcswiss.com / info@dcswiss.ch / +41 32 491 63 63

COMMANDE DE JAUGES NANO – ORDINE DEI CALIBRI FILETTATI NANO

TYPE D'OUTIL – TIPO DI STRUMENTO







CARACTÉRISTIQUES – CARATTERISTICHE

DIMENSION DIMENSIONE	TOLÉRANCE TOLLERANZA	NORME NORMA	QUANTITÉ QUANTITÀ	SPÉCIFIQUE SPECIFICHE

REMARQUES – NOTE

INFORMATIONS D'EXPÉDITION – INFORMAZIONI SULLA CONSEGNA

Merci de viser votre commande.
Grazie per firmare l'ordine.





Répertoire — Jauges de contrôle NANO pour la micromécanique et l'horlogerie

Rubrica — Calibri filettati NANO per micromeccanica e orologeria

	Jauges tampons de filetage Calibri a tampone filettati			Jauges bagues de filetage Anelli filettati				Tampons rapporteurs Tamponi di controllo a spina			
Caractéristiques Caratteristiche											
Type Tipo	DN01 GO	DN01 GO	DN02 NO-GO	DZ04 GO	DZ14 NO-GO	DN04 GO	DN14 NO-GO	RN05-1 GO	RN15-1 GO	RN05-2 NO-GO	RN15-2 NO-GO
M 4H / 5h	ISO DIN 14	382	382	383	383	384	384	399	399	400	400
M 6H / 6g	ISO DIN 13	382	382	383	383	384	384	399	399	400	400
M 5H / 6h	ISO DIN 13	382	382	383	383	384	384	399	399	400	400
MF 4H / 4h	ISO DIN 13	385	385	386	386	387	387	402	402	403	403
MF 6H / 6g	ISO DIN 13	385	385	386	386	387	387	402	402	403	403
MF 6h	ISO DIN 13			386	386	387	387	402	402	403	403
UNC 2B / 2A	ASME B1.1	388	388	389	389	390	390	405	405	406	406
UNC 3B / 3A	ASME B1.1	388	388	389	389	390	390	405	405	406	406
UNF 2B / 2A	ASME B1.1	388	388	389	389	390	390	405	405	406	406
UNF 3B / 3A	ASME B1.1	388	388	389	389	390	390	405	405	406	406
S NIHS 3G	NIHS	391									
S NIHS 4H	NIHS	391									
S NIHS 4H / 3G	NIHS		391								
S NIHS	NIHS			393	393	394	394	407	407	408	408
S NIHS NT	NIHS	392	392	393	393	394	394	407	407	408	408
SF NIHS 3G	NIHS	395									
SF NIHS 4H	NIHS	395									
SF NIHS 4H / 3G	NIHS		395								
SF NIHS	NIHS			396	396	397	397	409	409	410	410
SF NIHS NT	NIHS							409	409	410	410
SL	SL 15-01	398	398								

Répertoire — Jauges de contrôle NANO pour la micromécanique et l'horlogerie

Rubrica — Calibri filettati NANO per micromeccanica e orologeria

	Témoins d'usure Testimone di usura		Jauges étalons filettées Campioni filettati
Caractéristiques Caratteristiche			
			
Type Tipo	RN05-3	RN15-3	EN00
M 4H / 5h	ISO DIN 14 ISO DIN 13		
M 6H / 6g	ISO DIN 14 ISO DIN 13	401	401
M 5H / 6h	ISO DIN 13	401	401
MF 4H / 4h	ISO DIN 13	404	404
MF 6H / 6g	ISO DIN 13	404	404
MF 6h	ISO DIN 13	404	404
S NIHS	NIHS		411

Pictogrammes - Simboli



"Entre"

"Passa"



"N'entre pas"

"Non passa"



Tolérance 6H, "Entre"

Tolleranza 6H, "Passa"



Tolérance 6g, "N'entre pas"

Tolleranza 6g, "Non passa"



La longueur de mesure maximale l2 ne doit pas être dépassée

La lunghezza di misura massima l2 non deve essere superata



Phynox KL

Phynox KL



Sur demande, toutes les jauges de filetage sont également livrables pour les filetages à gauche

Tutti i calibri filettati possono essere forniti su richiesta con filettatura sinistra

Utilisation — Utilizzazione

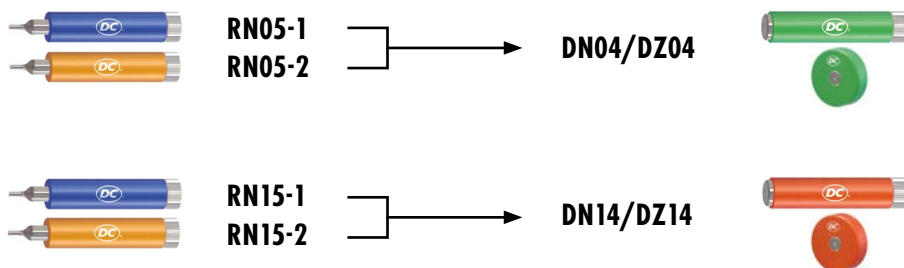

nano

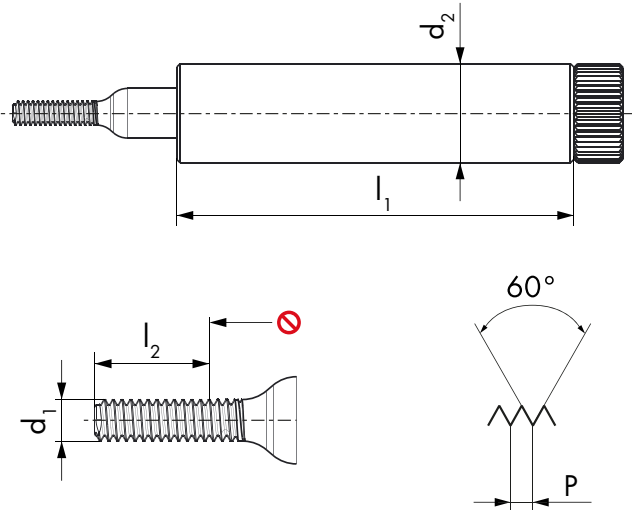

DN01 GO

DN02 NO-GO

DN01 GO

DN02 NO-GO



4H

4H

5H

5H

$\emptyset d_1$ M	P mm	l_1 mm	l_2 GO mm	d_2 mm	ID	ID	ID	ID
0.3	0.08	24	0.9	6	● 192778	● 192786		
0.35	0.09	24	1.05	6	● 192779	● 192787		
0.4	0.1	24	1.2	6	● 192780	● 192788		
0.5	0.125	24	1.5	6	● 192781	● 192789		
0.6	0.15	24	1.8	6	● 192782	● 192790		
0.7	0.175	24	2.1	6	● 192783	● 192791		
0.8	0.2	24	2.4	6	● 192784	● 192792		
0.9	0.225	24	2.7	6	● 192785	● 192793		
1	0.25	24	3	6	● 191113	● 191127	● 191421	● 191424
1.2	0.25	24	3.6	6	● 191114	● 191128	● 191422	● 191425
1.4	0.3	24	4.2	6	● 191115	● 191129	● 191423	● 191426

6H

6H

$\emptyset d_1$ M	P mm	l_1 mm	l_2 GO mm	d_2 mm	ID	ID
1.6	0.35	24	4.5	6	● 191427	● 191433
1.8	0.35	24	4.5	6	● 191428	● 191434
2	0.4	24	4.5	6	● 191429	● 191435
2.3	0.4	24	4.5	6	● 191430	● 191436
2.5	0.45	24	4.5	6	● 191431	● 191437
2.6	0.45	24	4.5	6	● 191432	● 191438



All nano thread plug gauges are SCS-certified and the paid certificate is available on request.



nano

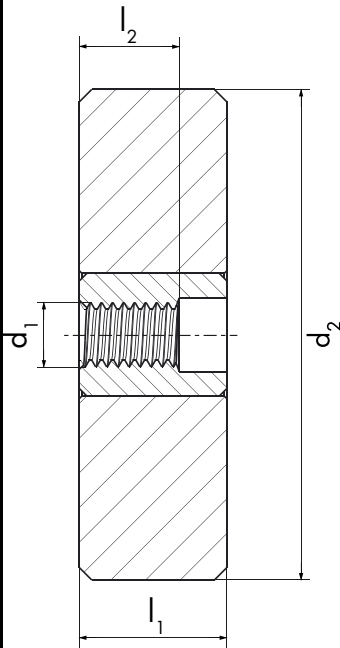

DZ04 GO

DZ14 NO-GO

DZ04 GO

DZ14 NO-GO



$\emptyset d_1$ M	P mm	l_1 mm	l_2 GO mm	d_2 mm	ID	ID	ID	ID
* 0.3	0.08	6	0.45	20	● 192842	● 192850		
* 0.35	0.09	6	0.53	20	● 192843	● 192851		
0.4	0.1	6	0.6	20	● 192844	● 192852		
0.5	0.125	6	0.75	20	● 192845	● 192853		
0.6	0.15	6	0.9	20	● 192846	● 192854		
0.7	0.175	6	1.05	20	● 192847	● 192855		
0.8	0.2	6	1.2	20	● 192848	● 192856		
0.9	0.225	6	1.35	20	● 192849	● 192857		
1	0.25	6	1.5	20			● 191473	● 191476
1.2	0.25	6	1.8	20			● 191474	● 191477
1.4	0.3	6	2.1	20			● 191475	● 191478
* In development								



$\emptyset d_1$ M	P mm	l_1 mm	l_2 GO mm	d_2 mm	ID	ID
1.6	0.35	6	2.4	20	● 191479	● 191485
1.8	0.35	6	2.7	20	● 191480	● 191486
2	0.4	6	3	20	● 191481	● 191487
2.3	0.4	6	3.45	20	● 191482	● 191488
2.5	0.45	6	3.75	20	● 191483	● 191489
2.6	0.45	6	3.9	20	● 191484	● 191490



All nano ring gauges have a certificate of measurement, established with SCS certified plug check gauges. The paid certificate is available on request.



nano

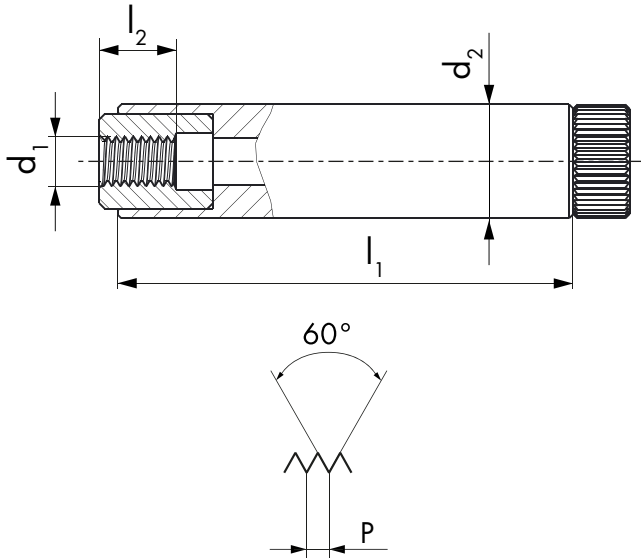

DN04 GO DN14 NO-GO DN04 GO DN14 NO-GO



$\emptyset d_1$ M	P mm	l_1 mm	l_2 GO mm	d_2 mm	ID	ID	ID	ID
* 0.3	0.08	24	0.45	6	● 192800	● 192808		
* 0.35	0.09	24	0.53	6	● 192801	● 192809		
0.4	0.1	24	0.6	6	● 192802	● 192810		
0.5	0.125	24	0.75	6	● 192803	● 192811		
0.6	0.15	24	0.9	6	● 192804	● 192812		
0.7	0.175	24	1.05	6	● 192805	● 192813		
0.8	0.2	24	1.2	6	● 192806	● 192814		
0.9	0.225	24	1.35	6	● 192807	● 192815		
1	0.25	24	1.5	6			● 191447	● 191450
1.2	0.25	24	1.8	6			● 191448	● 191451
1.4	0.3	24	2.1	6			● 191449	● 191452

* In development



$\emptyset d_1$ M	P mm	l_1 mm	l_2 GO mm	d_2 mm	ID	ID
1.6	0.35	24	2.4	6	● 191453	● 191459
1.8	0.35	24	2.7	6	● 191454	● 191460
2	0.4	24	3	6	● 191455	● 191461
2.3	0.4	24	3.45	6	● 191456	● 191462
2.5	0.45	24	3.75	6	● 191457	● 191463
2.6	0.45	24	3.9	6	● 191458	● 191464



All nano ring gauges have a certificate of measurement, established with SCS certified plug check gauges. The paid certificate is available on request.

nano

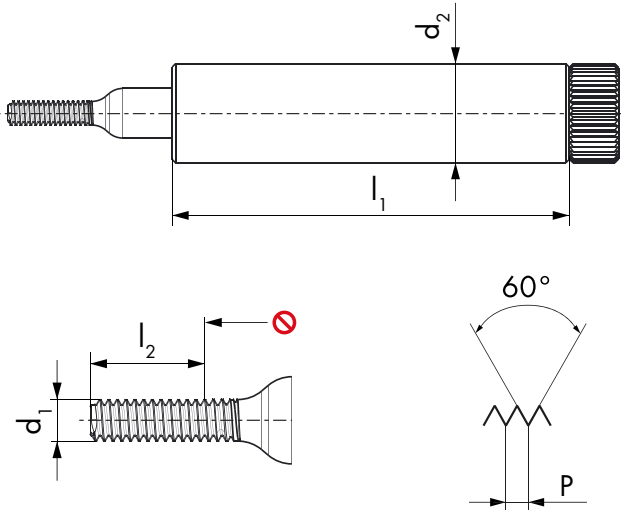

DN01 GO

DN02 NO-GO

DN01 GO

DN02 NO-GO



4H

4H

6H

6H

$\varnothing d_1$ MF	P mm	l_1 mm	l_2 GO mm	d_2 mm	ID	ID	ID	ID
1.4	0.2	24	4.2	6	● 191116	● 191130		
1.6	0.2	24	3	6	● 191117	● 191131		
1.8	0.2	24	3	6	● 191118	● 191132		
2	0.2	24	3	6	● 191119	● 191133		
2	0.25	24	3	6	● 192794	● 192797		
2.2	0.2	24	3	6	● 191120	● 191134		
2.2	0.25	24	3	6	● 191121	● 191135		
2.3	0.2	24	3	6	● 191122	● 191136		
2.3	0.25	24	3	6	● 191123	● 191137		
2.5	0.2	24	3	6	● 191124	● 191138		
2.5	0.25	24	3	6	● 191125	● 191139		
2.5	0.35	24	4.5	6			● 192795	● 192798
2.6	0.35	24	4.5	6			● 192796	● 192799



All nano thread plug gauges are SCS-certified and the paid certificate is available on request.

nano

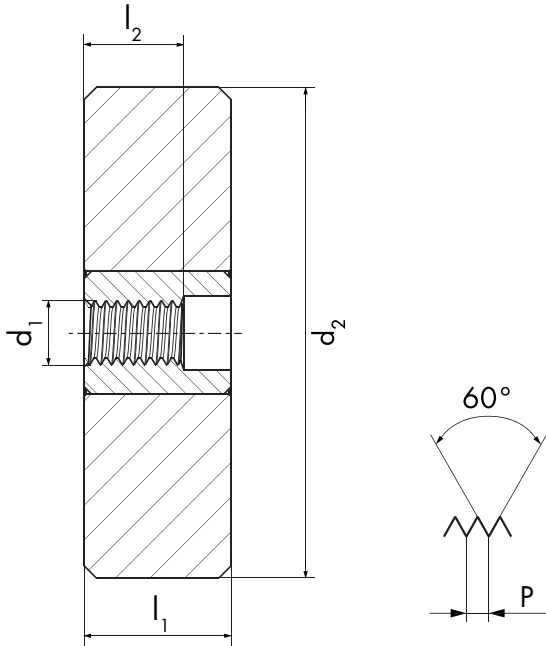

DZ04 GO

DZ14 NO-GO

DZ04 GO

DZ14 NO-GO



4h

4h

6g

6g

$\emptyset d_1$ MF	P mm	l_1 mm	l_2 GO mm	d_2 mm	ID	ID	ID	ID
1.4	0.2	6	2.1	20	● 194887	● 194888	● 192858 ¹	● 192871 ¹
1.6	0.2	6	1.8	20	● 191201	● 191215	● 191229	● 191243
1.8	0.2	6	1.8	20	● 191202	● 191216	● 191230	● 191244
2	0.2	6	1.8	20	● 190711	● 190710	● 191231	● 191245
2	0.25	6	2.25	20	● 194872	● 190690	● 194876	● 194877
2.2	0.2	6	1.8	20	● 191204	● 191218	● 191232	● 191246
2.2	0.25	6	2.25	20	● 191205	● 191219	● 191233	● 191247
2.3	0.2	6	1.8	20	● 191206	● 191220	● 191234	● 191248
2.3	0.25	6	2.25	20	● 191207	● 191221	● 191235	● 191249
2.5	0.2	6	1.8	20	● 191208	● 191222	● 191236	● 191250
2.5	0.25	6	2.25	20	● 194873	● 191223	● 191237	● 191251
2.5	0.35	6	3.75	20			● 192869	● 192882
2.6	0.35	6	3.9	20			● 192870	● 192883

¹ Tol. 6h



All nano ring gauges have a certificate of measurement, established with SCS certified plug check gauges. The paid certificate is available on request.

nano

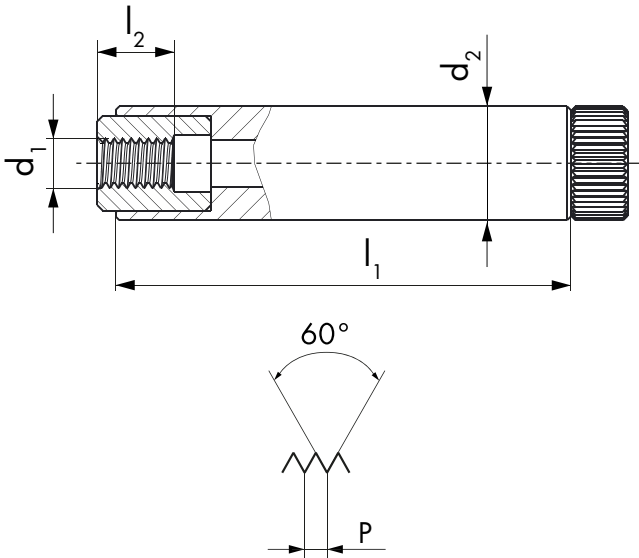

DN04 GO

DN14 NO-GO

DN04 GO

DN14 NO-GO



Ø d ₁ MF	P mm	l ₁ mm	l ₂ GO mm	d ₂ mm	ID	ID	ID	ID
1.4	0.2	24	2.1	6	● 194885	● 194886	● 192816 ¹	● 192829 ¹
1.6	0.2	24	1.8	6	● 191145	● 191159	● 191173	● 191187
1.8	0.2	24	1.8	6	● 191146	● 191160	● 191174	● 191188
2	0.2	24	1.8	6	● 191147	● 191161	● 191175	● 191189
2	0.25	24	2.25	6	● 194870	● 194871	● 194874	● 194875
2.2	0.2	24	1.8	6	● 191148	● 191162	● 191176	● 191190
2.2	0.25	24	2.25	6	● 191149	● 191163	● 191177	● 191191
2.3	0.2	24	1.8	6	● 191150	● 191164	● 191178	● 191192
2.3	0.25	24	2.25	6	● 191151	● 191165	● 191179	● 191193
2.5	0.2	24	1.8	6	● 191152	● 191166	● 191180	● 191194
2.5	0.25	24	2.25	6	● 191153	● 191167	● 191181	● 191195
2.5	0.35	24	3.75	6			● 192827	● 192840
2.6	0.35	24	3.9	6			● 192828	● 192841

¹ Tol. 6h



All nano ring gauges have a certificate of measurement, established with SCS certified plug check gauges. The paid certificate is available on request.

UNC, UNF ASME B1.1 ASME B1.2

VHM
CAR

nano

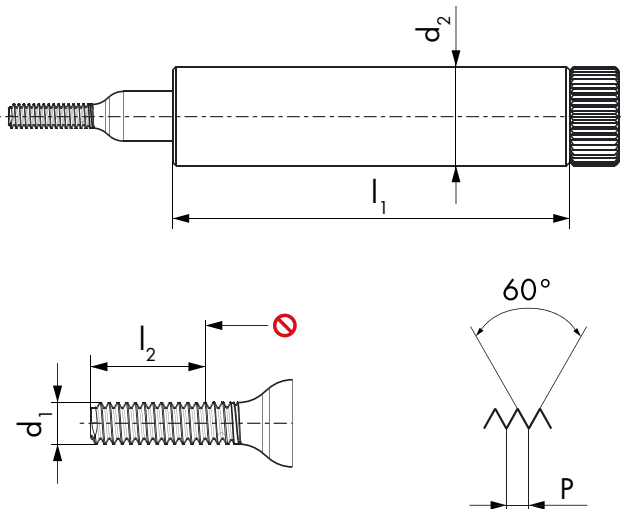

DN01 GO

DN02 NO-GO

DN01 GO

DN02 NO-GO



2B

2B

3B

3B

$\emptyset d_1$ UNC	P TPI	$\emptyset d_1$ mm	l_1 mm	l_2 GO mm	d_2 mm	ID	ID	ID	ID
1	64	1.854	24	6.35	6	● 191577	● 191580	● 191583	● 191586
2	54	2.184	24	6.35	6	● 191578	● 191581	● 191584	● 191587
3	48	2.515	24	6.35	6	● 191579	● 191582	● 191585	● 191588
$\emptyset d_1$ UNF	P TPI	$\emptyset d_1$ mm	l_1 mm	l_2 GO mm	d_2 mm	ID	ID	ID	ID
0	80	1.524	24	4.76	6	● 191637	● 191641	● 191645	● 191649
1	72	1.854	24	4.76	6	● 191638	● 191642	● 191646	● 191650
2	64	2.184	24	4.76	6	● 191639	● 191643	● 191647	● 191651
3	56	2.515	24	4.76	6	● 191640	● 191644	● 191648	● 191652



All nano thread plug gauges are SCS-certified and the paid certificate is available on request.

UNC, UNF

ASME B1.1

DZ04: ASME B1.2 / DZ14: ASME B1.2, DC SWISS NI590

PHYN.
KL

nano

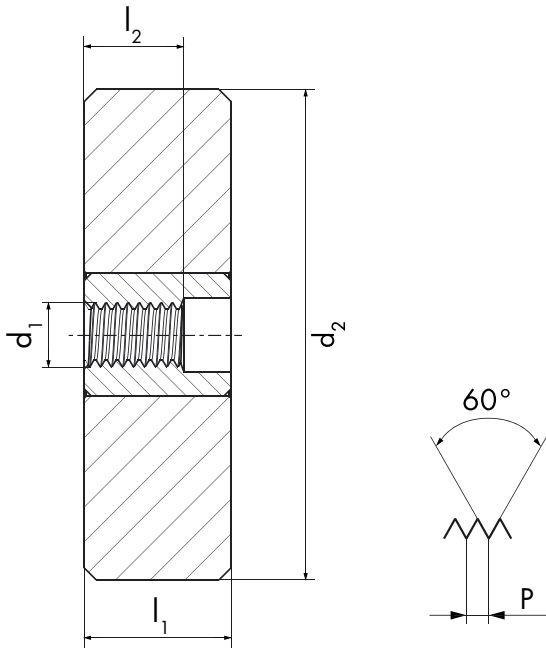

DZ04 GO

DZ14 NO-GO

DZ04 GO

DZ14 NO-GO



2A

2A

3A

3A

$\emptyset d_1$ UNC	P TPI	$\emptyset d_1$ mm	l_1 mm	l_2 GO mm	d_2 mm	ID	ID	ID	ID
1	64	1.854	6	2.78	20	● 191601	● 191604	● 191607	● 191610
2	56	2.184	6	3.28	20	● 191602	● 191605	● 191608	● 191611
3	48	2.515	6	3.77	20	● 191603	● 191606	● 191609	● 191612
$\emptyset d_1$ UNF	P TPI	$\emptyset d_1$ mm	l_1 mm	l_2 GO mm	d_2 mm	ID	ID	ID	ID
0	80	1.524	6	2.29	20	● 191669	● 191673	● 191677	● 191681
1	72	1.854	6	2.78	20	● 191670	● 191674	● 191678	● 191682
2	64	2.184	6	3.28	20	● 191671	● 191675	● 191679	● 191683
3	56	2.515	6	3.77	20	● 191672	● 191676	● 191680	● 191684



All nano ring gauges have a certificate of measurement, established with SCS certified plug check gauges. The paid certificate is available on request.

UNC, UNF

ASME B1.1

DN04: ASME B1.2 / DN14: ASME B1.2, DC SWISS NI590

PHYN.
KL

nano

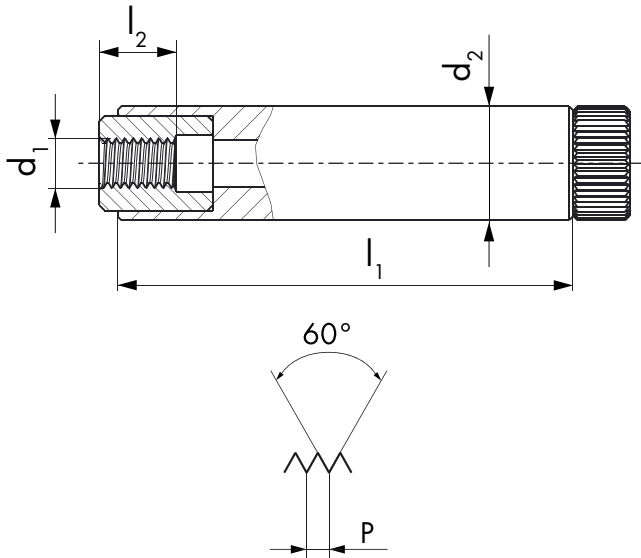

DN04 GO

DN14 NO-GO

DN04 GO

DN14 NO-GO



$\emptyset d_1$ UNC	P TPI	$\emptyset d_1$ mm	l_1 mm	l_2 GO mm	d_2 mm	ID	ID	ID	ID
1	64	1.854	24	2.78	6	● 191589	● 191592	● 191595	● 191598
2	56	2.184	24	3.28	6	● 191590	● 191593	● 191596	● 191599
3	48	2.515	24	3.77	6	● 191591	● 191594	● 191597	● 191600
$\emptyset d_1$ UNF	P TPI	$\emptyset d_1$ mm	l_1 mm	l_2 GO mm	d_2 mm	ID	ID	ID	ID
0	80	1.524	24	2.29	6	● 191653	● 191657	● 191661	● 191665
1	72	1.854	24	2.78	6	● 191654	● 191658	● 191662	● 191666
2	64	2.184	24	3.28	6	● 191655	● 191659	● 191663	● 191667
3	56	2.515	24	3.77	6	● 191656	● 191660	● 191664	● 191668



All nano ring gauges have a certificate of measurement, established with SCS certified plug check gauges. The paid certificate is available on request.

nano

DN01 GO

DN01 GO

DN02 NO-GO

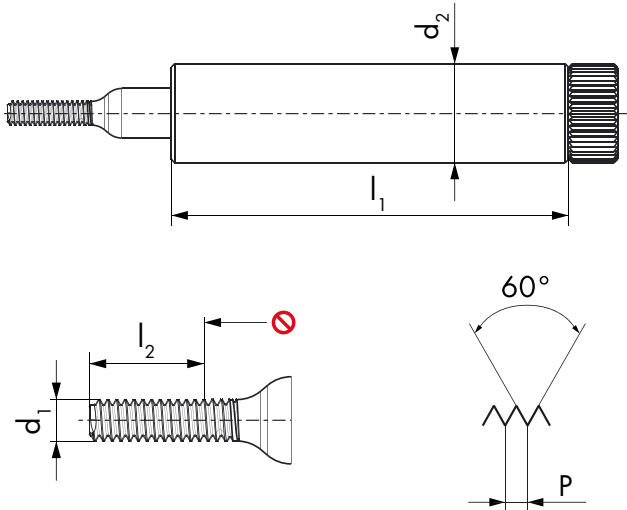

$\emptyset d_1$ S	P mm	l_1 mm	l_2 GO mm	d_2 mm	ID	ID	ID
0.3	0.08	24	0.9	6	● 190733	● 193242	● 190752
0.35	0.09	24	1.05	6	● 190734	● 193243	● 190753
0.4	0.1	24	1.2	6	● 190735	● 193244	● 190754
0.5	0.125	24	1.5	6	● 190736	● 193245	● 190755
0.6	0.15	24	1.8	6	● 190737	● 193246	● 190756
0.7	0.175	24	2.1	6	● 190738	● 193247	● 190757
0.8	0.2	24	2.4	6	● 190739	● 193248	● 190758
0.9	0.225	24	2.7	6	● 190740	● 193249	● 190759
1	0.25	24	3	6	● 190741	● 193250	● 190760
1.2	0.25	24	3.6	6	● 190742	● 193251	● 190761
1.4	0.3	24	4.2	6	● 190743	● 193252	● 190762



All nano thread plug gauges are SCS-certified and the paid certificate is available on request.

nano

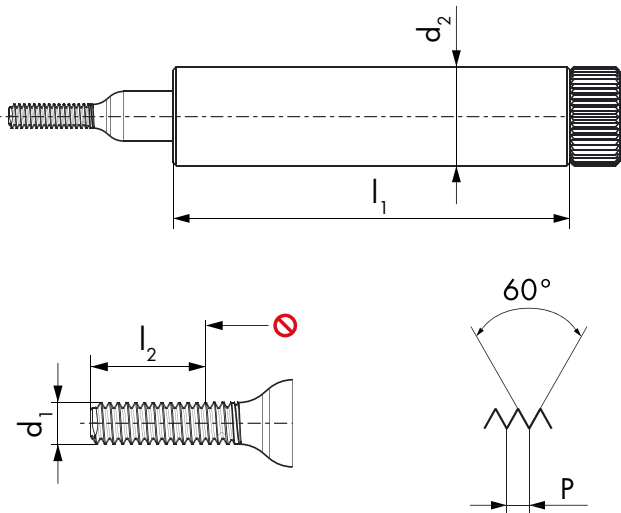

DN01 GO

DN02 NO-GO



$\emptyset d_1$ S	P mm	l_1 mm	l_2 GO mm	d_2 mm	ID	ID
0.3	0.08	24	0.9	6	● 190771	● 190790
0.35	0.09	24	1.05	6	● 190772	● 190791
0.4	0.1	24	1.2	6	● 190773	● 190792
0.5	0.125	24	1.5	6	● 190774	● 190793
0.6	0.15	24	1.8	6	● 190775	● 190794
0.7	0.175	24	2.1	6	● 190776	● 190795
0.8	0.2	24	2.4	6	● 190777	● 190796
0.9	0.225	24	2.7	6	● 190778	● 190797
1	0.25	24	3	6	● 190779	● 190798
1.2	0.25	24	3.6	6	● 190780	● 190799
1.4	0.3	24	4.2	6	● 190781	● 190800



All nano thread plug gauges are SCS-certified and the paid certificate is available on request.



nano

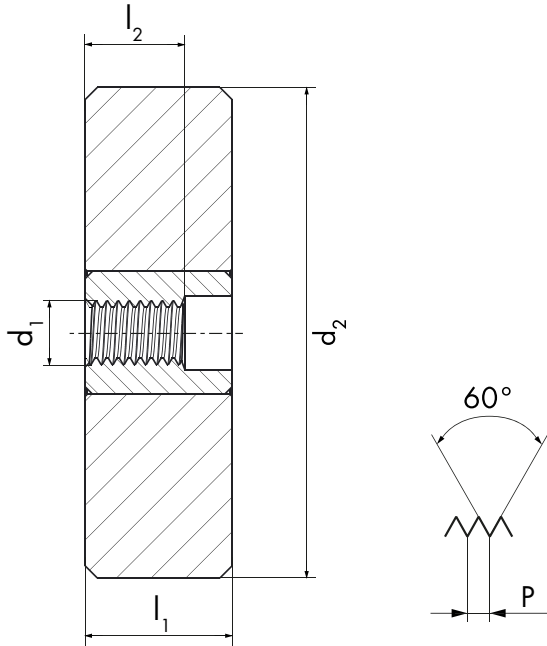

DZ04 GO

DZ14 NO-GO

DZ04 GO

DZ14 NO-GO



$\emptyset d_1$ S	P mm	l_1 mm	l_2 GO mm	d_2 mm	ID	ID	ID	ID
* 0.3	0.08	6	0.45	20	● 190809	● 190828	● 190847	● 190866
* 0.35	0.09	6	0.53	20	● 190810	● 190829	● 190848	● 190867
0.4	0.1	6	0.6	20	● 190811	● 190830	● 190849	● 190868
0.5	0.125	6	0.75	20	● 190812	● 190831	● 190850	● 190869
0.6	0.15	6	0.9	20	● 190813	● 190832	● 190851	● 190870
0.7	0.175	6	1.05	20	● 190814	● 190833	● 190852	● 190871
0.8	0.2	6	1.2	20	● 190815	● 190834	● 190853	● 190872
0.9	0.225	6	1.35	20	● 190816	● 190835	● 190854	● 190873
1	0.25	6	1.5	20	● 190817	● 190836	● 190855	● 190874
1.2	0.25	6	1.8	20	● 190818	● 190837	● 190856	● 190875
1.4	0.3	6	2.1	20	● 190819	● 190838	● 190857	● 190876

* In development



All nano ring gauges have a certificate of measurement, established with SCS certified plug check gauges. The paid certificate is available on request.

nano

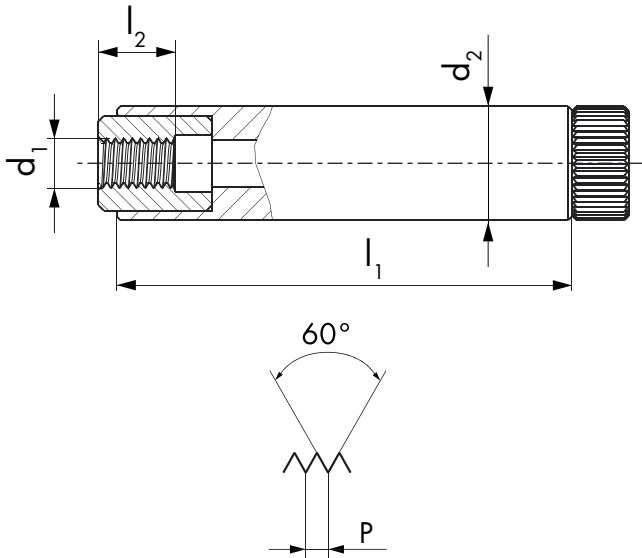

DN04 GO DN14 NO-GO DN04 GO DN14 NO-GO



$\emptyset d_1$ S	P mm	l_1 mm	l_2 GO mm	d_2 mm	ID	ID	ID	ID
* 0.3	0.08	24	0.45	6	● 190885	● 190904	● 190923	● 190942
* 0.35	0.09	24	0.53	6	● 190886	● 190905	● 190924	● 190943
0.4	0.1	24	0.6	6	● 190887	● 190906	● 190925	● 190944
0.5	0.125	24	0.75	6	● 190888	● 190907	● 190926	● 190945
0.6	0.15	24	0.9	6	● 190889	● 190908	● 190927	● 190946
0.7	0.175	24	1.05	6	● 190890	● 190909	● 190928	● 190947
0.8	0.2	24	1.2	6	● 190891	● 190910	● 190929	● 190948
0.9	0.225	24	1.35	6	● 190892	● 190911	● 190930	● 190949
1	0.25	24	1.5	6	● 190893	● 190912	● 190931	● 190950
1.2	0.25	24	1.8	6	● 190894	● 190913	● 190932	● 190951
1.4	0.3	24	2.1	6	● 190895	● 190914	● 190933	● 190952

*In development



All nano ring gauges have a certificate of measurement, established with SCS certified plug check gauges. The paid certificate is available on request.

nano

DN01 GO

DN01 GO

DN02 NO-GO

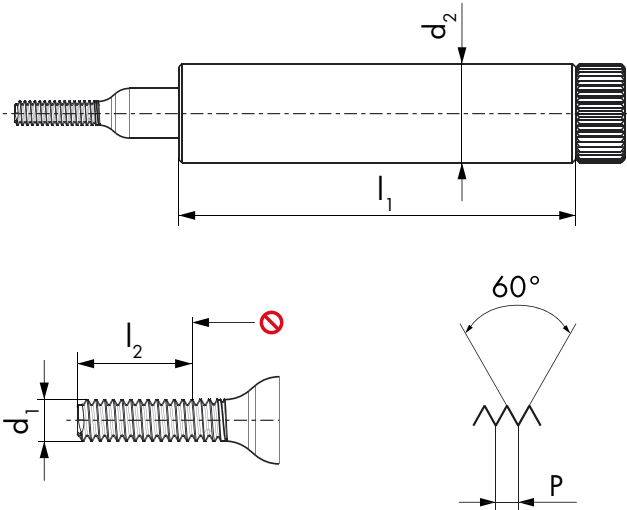

$\emptyset d_1$ SF	P mm	l_1 mm	l_2 GO mm	d_2 mm	ID	ID	ID
1.4	0.2	24	4.2	6	● 190744	● 193256	● 190763
1.6	0.2	24	3	6	● 190745	● 193257	● 190764
1.8	0.2	24	3	6	● 190746	● 193258	● 190765
2	0.2	24	3	6	● 190747	● 193259	● 190766
2.2	0.2	24	3	6	● 190748	● 193260	● 190767
2.2	0.25	24	3	6	● 190749	● 193261	● 190768
2.5	0.2	24	3	6	● 190750	● 193262	● 190769
2.5	0.25	24	3	6	● 190751	● 193263	● 190770



All nano thread plug gauges are SCS-certified and the paid certificate is available on request.

nano

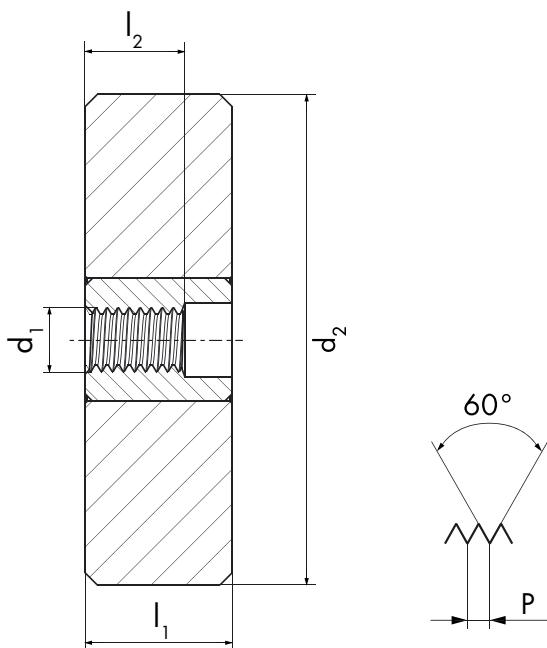

DZ04 GO

DZ14 NO-GO



$\emptyset d_1$ SF	P mm	l_1 mm	l_2 GO mm	d_2 mm	ID	ID
1.4	0.2	6	2.1	20	● 190820	● 190839
1.6	0.2	6	1.8	20	● 190821	● 190840
1.8	0.2	6	1.8	20	● 190822	● 190841
2	0.2	6	1.8	20	● 190823	● 190842
2.2	0.2	6	1.8	20	● 190824	● 190843
2.2	0.25	6	2.25	20	● 190825	● 190844
2.5	0.2	6	1.8	20	● 190826	● 190845
2.5	0.25	6	2.25	20	● 190827	● 190846



All nano ring gauges have a certificate of measurement, established with SCS certified plug check gauges. The paid certificate is available on request.

nano

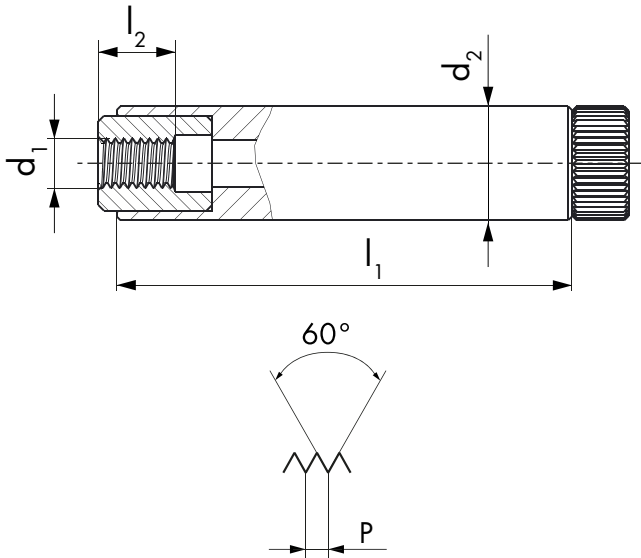

DN04 GO

DN14 NO-GO



$\emptyset d_1$ SF	P mm	l_1 mm	l_2 GO mm	d_2 mm	ID	ID
1.4	0.2	24	2.1	6	● 190896	● 190915
1.6	0.2	24	1.8	6	● 190897	● 190916
1.8	0.2	24	1.8	6	● 190898	● 190917
2	0.2	24	1.8	6	● 190899	● 190918
2.2	0.2	24	1.8	6	● 190900	● 190919
2.2	0.25	24	2.25	6	● 190901	● 190920
2.5	0.2	24	1.8	6	● 190902	● 190921
2.5	0.25	24	2.28	6	● 190903	● 190922



All nano ring gauges have a certificate of measurement, established with SCS certified plug check gauges. The paid certificate is available on request.

nano

DN01 GO

DN02 NO-GO

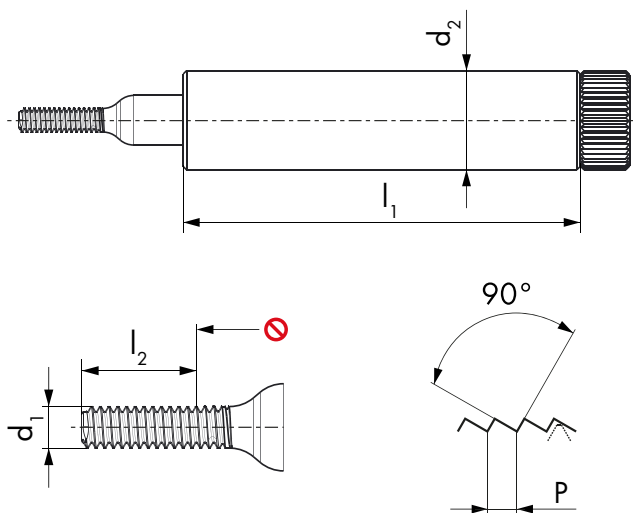

$\emptyset d_1$ SL	P mm	l_1 mm	l_2 GO mm	d_2 mm	ID	ID
0.5	0.1	24	1.5	6	● 600178	● 600186
0.6	0.125	24	1.8	6	● 600179	● 600187
0.7	0.15	24	2.1	6	● 600180	● 600188
0.8	0.15	24	2.4	6	● 600181	● 600189
0.9	0.175	24	2.7	6	● 600182	● 600190
1	0.2	24	3	6	● 600183	● 600191
1.2	0.2	24	3.6	6	● 600184	● 600192
1.4	0.25	24	4.2	6	● 600185	● 600193



All nano thread plug gauges are SCS-certified and the paid certificate is available on request.



ISO DIN 14 / ISO DIN 13
DC SWISS NI589 / ISO 1502



nano

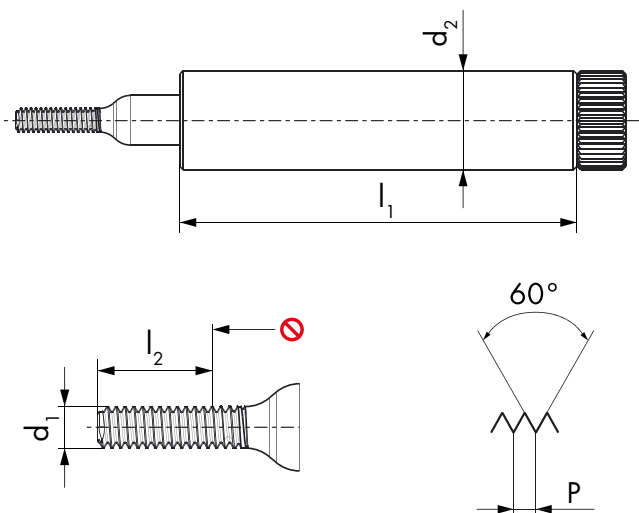

RN05-1 GO

RN15-1 GO

RN05-1 GO

RN15-1 GO



5h

5h

6h

6h

$\emptyset d_1$ M	P mm	l_1 mm	l_2 GO mm	d_2 mm	ID	ID	ID	ID
0.3	0.08	24	0.61	6	● 192884	● 192892		
0.35	0.09	24	0.71	6	● 192885	● 192893		
0.4	0.1	24	0.8	6	● 192886	● 192894		
0.5	0.125	24	1	6	● 192887	● 192895		
0.6	0.15	24	1.2	6	● 192888	● 192896		
0.7	0.175	24	1.4	6	● 192889	● 192897		
0.8	0.2	24	1.6	6	● 192890	● 192898		
0.9	0.225	24	1.8	6	● 192891	● 192899		
1	0.25	24	2	6			● 191499	● 191508
1.2	0.25	24	2.3	6			● 191500	● 191509
1.4	0.3	24	2.7	6			● 191501	● 191510

6g

6g

$\emptyset d_1$ M	P mm	l_1 mm	l_2 GO mm	d_2 mm	ID	ID
1.6	0.35	24	3.1	6	● 191517	● 191535
1.8	0.35	24	3.4	6	● 191518	● 191536
2	0.4	24	3.8	6	● 191519	● 191537
2.3	0.4	24	4.25	6	● 191520	● 191538
2.5	0.45	24	4.65	6	● 191521	● 191539
2.6	0.45	24	4.8	6	● 191522	● 191540



SCS certificate included.





ISO DIN 14 / ISO DIN 13
DC SWISS NI589 / ISO 1502



nano

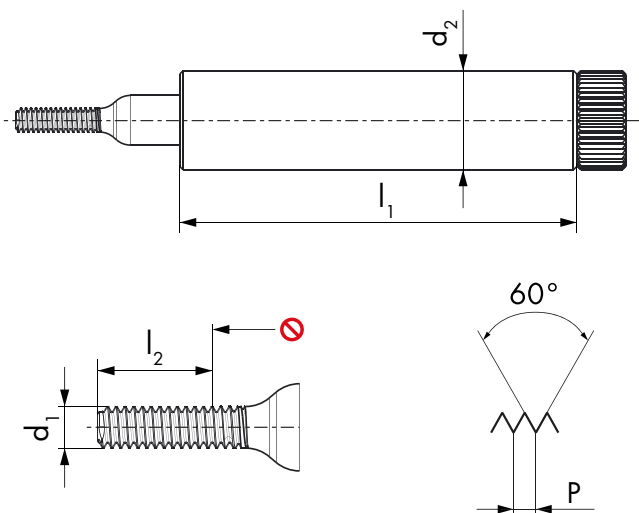

RN05-2
NO-GO

RN15-2
NO-GO

RN05-2
NO-GO

RN15-2
NO-GO



5h

5h

6h

6h

$\emptyset d_1$ M	P mm	l_1 mm	l_2 GO mm	d_2 mm
0.3	0.08	24	0.61	6
0.35	0.09	24	0.71	6
0.4	0.1	24	0.8	6
0.5	0.125	24	1	6
0.6	0.15	24	1.2	6
0.7	0.175	24	1.4	6
0.8	0.2	24	1.6	6
0.9	0.225	24	1.8	6
1	0.25	24	2	6
1.2	0.25	24	2.3	6
1.4	0.3	24	2.7	6

ID	ID	ID	ID
● 192900	● 192908		
● 192901	● 192909		
● 192902	● 192910		
● 192903	● 192911		
● 192904	● 192912		
● 192905	● 192913		
● 192906	● 192914		
● 192907	● 192915		
		● 191502	● 191511
		● 191503	● 191512
		● 191504	● 191513

6g

6g

$\emptyset d_1$ M	P mm	l_1 mm	l_2 GO mm	d_2 mm
1.6	0.35	24	3.1	6
1.8	0.35	24	3.4	6
2	0.4	24	3.8	6
2.3	0.4	24	4.25	6
2.5	0.45	24	4.65	6
2.6	0.45	24	4.8	6

ID	ID
● 191523	● 191541
● 191524	● 191542
● 191525	● 191543
● 191526	● 191544
● 191527	● 191545
● 191528	● 191546



SCS certificate included.



ISO DIN 13
ISO 1502

VHM
CAR

nano

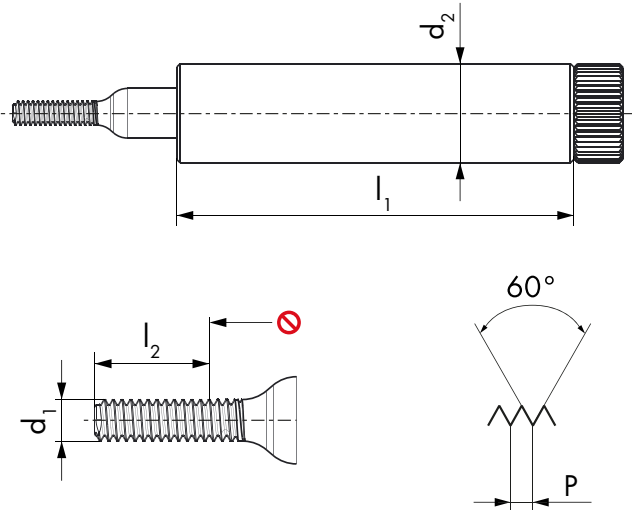

RN05-3
WEAR

RN15-3
WEAR

RN05-3
WEAR

RN15-3
WEAR



6h

6h

6g

6g

$\emptyset d_1$ M	P mm	l_1 mm	l_2 GO mm	d_2 mm	ID	ID	ID	ID
1	0.25	24	2	6	● 191505	● 191514		
1.2	0.25	24	2.3	6	● 191506	● 191515		
1.4	0.3	24	2.7	6	● 191507	● 191516		
1.6	0.35	24	3.1	6			● 191529	● 191547
1.8	0.35	24	3.4	6			● 191530	● 191548
2	0.4	24	3.8	6			● 191531	● 191549
2.3	0.4	24	4.25	6			● 191532	● 191550
2.5	0.45	24	4.65	6			● 191533	● 191551
2.6	0.45	24	4.8	6			● 191534	● 191552



SCS certificate included.



nano

RN05-1 GO

RN15-1 GO

RN05-1 GO

RN15-1 GO

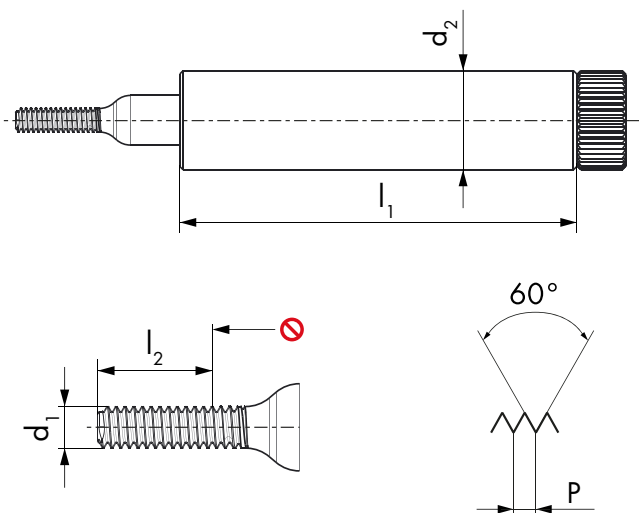

4h

4h

6h

6h

$\emptyset d_1$ MF	P mm	l_1 mm	l_2 GO mm	d_2 mm	ID	ID	ID	ID
1.4	0.2	24	2.5	6	● 191256	● 191298	● 192932	● 192945
1.6	0.2	24	2.2	6	● 195874	● 195876	● 192933	● 192946
1.8	0.2	24	2.2	6	● 197711	● 197712	● 192934	● 192947
2	0.2	24	2.2	6	● 197724	● 197725	● 192935	● 192948
2	0.25	24	2.75	6	● 197726	● 197727	● 192936	● 192949
2.2	0.2	24	2.2	6	● 197713	● 197714	● 192937	● 192950
2.2	0.25	24	2.75	6	● 197715	● 197716	● 192938	● 192951
2.3	0.2	24	2.2	6	● 197717	● 197718	● 192939	● 192952
2.3	0.25	24	2.75	6	● 197719	● 197720	● 192940	● 192953
2.5	0.2	24	2.2	6	● 197721	● 197722	● 192941	● 192954
2.5	0.25	24	2.75	6	● 190683	● 197723	● 192942	● 192955

6g

6g

$\emptyset d_1$ MF	P mm	l_1 mm	l_2 GO mm	d_2 mm	ID	ID
2.5	0.35	24	4.45	6	● 192943	● 192956
2.6	0.35	24	4.6	6	● 192944	● 192957



SCS certificate included.

nano

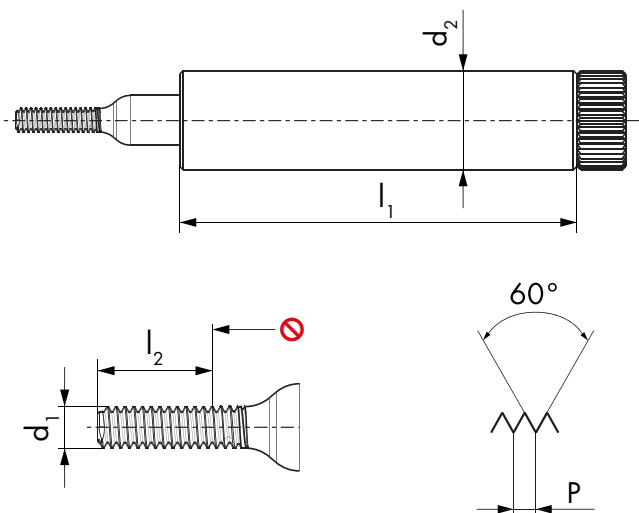

**RN05-2
NO-GO**

**RN15-2
NO-GO**

**RN05-2
NO-GO**

**RN15-2
NO-GO**



4h

4h

6h

6h

$\emptyset d_1$ MF	P mm	l_1 mm	l_2 GO mm	d_2 mm	ID	ID	ID	ID
1.4	0.2	24	2.5	6	● 191270	● 197728	● 192958	● 192971
1.6	0.2	24	1.6	6	● 195875	● 195877	● 192959	● 192972
1.8	0.2	24	1.6	6	● 197729	● 197730	● 192960	● 192973
2	0.2	24	1.6	6	● 199060	● 199061	● 192961	● 192974
2	0.25	24	2	6	● 199062	● 199063	● 192962	● 192975
2.2	0.2	24	1.6	6	● 197731	● 197732	● 192963	● 192976
2.2	0.25	24	2	6	● 197733	● 199364	● 192964	● 192977
2.3	0.2	24	1.6	6	● 199053	● 199054	● 192965	● 192978
2.3	0.25	24	2	6	● 199055	● 199056	● 192966	● 192979
2.5	0.2	24	1.6	6	● 199057	● 199058	● 192967	● 192980
2.5	0.25	24	2	6	● 190686	● 199059	● 192968	● 192981

6g

6g

$\emptyset d_1$ MF	P mm	l_1 mm	l_2 GO mm	d_2 mm	ID	ID
2.5	0.35	24	4.45	6	● 192969	● 192982
2.6	0.35	24	4.6	6	● 192970	● 192983



SCS certificate included.

nano

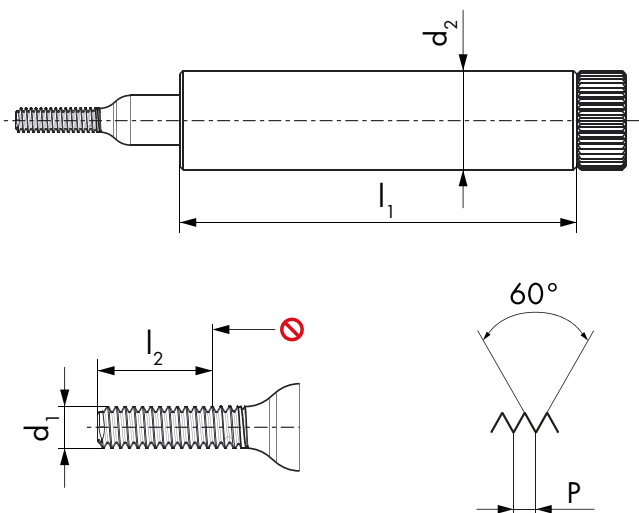

**RN05-3
WEAR**

**RN15-3
WEAR**

**RN05-3
WEAR**

**RN15-3
WEAR**



4h

4h

6h

6h

$\emptyset d_1$ MF	P mm	l_1 mm	l_2 G0 mm	d_2 mm	ID	ID	ID	ID
1.4	0.2	24	2.5	6	● 191284	● 191326	● 192984	● 192997
1.6	0.2	24	1.6	6	● 199064	● 199065	● 192985	● 192998
1.8	0.2	24	1.6	6	● 199066	● 199067	● 192986	● 192999
2	0.2	24	1.6	6	● 199360	● 199361	● 192987	● 193000
2	0.25	24	2	6	● 199362	● 199363	● 192988	● 193001
2.2	0.2	24	1.6	6	● 199068	● 199069	● 192989	● 193002
2.2	0.25	24	2	6	● 199070	● 199071	● 192990	● 193003
2.3	0.2	24	1.6	6	● 199072	● 199073	● 192991	● 193004
2.3	0.25	24	2	6	● 199074	● 199075	● 192992	● 193005
2.5	0.2	24	1.6	6	● 199076	● 199077	● 192993	● 193006
2.5	0.25	24	2	6	● 199358	● 199359	● 192994	● 193007

6g

6g

$\emptyset d_1$ MF	P mm	l_1 mm	l_2 G0 mm	d_2 mm	ID	ID
2.5	0.35	24	4.45	6	● 192995	● 193008
2.6	0.35	24	4.6	6	● 192996	● 193009



SCS certificate included.

UNC, UNF ASME B1.1 DC SWISS NI582

VHM
CAR

nano

RN05-1 GO

RN15-1 GO

RN05-1 GO

RN15-1 GO

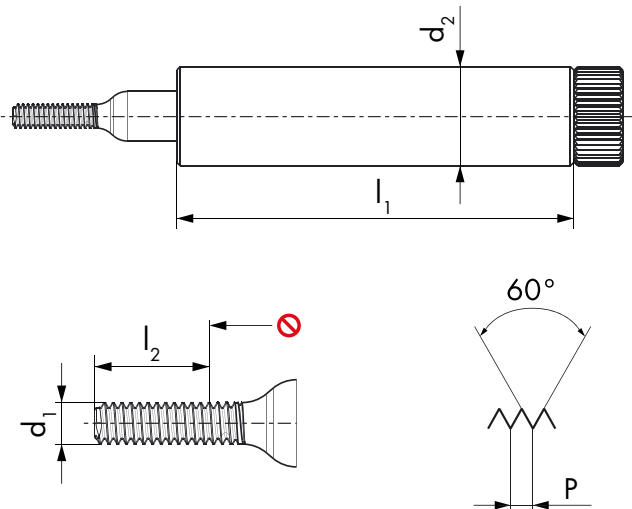

2A

2A

3A

3A

$\emptyset d_1$ UNC	P TPI	$\emptyset d_1$ mm	l_1 mm	l_2 GO mm	d_2 mm	ID	ID	ID	ID
1	64	1.854	24	3.58	6	● 191613	● 191619	● 191625	● 191631
2	56	2.184	24	4.18	6	● 191614	● 191620	● 191626	● 191632
3	48	2.515	24	4.83	6	● 191615	● 191621	● 191627	● 191633
$\emptyset d_1$ UNF	P TPI	$\emptyset d_1$ mm	l_1 mm	l_2 GO mm	d_2 mm	ID	ID	ID	ID
0	80	1.524	24	2.92	6	● 191685	● 191693	● 191701	● 191709
1	72	1.854	24	3.49	6	● 191686	● 191694	● 191702	● 191710
2	64	2.184	24	4.07	6	● 191687	● 191695	● 191703	● 191711
3	56	2.515	24	4.68	6	● 191688	● 191696	● 191704	● 191712



SCS certificate included.



UNC, UNF ASME B1.1 DC SWISS NI582

VHM
CAR

nano

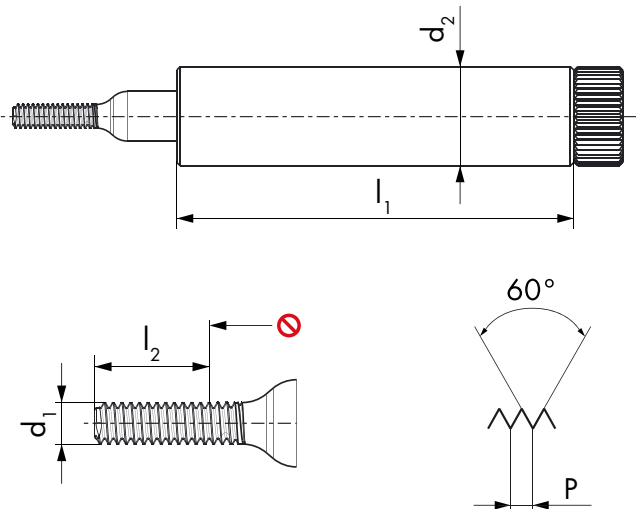

RN05-2
NO-GO

RN15-2
NO-GO

RN05-2
NO-GO

RN15-2
NO-GO



2A

2A

3A

3A

$\emptyset d_1$ UNC	P TPI	$\emptyset d_1$ mm	l_1 mm	l_2 GO mm	d_2 mm	ID	ID	ID	ID
1	64	1.854	24	3.58	6	● 191616	● 191622	● 191628	● 191634
2	56	2.184	24	4.18	6	● 191617	● 191623	● 191629	● 191635
3	48	2.515	24	4.83	6	● 191618	● 191624	● 191630	● 191636
$\emptyset d_1$ UNF	P TPI	$\emptyset d_1$ mm	l_1 mm	l_2 GO mm	d_2 mm	ID	ID	ID	ID
0	80	1.524	24	2.92	6	● 191689	● 191697	● 191705	● 191713
1	72	1.854	24	3.49	6	● 191690	● 191698	● 191706	● 191714
2	64	2.184	24	4.07	6	● 191691	● 191699	● 191707	● 191715
3	56	2.515	24	4.68	6	● 191692	● 191700	● 191708	● 191716



SCS certificate included.

nano

RN05-1 GO

RN15-1 GO

RN05-1 GO

RN15-1 GO

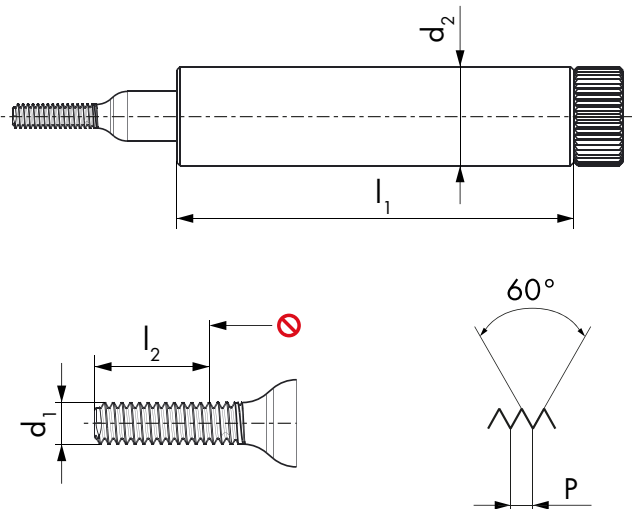

$\emptyset d_1$ S	P mm	l_1 mm	l_2 GO mm	d_2 mm	ID	ID	ID	ID
0.3	0.08	24	0.61	6	● 190961	● 190999	● 191037	● 191075
0.35	0.09	24	0.71	6	● 190962	● 191000	● 191038	● 191076
0.4	0.1	24	0.8	6	● 190963	● 191001	● 191039	● 191077
0.5	0.125	24	1	6	● 190964	● 191002	● 191040	● 191078
0.6	0.15	24	1.2	6	● 190965	● 191003	● 191041	● 191079
0.7	0.175	24	1.4	6	● 190966	● 191004	● 191042	● 191080
0.8	0.2	24	1.6	6	● 190967	● 191005	● 191043	● 191081
0.9	0.225	24	1.8	6	● 190968	● 191006	● 191044	● 191082
1	0.25	24	2	6	● 190969	● 191007	● 191045	● 191083
1.2	0.25	24	2.3	6	● 190970	● 191008	● 191046	● 191084
1.4	0.3	24	2.7	6	● 190971	● 191009	● 191047	● 191085



SCS certificate included.

nano

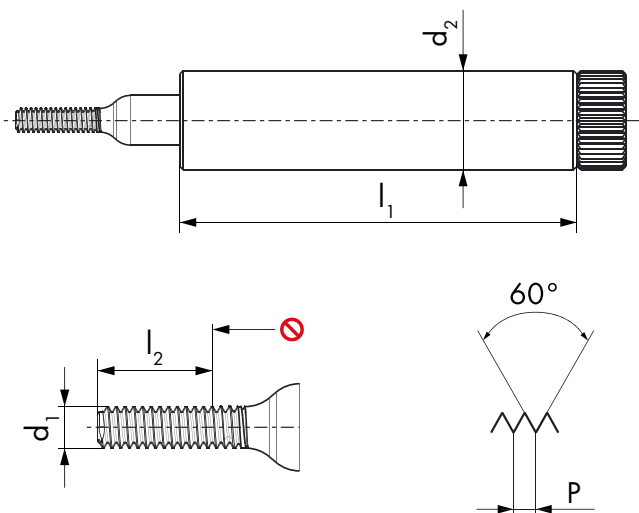

**RN05-2
NO-GO**

**RN15-2
NO-GO**

**RN05-2
NO-GO**

**RN15-2
NO-GO**



$\emptyset d_1$ S	P mm	l_1 mm	l_2 GO mm	d_2 mm	ID	ID	ID	ID
0.3	0.08	24	0.61	6	● 190980	● 191018	● 191056	● 191094
0.35	0.09	24	0.71	6	● 190981	● 191019	● 191057	● 191095
0.4	0.1	24	0.8	6	● 190982	● 191020	● 191058	● 191096
0.5	0.125	24	1	6	● 190983	● 191021	● 191059	● 191097
0.6	0.15	24	1.2	6	● 190984	● 191022	● 191060	● 191098
0.7	0.175	24	1.4	6	● 190985	● 191023	● 191061	● 191099
0.8	0.2	24	1.6	6	● 190986	● 191024	● 191062	● 191100
0.9	0.225	24	1.8	6	● 190987	● 191025	● 191063	● 191101
1	0.25	24	2	6	● 190988	● 191026	● 191064	● 191102
1.2	0.25	24	2.3	6	● 190989	● 191027	● 191065	● 191103
1.4	0.3	24	2.7	6	● 190990	● 191028	● 191066	● 191104



SCS certificate included.

nano

RN05-1 GO

RN15-1 GO

RN05-1 GO

RN15-1 GO

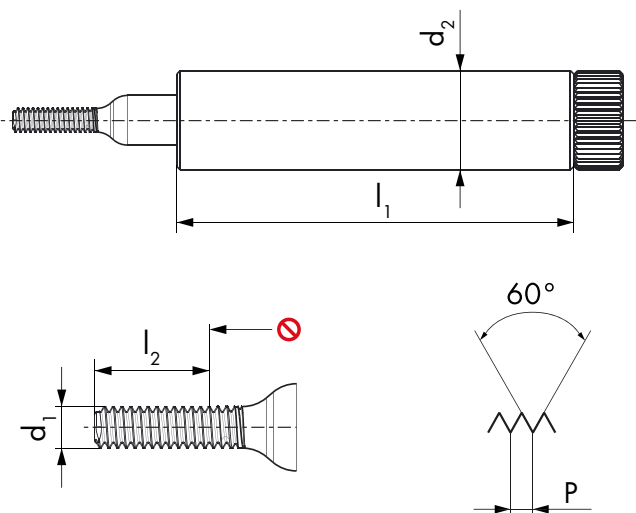

$\emptyset d_1$ SF	P mm	l_1 mm	l_2 GO mm	d_2 mm	ID	ID	ID	ID
1.4	0.2	24	2.5	6	● 190972	● 191010	● 191048	● 191086
1.6	0.2	24	2.2	6	● 190973	● 191011	● 191049	● 191087
1.8	0.2	24	2.2	6	● 190974	● 191012	● 191050	● 191088
2	0.2	24	2.2	6	● 190975	● 191013	● 191051	● 191089
2.2	0.2	24	2.2	6	● 190976	● 191014	● 191052	● 191090
2.2	0.25	24	2.75	6	● 190977	● 191015	● 191053	● 191091
2.5	0.2	24	2.2	6	● 190978	● 191016	● 191054	● 191092
2.5	0.25	24	2.75	6	● 190979	● 191017	● 191055	● 191093



SCS certificate included.

nano

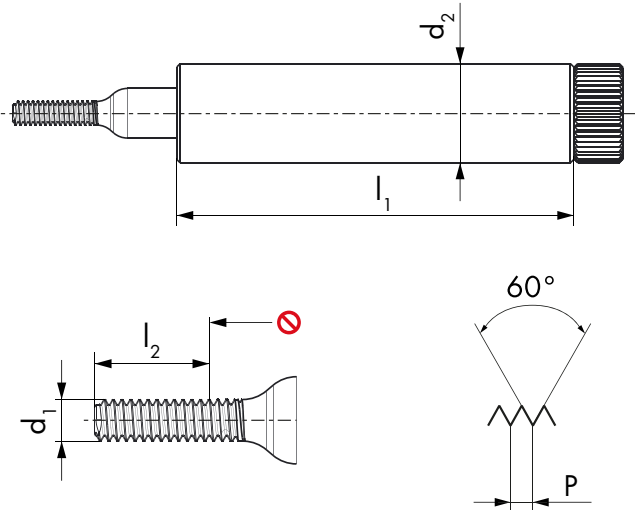

**RN05-2
NO-GO**

**RN15-2
NO-GO**

**RN05-2
NO-GO**

**RN15-2
NO-GO**



$\emptyset d_1$ SF	P mm	l_1 mm	l_2 GO mm	d_2 mm	ID	ID	ID	ID
1.4	0.2	24	2.5	6	● 190991	● 191029	● 191067	● 191105
1.6	0.2	24	1.6	6	● 190992	● 191030	● 191068	● 191106
1.8	0.2	24	1.6	6	● 190993	● 191031	● 191069	● 191107
2	0.2	24	1.6	6	● 190994	● 191032	● 191070	● 191108
2.2	0.2	24	1.6	6	● 190995	● 191033	● 191071	● 191109
2.2	0.25	24	2	6	● 190996	● 191034	● 191072	● 191110
2.5	0.2	24	1.6	6	● 190997	● 191035	● 191073	● 191111
2.5	0.25	24	2	6	● 190998	● 191036	● 191074	● 191112



SCS certificate included.

nano

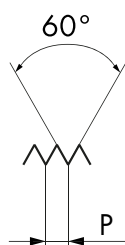
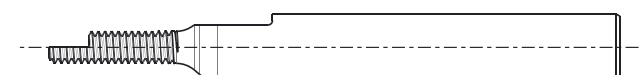
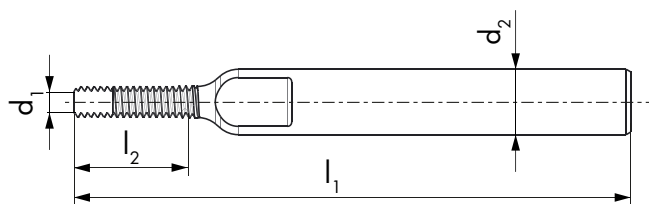

EN00



NIHS

$\varnothing d_1$ S	P mm	l_1 mm	l_2 GO mm	d_2 mm	ID
0.3	0.08	39	1.28	3	● 192747
0.35	0.09	39	1.44	3	● 192748
0.4	0.1	39	1.6	3	● 192749
0.5	0.125	39	2	3	● 192750
0.6	0.15	39	2.4	3	● 192751
0.7	0.175	39	2.8	3	● 192752
0.8	0.2	39	3.2	3	● 192753
0.9	0.225	39	3.6	3	● 192754
1	0.25	39	4	3	● 192755
1.2	0.25	39	4	3	● 192756
1.4	0.3	39	4.8	3	● 192757

La jauge étalon filettée de DC SWISS sert à calibrer les machines de mesure. Les étalons de notre catalogue, ou réalisés selon vos besoins spécifiques, sont livrés avec un certificat de mesure SCS confirmant que la production a suivi scrupuleusement le processus de contrôle au terme de la fabrication selon ISO 17025. Il atteste la qualité de l'équipement métrologique de DC NANO TOOLS SA (SCS 0143), centre de compétences et membre du Groupe DC SWISS.

Il campione filettato DC SWISS viene utilizzato per calibrare le macchine di misura. I campioni filettati del nostro catalogo o prodotti secondo le vostre specifiche esigenze, sono forniti con un certificato di misura SCS. Ciò conferma che il processo di controllo durante la produzione è stato scrupolosamente eseguito in conformità alla norma ISO 17025. Egli certifica la qualità delle apparecchiature metrologiche di DC NANO TOOLS SA (SCS 0143), centro di competenza e membro del Gruppo DC SWISS.



SCS certificate included.

La marque Micro-Safelock, inscrite et protégée par DC SWISS, identifie les outils bénéficiant du système Safelock garantissant l'assemblage autobloquant fileté, développé et breveté par DC SWISS.

Pour un diamètre inférieur à 1.50 mm, les exigences au niveau des champs de tolérance liés au filetage intérieur et extérieur sont telles que les moyens de production et de mesure conventionnels ne permettent pas une production industrielle des composants d'un assemblage fileté asymétrique autobloquant classique.

Ce micro-assemblage fileté asymétrique autobloquant normalisé, pour des diamètres allant de 0.30 à 1.40 mm, respectant les tolérances inhérentes aux micro-filetages, a été conçu et breveté sous le nom de Micro-Safelock. Il offre des performances exceptionnelles en termes de résistance aux chocs et aux vibrations, en s'inspirant de la technologie utilisée pour les assemblages de plus grandes dimensions et en intégrant pleinement la rampe à 30° au profil du filetage intérieur (écrou), afin de faciliter le montage de la vis.

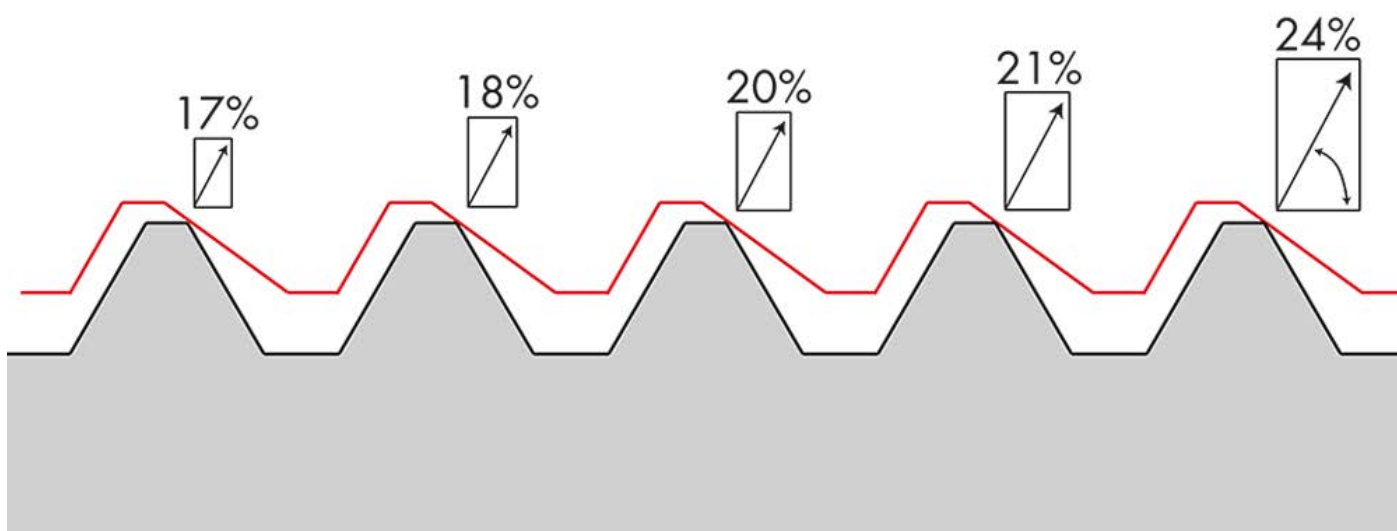

Lorsque le couple de serrage est appliqué, l'effort de traction exercé sur la vis provoque son auto-centrage et les pointes du profil de cette dernière sont mises en contact avec les flancs du profil asymétrique du filetage intérieur (rampe), engendrant ainsi un contact tangentiel et une répartition régulière de la charge sur tous les filets.

La réduction de la charge sur les premiers filets et l'orientation des contraintes vers une compression de la vis diminuent fortement la fatigue pesant sur l'assemblage vis/écrou, permettant ainsi de procéder à de nombreux cycles de montage/démontage, sans en altérer les caractéristiques.

Pour correspondre aux exigences dimensionnelles, l'âme de la vis a été amplement renforcée, par rapport à un filetage NIHS ou M à 60° de même dimension.

Par rapport à la norme NIHS, la longueur du pas a été réduite, afin d'augmenter la surface en contact entre les deux éléments de fixation, pour une même longueur utile. Il s'agit évidemment d'avantages considérables, particulièrement lors de l'emploi de matériaux tendres et de vis à petite tête avec une longueur de filetage réduite.

LES AVANTAGES DU PROFIL AUTOBLOQUANT

- Répartition de l'effort de traction sur toute la longueur du filetage
- Couple de blocage nominal jusqu'à 25% inférieur à celui d'un assemblage classique
- Intégralement mécanique sans adjuvants chimiques

LES AVANTAGES DE LA VIS

- Filetage avec tolérances adaptées aux exigences, permettant un contact ininterrompu entre vis et écrou
- Pas fin augmentant la surface en contact avec l'écrou pour une même longueur filetée
- Meilleure résistance à la traction grâce à un diamètre intérieur du profil accru de 19% (plus de 40% en coupe)
- Multiples assemblages et désassemblages sans altération des performances mécaniques

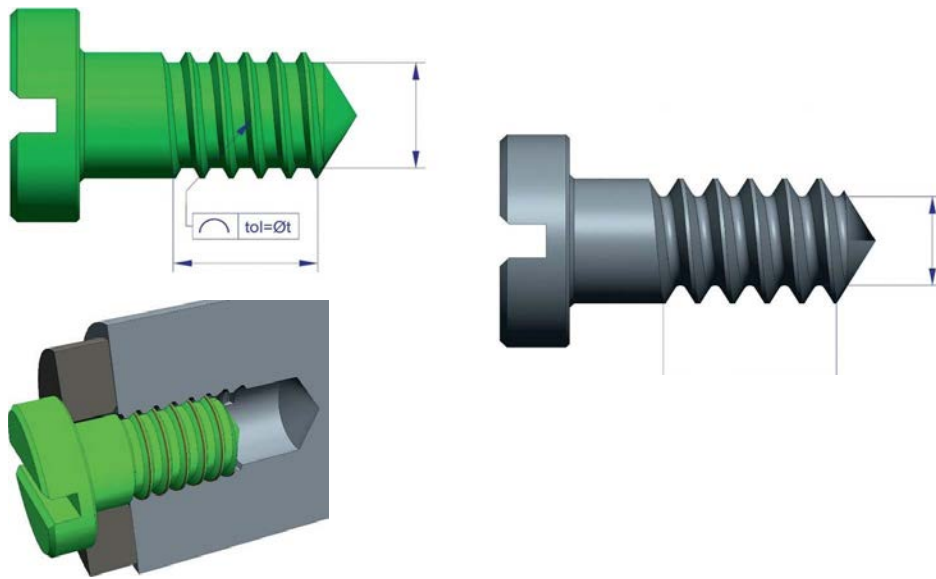

Les nombreux tests de résistance aux chocs effectués ont clairement démontrés que les assemblages filetés sont totalement fiables et qu'ils apportent aujourd'hui une réponse crédible aux problèmes influençant la tenue des vis.

Les couples de serrage qui ont été appliqués sur les vis des éprouvettes sont inférieurs de 25%, par rapport aux valeurs recommandées par les fabricants de revêtements "frein filet" chimiques.

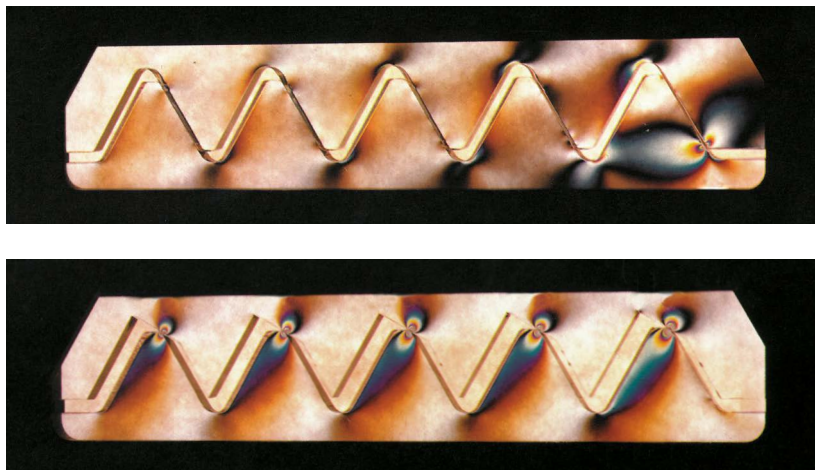

SAFELOCK DIMENSIONS ET NORMES

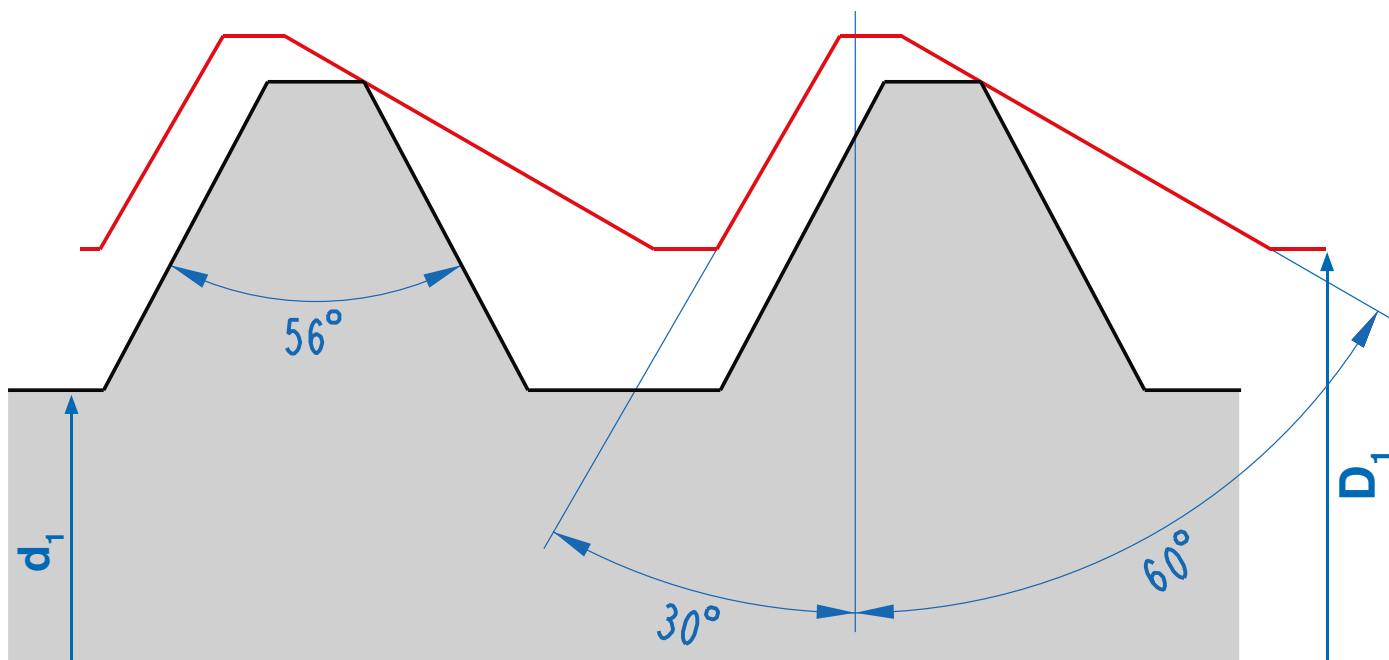

Dimension	Pas mm	d_1 mini mm	d_1 maxi mm	Angles flancs écrou	Angles flancs vis	d_1
SL 0.3	0.06	0.264	0.278	30°/60°	56°	0.247
SL 0.35	0.06	0.314	0.328	30°/60°	56°	0.297
SL 0.4	0.08	0.356	0.372	30°/60°	56°	0.331
SL 0.5	0.1	0.448	0.466	30°/60°	56°	0.416
SL 0.6	0.125	0.538	0.559	30°/60°	56°	0.496
SL 0.7	0.15	0.628	0.651	30°/60°	56°	0.576
SL 0.8	0.15	0.728	0.751	30°/60°	56°	0.676
SL 0.9	0.175	0.818	0.844	30°/60°	56°	0.756
SL 1.0	0.2	0.908	0.936	30°/60°	56°	0.836
SL 1.2	0.2	1.108	1.136	30°/60°	56°	1.036
SL 1.4	0.25	1.288	1.321	30°/60°	56°	1.197

Il marchio Micro-Safelock, registrato e protetto da DC SWISS, identifica gli utensili che beneficiano del sistema Safelock che garantisce l'assemblaggio autobloccante filettato, sviluppato e brevettato da DC SWISS.

Per diametri inferiori a 1.5 mm, i requisiti per la tolleranza di filettatura interna ed esterna sono tali che il metodo convenzionale per la produzione e la misurazione non consente la fabbricazione industriale di componenti per i tradizionali assemblaggi a vite autobloccanti asimmetrici.

Questo micro-assemblaggio standard autobloccante asimmetrico filettato per diametri che vanno da 0.30 a 1.40 mm, nel rispetto delle tolleranze inerenti alle filettature delle micro-vite, è stato progettato e brevettato con il nome di Micro-Safelock. Egli offre prestazioni eccezionali in termini di resistenza agli urti e alle vibrazioni, sulla base della tecnologia utilizzata per gli assemblaggi su larga scala e integrando completamente l'inclinazione di 30° nella filettatura interna (dado), rendendo più facile l'assemblaggio della vite.

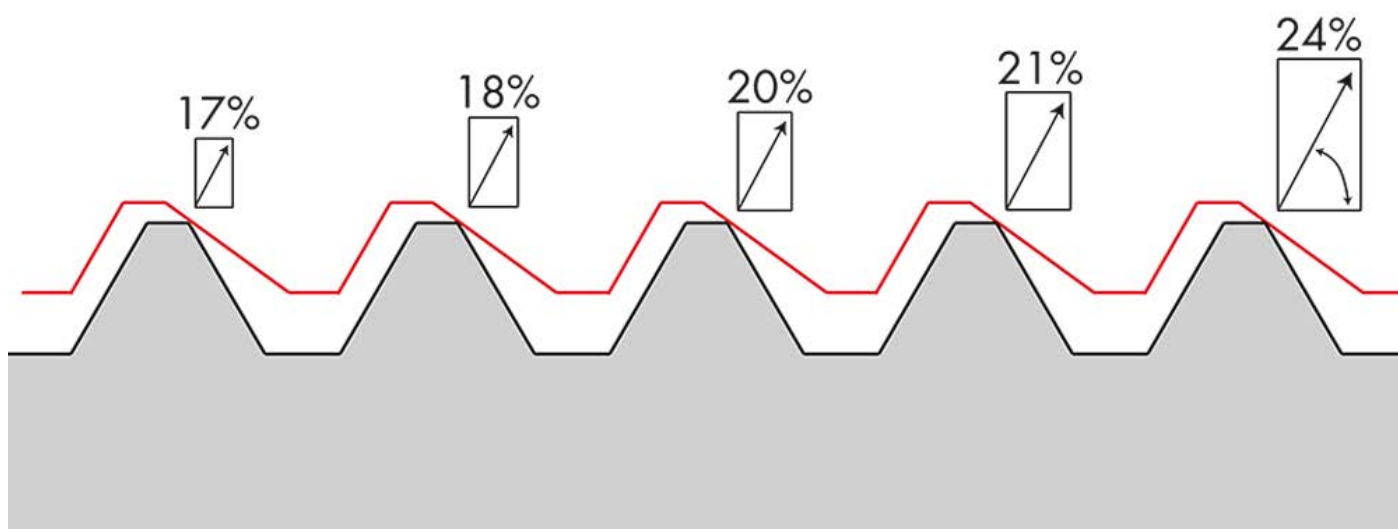

Quando si applica la coppia di serraggio, la forza di trazione esercitata sulla vite la costringe ad autocentrarsi, e i punti del profilo della vite entrano in contatto con i bordi del profilo asimmetrico della filettatura interna della vite (gradiente), portando così ad un contatto tangenziale e ad una regolare distribuzione del carico su tutti i giri della filettatura.

Riducendo il carico sui primi giri della filettatura e indirizzando la sollecitazione verso la compressione della vite si riduce notevolmente lo sforzo del gruppo vite / dado, rendendo così possibile il montaggio e lo smontaggio più volte senza modificarne le caratteristiche.

Per corrispondere alle esigenze dimensionali, il nucleo della vite è stato ampiamente rinforzato rispetto ad una filettatura di tipo NIHS o M a 60° della stessa dimensione.

La lunghezza del passo è stata ridotta rispetto allo standard NIHS per aumentare l'area di contatto tra i due elementi di fissaggio, a parità di lunghezza utile. Ciò offre ovviamente notevoli vantaggi, soprattutto quando si lavora con materiali morbidi e viti a testa piccola con una lunghezza di filettatura ridotta.

I VANTAGGI DELL'AUTOBLOCCAGGIO

- La forza di trazione è uniformemente distribuita su tutta la lunghezza della parte filettata della vite
- Coppia nominale di bloccaggio fino al 25 % in meno rispetto a quella di un assemblaggio convenzionale
- Completamente meccanico, senza additivi chimici

I VANTAGGI DELLA VITE

- Filettatura della vite con tolleranze adattate alle esigenze, consentendo un contatto ininterrotto tra vite e dado
- Passo fine, aumentando la superficie a contatto con il dado a parità di lunghezza della filettatura
- Migliore resistenza alla trazione grazie ad un diametro interno del profilo superiore del 19 % (oltre il 40 % in sezione)
- Montaggio/smontaggio multiplo senza modifiche delle proprietà meccaniche

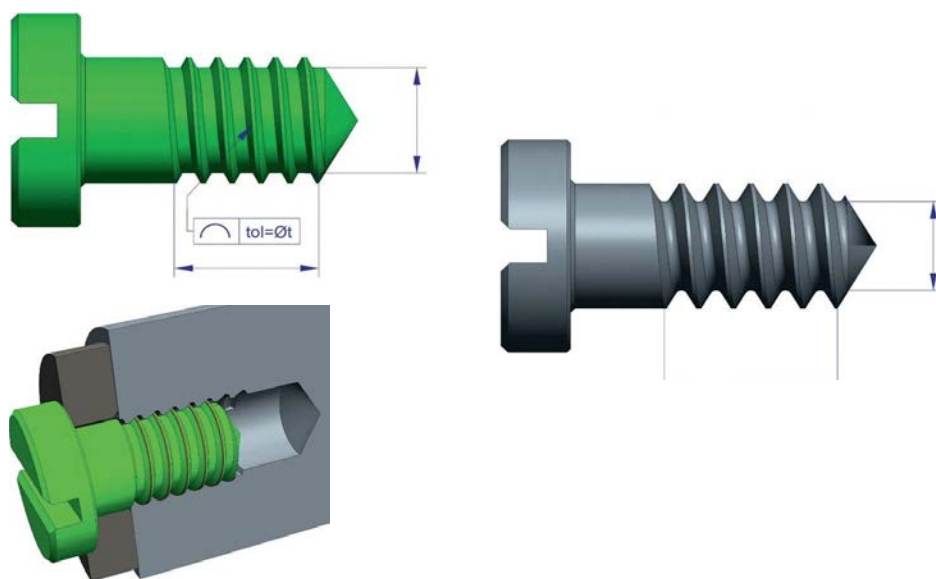

Le numerose prove di resistenza agli urti che sono state effettuate dimostrano chiaramente che i gruppi filettati sono totalmente affidabili e offrono ora una risposta credibile ai problemi di resistenza delle viti.

Le coppie di serraggio applicate alle viti campione sono inferiori del 25 % rispetto ai valori raccomandati dai produttori di rivestimenti chimici "frenafilletti".

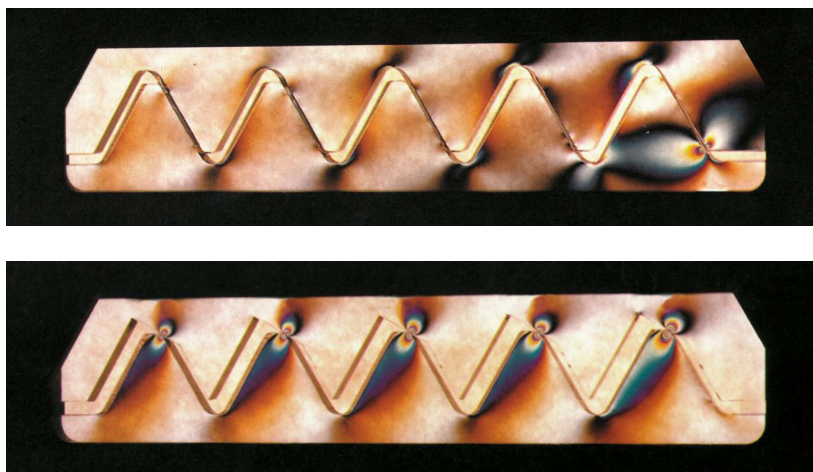

SAFELOCK DIMENSIONI E NORME

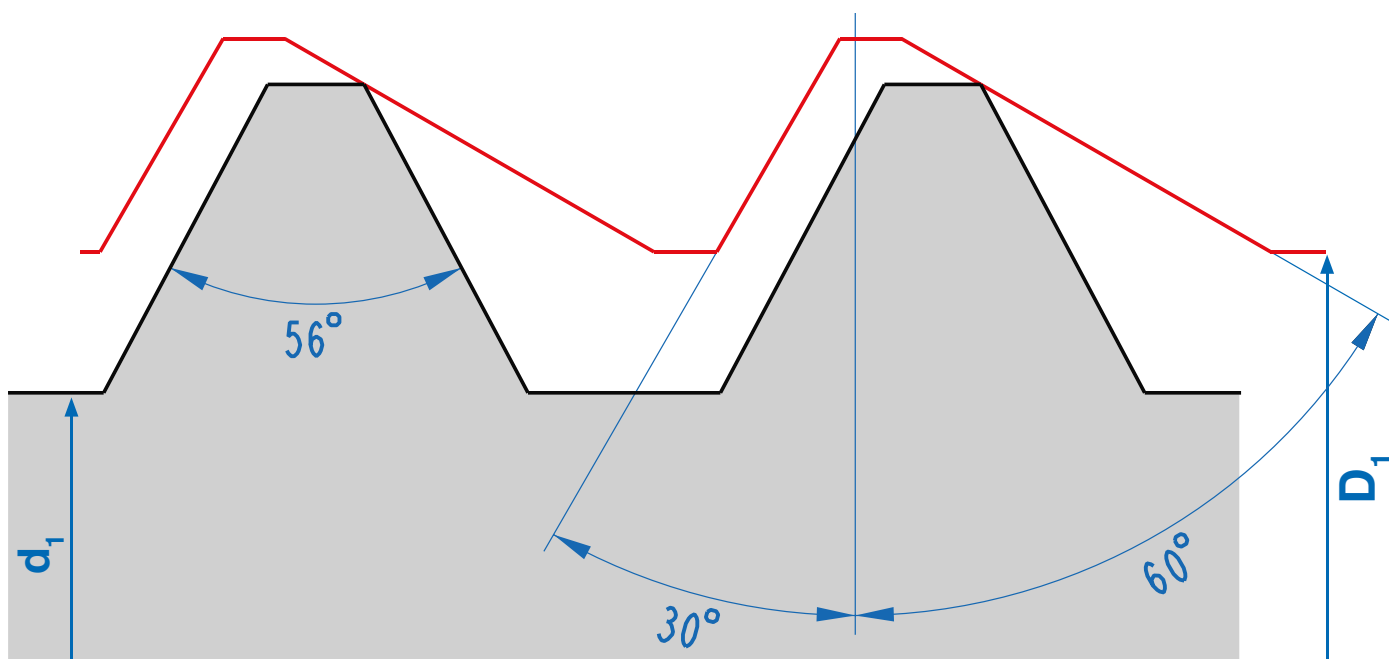

Dimensione	Passo mm	d_1 mini mm	d_1 maxi mm	Angoli dei fianchi del dado	Angoli dei fianchi della vite	d_1
SL 0.3	0.06	0.264	0.278	30°/60°	56°	0.247
SL 0.35	0.06	0.314	0.328	30°/60°	56°	0.297
SL 0.4	0.08	0.356	0.372	30°/60°	56°	0.331
SL 0.5	0.1	0.448	0.466	30°/60°	56°	0.416
SL 0.6	0.125	0.538	0.559	30°/60°	56°	0.496
SL 0.7	0.15	0.628	0.651	30°/60°	56°	0.576
SL 0.8	0.15	0.728	0.751	30°/60°	56°	0.676
SL 0.9	0.175	0.818	0.844	30°/60°	56°	0.756
SL 1.0	0.2	0.908	0.936	30°/60°	56°	0.836
SL 1.2	0.2	1.108	1.136	30°/60°	56°	1.036
SL 1.4	0.25	1.288	1.321	30°/60°	56°	1.197

TOLÉRANCES POUR FILETAGES M ET MF TOLLERANZE PER FILETTATURE M E MF

Filet d'écrou

Filettatura del dado

Tolérance 6H

- Numéro = degré de précision
- Lettre = position de la tolérance
- Lettre majuscule = filetage intérieur

Tolleranza 6H

- Numero = grado di precisione
- Lettera = posizione di tolleranza
- Lettera maiuscola = filettatura interna

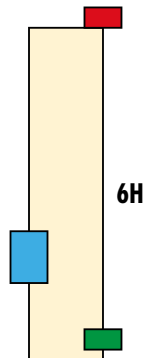
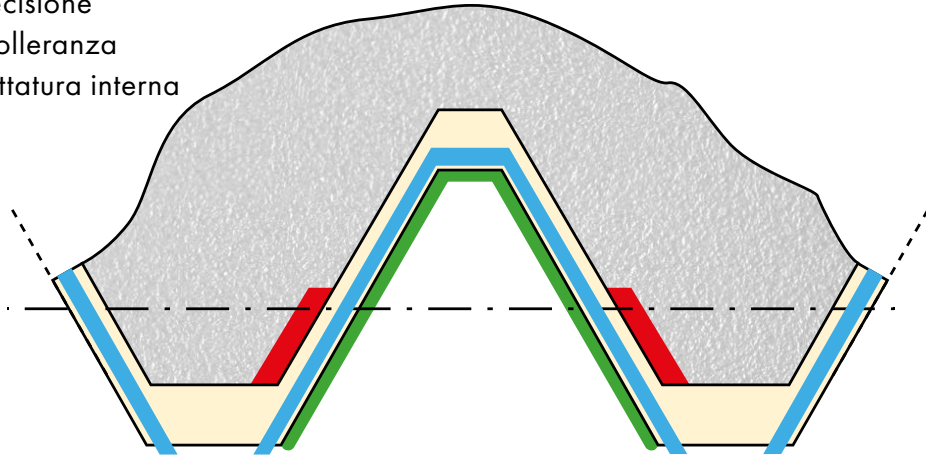

H/h=0

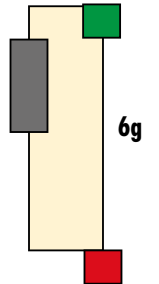
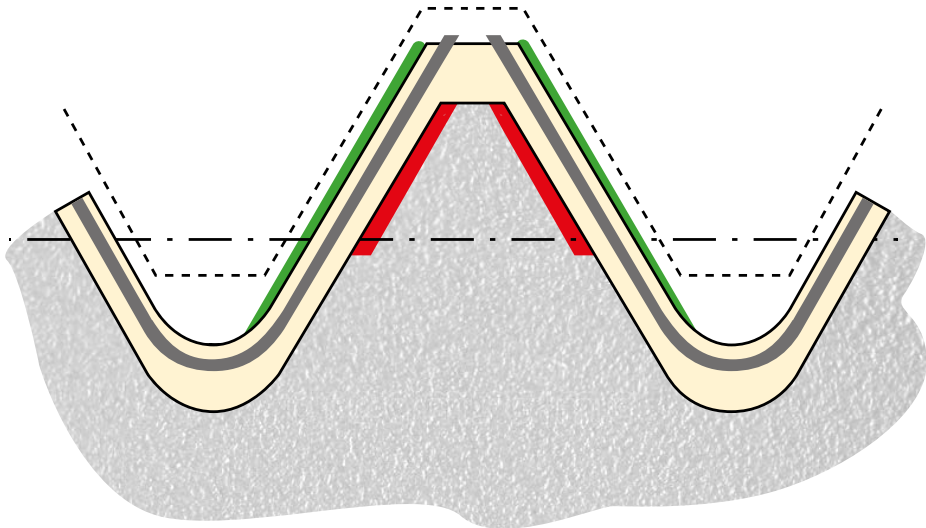

Filetage du boulon

Filettatura del bullone

Tolérance 6g

- Numéro = degré de précision
- Lettre minuscule = filetage extérieur

Tolleranza 6g

- Numero = grado di precisione
- Lettera minuscola = filettatura esterna

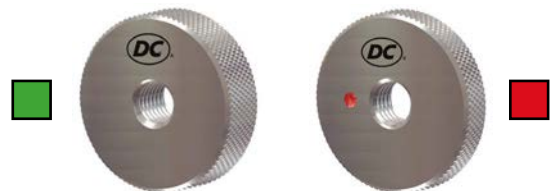

TOLÉRANCES POUR FILETAGES M ET MF TOLLERANZE PER FILETTATURE M E MF

G = surcote

G = maggiorazione

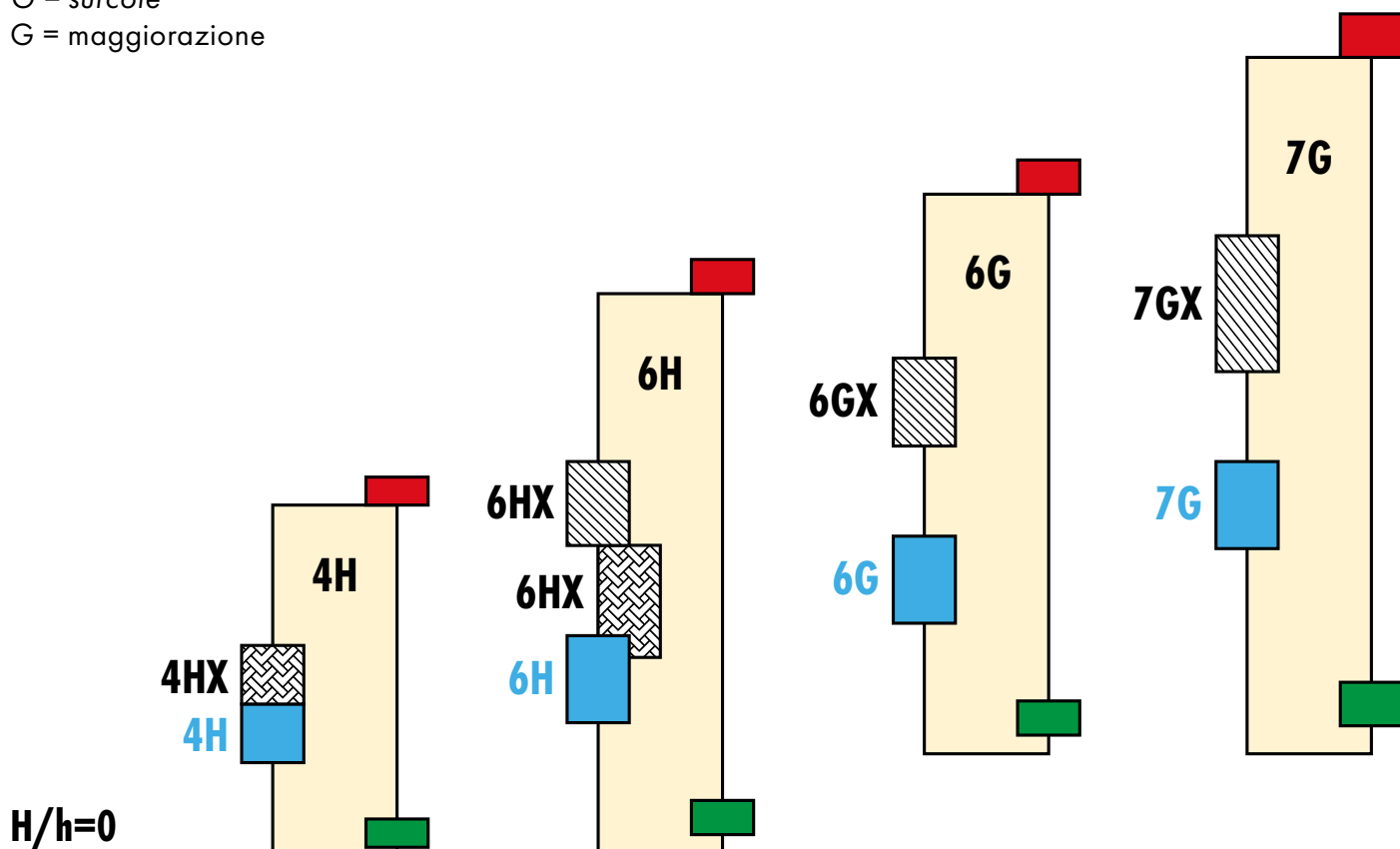

e = souscote

e = minorazione

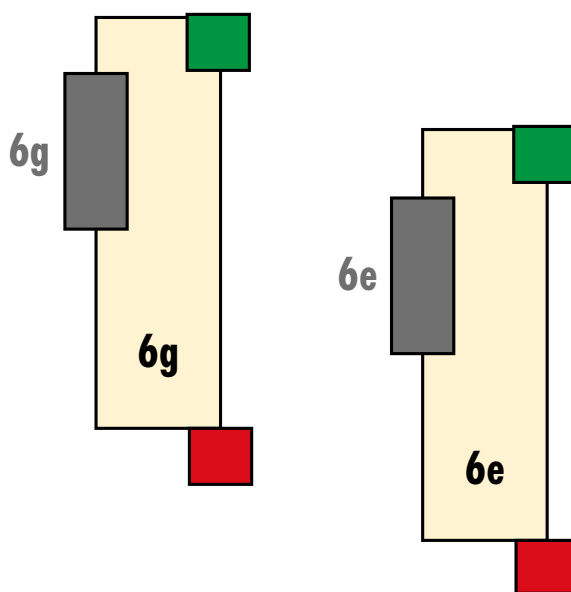

DÉSIGNATIONS DES TOLÉRANCES SELON NORME DIN EN 22857 POUR LES TARAUDS AVEC FILETAGES MÉTRIQUES ISO

La norme DIN 802, partie 1, a été remplacée par la norme DIN EN 22857, conforme au standard international.

Le tableau comparatif ci-après vous informe sur les relations entre les normes DIN EN 22857 et DIN 802, partie 1. Le changement le plus significatif se situe dans la zone de tolérance qui s'adapte aux nouvelles catégories d'utilisation.

Catégories d'utilisation des tarauds selon DIN EN 22857		Ancienne norme DIN 802, partie 1. Catégories de tolérances des tarauds	Zones de tolérances du taraudage sur la pièce				
Dénomination	Caractéristique						
Classe 1	ISO 1	4H	4H	5H	-	-	-
Classe 2	ISO 2	6H	4G	5G	6H	-	-
Classe 3	ISO 3	6G	-	-	6G	7H	8H
-	-	7G	-	-	-	7G	8G

Une période de transition doit être prévue avant l'introduction définitive de ces normes.

Les désignations de tolérances 7G / 8G et catégorie "X" ne figurent pas encore dans la nouvelle norme DIN EN 22857. Par conséquent, comme par le passé, il faut se conformer à l'ancienne norme DIN 802, partie 1.

DESIGNAZIONI DI TOLLERANZE SECONDO NORMA DIN EN 22857 PER MASCHI CON FILETTATURA METRICA ISO

La norma DIN 802, parte 1, è stata sostituita dalla nuova norma DIN EN 22857, conforme allo standard internazionale.

La tabella comparativa che segue, informa sulle relazioni tra le norme DIN EN 22857 e DIN 802, parte 1. Il cambiamento più significativo corrisponde alla zona di tolleranza che si adatta alle nuove categorie d'impiego.

Categoria d'utilizzo dei maschi secondo DIN EN 22857		Vecchia norma DIN 802, parte 1. Categorie di tolleranza dei maschi	Zona di tolleranza della maschiatura sul pezzo				
Denominazione	Caratteristica						
Classe 1	ISO 1	4H	4H	5H	-	-	-
Classe 2	ISO 2	6H	4G	5G	6H	-	-
Classe 3	ISO 3	6G	-	-	6G	7H	8H
-	-	7G	-	-	-	7G	8G

Deve essere previsto un periodo di transizione prima dell'introduzione definitiva di queste norme.

Le designazioni delle tolleranze 7G / 8G e categoria "X" non figurano ancora nella nuova norma DIN EN 22857. Pertanto, come in passato, fare riferimento alla vecchia norma DIN 802, parte 1.

FILETAGES MÉTRIQUES ISO DIN 13

Dimensions - Diamètres sur flancs

Dimensions nominales	Pas	Tolérance	Filetage de l'écrou diamètres sur flancs		Tolérance	Filetage de la vis diamètres sur flancs	
			min.	max.		max.	min.
M 1	(x0.25)	4H	0.838	0.883	6h	0.838	0.785
M 1.4	(x0.3)	4H	1.205	1.253	6h	1.205	1.149
M 1.6	(x0.35)	6H	1.373	1.458	6g	1.354	1.291
M 2	(x0.4)	6H	1.740	1.830	6g	1.721	1.654
M 2	x0.25	4H	1.838	1.886	6h	1.838	1.782
M 2.2	(x0.45)	6H	1.908	2.003	6g	1.888	1.817
M 2.5	(x0.45)	6H	2.208	2.303	6g	2.188	2.117
M 3	(x0.5)	6H	2.675	2.775	6g	2.655	2.580
M 3	x0.35	6H	2.773	2.863	6g	2.754	2.687
M 3.5	(x0.6)	6H	3.110	3.222	6g	3.089	3.004
M 4	(x0.7)	6H	3.545	3.663	6g	3.523	3.433
M 4	x0.5	6H	3.675	3.775	6g	3.655	3.580
M 4.5	(x0.75)	6H	4.013	4.131	6g	3.991	3.901
M 5	(x0.8)	6H	4.480	4.605	6g	4.456	4.361
M 6	(x1)	6H	5.350	5.500	6g	5.324	5.212
M 6	x0.75	6H	5.513	5.645	6g	5.491	5.391
M 6	x0.5	6H	5.675	5.787	6g	5.655	5.570
M 7	(x1)	6H	6.350	6.500	6g	6.324	6.212
M 8	(x1.25)	6H	7.188	7.348	6g	7.160	7.042
M 10	(x1.5)	6H	9.026	9.206	6g	8.994	8.862
M 12	(x1.75)	6H	10.863	11.063	6g	10.829	10.679
M 12	x1.5	6H	11.026	11.216	6g	10.994	10.854
M 12	x1.25	6H	11.188	11.368	6g	11.160	11.028
M 12	x1	6H	11.350	11.510	6g	11.324	11.206
M 12	x0.75	6H	11.513	11.653	6g	11.491	11.385
M 12	x0.5	6H	11.675	11.793	6g	11.655	11.565
M 14	(x2)	6H	12.701	12.913	6g	12.663	12.503
M 16	(x2)	6H	14.701	14.913	6g	14.663	14.503
M 18	(x2.5)	6H	16.376	16.600	6g	16.334	16.164
M 20	(x2.5)	6H	18.376	18.600	6g	18.334	18.164
M 22	(x2.5)	6H	20.376	20.600	6g	20.334	20.164
M 24	(x3)	6H	22.051	22.316	6g	22.003	21.803
M 24	x2	6H	22.701	22.925	6g	22.663	22.493
M 24	x1.5	6H	23.026	23.226	6g	22.994	22.844
M 24	x1	6H	23.350	23.520	6g	23.324	23.199
M 27	(x3)	6H	25.051	25.316	6g	25.003	24.803
M 30	(x3.5)	6H	27.727	28.007	6g	27.674	27.462
M 33	(x3.5)	6H	30.727	31.007	6g	30.674	30.462
M 36	(x4)	6H	33.402	33.702	6g	33.342	33.118
M 39	(x4)	6H	36.402	36.702	6g	36.342	36.118
M 42	(x4.5)	6H	39.077	39.392	6g	39.014	38.778
M 45	(x4.5)	6H	42.077	42.392	6g	42.014	41.778
M 48	(x5)	6H	44.752	45.087	6g	44.681	44.431
M 48	x4	6H	45.402	45.717	6g	45.342	45.106
M 48	x3	6H	46.051	46.331	6g	46.003	45.791
M 48	x2	6H	46.701	46.937	6g	46.663	46.483
M 48	1.5	6H	47.026	47.238	6g	46.994	46.834
M 48	x1	6H	47.350	47.530	6g	47.324	47.184
M 52	(x5)	6H	48.752	49.087	6g	48.681	48.431
M 56	(x5.5)	6H	52.428	52.783	6g	52.353	52.088
M 60	(x5.5)	6H	56.428	56.783	6g	56.353	56.088
M 64	(x6)	6H	60.103	60.478	6g	60.023	59.743
M 68	(x6)	6H	64.103	64.478	6g	64.023	63.743

Autres combinaisons diamètre-pas

En cas de besoin, des filetages avec des pas plus petits que ceux du tableau sont admis. Pour ces filetages, on calcule les dimensions nominales et limites par addition ou soustraction de la différence du diamètre nominal de ce filetage et de celui d'un filetage de pas désiré figurant au tableau. Par exemple, on calcule les dimensions nominales et les limites d'un filetage MF11 x 0.5 par addition de 5 mm à toutes les dimensions nominales et limites du filetage MF6 x 0.5 du tableau. Dans ce cas, les écarts et les tolérances restent inchangés. Bien entendu, pour le diamètre sur flancs, ces règles ne sont valables qu'à l'intérieur des limites d'une gamme de diamètres suivante :

de 0.99	à 1.4 mm	de 5.6	à 11.2 mm	de 45	à 90 mm
de 1.4	à 2.8 mm	de 11.2	à 22.4 mm	de 90	à 180 mm
de 2.8	à 5.6 mm	de 22.4	à 45.0 mm	de 180	à 355 mm

FILETTATURE METRICHE ISO DIN 13

Dimensioni nominali - diametri sui fianchi

Dimensioni nominali	Passo	Tolleranza	Filettatura dado		Tolleranza	Filettatura vite	
			Diametri sui fianchi			Diametri sui fianchi	
			mini	maxi		maxi	mini
M 1	(x0.25)	4H	0.838	0.883	6h	0.838	0.785
M 1.4	(x0.3)	4H	1.205	1.253	6h	1.205	1.149
M 1.6	(x0.35)	6H	1.373	1.458	6g	1.354	1.291
M 2	(x0.4)	6H	1.740	1.830	6g	1.721	1.654
M 2	x0.25	4H	1.838	1.886	6h	1.838	1.782
M 2.2	(x0.45)	6H	1.908	2.003	6g	1.888	1.817
M 2.5	(x0.45)	6H	2.208	2.303	6g	2.188	2.117
M 3	(x0.5)	6H	2.675	2.775	6g	2.655	2.580
M 3	x0.35	6H	2.773	2.863	6g	2.754	2.687
M 3.5	(x0.6)	6H	3.110	3.222	6g	3.089	3.004
M 4	(x0.7)	6H	3.545	3.663	6g	3.523	3.433
M 4	x0.5	6H	3.675	3.775	6g	3.655	3.580
M 4.5	(x0.75)	6H	4.013	4.131	6g	3.991	3.901
M 5	(x0.8)	6H	4.480	4.605	6g	4.456	4.361
M 6	(x1)	6H	5.350	5.500	6g	5.324	5.212
M 6	x0.75	6H	5.513	5.645	6g	5.491	5.391
M 6	x0.5	6H	5.675	5.787	6g	5.655	5.570
M 7	(x1)	6H	6.350	6.500	6g	6.324	6.212
M 8	(x1.25)	6H	7.188	7.348	6g	7.160	7.042
M 10	(x1.5)	6H	9.026	9.206	6g	8.994	8.862
M 12	(x1.75)	6H	10.863	11.063	6g	10.829	10.679
M 12	x1.5	6H	11.026	11.216	6g	10.994	10.854
M 12	x1.25	6H	11.188	11.368	6g	11.160	11.028
M 12	x1	6H	11.350	11.510	6g	11.324	11.206
M 12	x0.75	6H	11.513	11.653	6g	11.491	11.385
M 12	x0.5	6H	11.675	11.793	6g	11.655	11.565
M 14	(x2)	6H	12.701	12.913	6g	12.663	12.503
M 16	(x2)	6H	14.701	14.913	6g	14.663	14.503
M 18	(x2.5)	6H	16.376	16.600	6g	16.334	16.164
M 20	(x2.5)	6H	18.376	18.600	6g	18.334	18.164
M 22	(x2.5)	6H	20.376	20.600	6g	20.334	20.164
M 24	(x3)	6H	22.051	22.316	6g	22.003	21.803
M 24	x2	6H	22.701	22.925	6g	22.663	22.493
M 24	x1.5	6H	23.026	23.226	6g	22.994	22.844
M 24	x1	6H	23.350	23.520	6g	23.324	23.199
M 27	(x3)	6H	25.051	25.316	6g	25.003	24.803
M 30	(x3.5)	6H	27.727	28.007	6g	27.674	27.462
M 33	(x3.5)	6H	30.727	31.007	6g	30.674	30.462
M 36	(x4)	6H	33.402	33.702	6g	33.342	33.118
M 39	(x4)	6H	36.402	36.702	6g	36.342	36.118
M 42	(x4.5)	6H	39.077	39.392	6g	39.014	38.778
M 45	(x4.5)	6H	42.077	42.392	6g	42.014	41.778
M 48	(x5)	6H	44.752	45.087	6g	44.681	44.431
M 48	x4	6H	45.402	45.717	6g	45.342	45.106
M 48	x3	6H	46.051	46.331	6g	46.003	45.791
M 48	x2	6H	46.701	46.937	6g	46.663	46.483
M 48	1.5	6H	47.026	47.238	6g	46.994	46.834
M 48	x1	6H	47.350	47.530	6g	47.324	47.184
M 52	(x5)	6H	48.752	49.087	6g	48.681	48.431
M 56	(x5.5)	6H	52.428	52.783	6g	52.353	52.088
M 60	(x5.5)	6H	56.428	56.783	6g	56.353	56.088
M 64	(x6)	6H	60.103	60.478	6g	60.023	59.743
M 68	(x6)	6H	64.103	64.478	6g	64.023	63.743

Altre combinazioni diametro-passo

In caso di necessità, sono ammesse filettature con passi più piccoli di quelli indicati in tabella. Per queste filettature si calcolano le dimensioni nominali e i limiti mediante somma o sottrazione della differenza fra il diametro nominale di questa filettatura e quello della filettatura di passo desiderato, rappresentata in tabella. Ad esempio per calcolare le dimensioni nominali e i limiti di una filettatura MF11 x 0.5, si sommano 5 mm a tutte le dimensioni nominali e ai limiti della filettatura MF6 x 0.5 della tabella. In questo caso le differenze dimensionali e le tolleranze restano invariate. Resta inteso che, per il diametro sui fianchi, queste regole sono valide solo all'interno dei limiti dei seguenti diametri:

da 0.99	a 1.4 mm	da 5.6	a 11.2 mm	da 45	a 90 mm
da 1.4	a 2.8 mm	da 11.2	a 22.4 mm	da 90	a 180 mm
da 2.8	a 5.6 mm	da 22.4	a 45.0 mm	da 180	a 355 mm

FILETAGES MÉTRIQUES ISO

Tolérances sur flancs pour tarauds

Dimensions nominales Ø au-dessus		Pas	Classes de tolérances	Ecart inférieur	Ecart supérieur	Dimensions nominales Ø au-dessus		Pas	Classes de tolérances	Ecart inférieur	Ecart supérieur		
de	jusqu'à	P				de	jusqu'à	P					
0.99	1.4	0.2	ISO 1 / 4H	+ 5	+ 15	11.2	22.4	2.5	ISO 1 / 4H	+ 18	+ 54		
			ISO 1 / 4H	+ 6	+ 17				ISO 2 / 6H	+ 54	+ 90		
			ISO 1 / 4H	+ 6	+ 18				ISO 3 / 6G	+ 90	+ 126		
			ISO 2 / 6H	+ 18	+ 30				7G	+ 126	+ 162		
1.4	2.8	0.2	ISO 1 / 4H	+ 5	+ 15	22.4	45	1	ISO 1 / 4H	+ 13	+ 40		
			ISO 1 / 4H	+ 6	+ 18				ISO 2 / 6H	+ 40	+ 66		
			ISO 1 / 4H	+ 7	+ 20				ISO 3 / 6G	+ 66	+ 92		
			ISO 2 / 6H	+ 20	+ 34				7G	+ 92	+ 118		
			ISO 1 / 4H	+ 7	+ 21				1.5	ISO 1 / 4H	+ 16	+ 48	
			ISO 2 / 6H	+ 21	+ 36					ISO 2 / 6H	+ 48	+ 80	
ISO 1 / 4H	+ 8	+ 23	ISO 3 / 6G	+ 80	+ 112								
2.8	5.6	0.35	ISO 1 / 4H	+ 7	+ 21	7G	+ 112	+ 144	2	ISO 1 / 4H	+ 18	+ 54	
			ISO 2 / 6H	+ 21	+ 36		ISO 2 / 6H	+ 54		+ 90			
		0.5	ISO 1 / 4H	+ 8	+ 24	7G	+ 90	+ 126	3	ISO 1 / 4H	+ 21	+ 64	
			ISO 2 / 6H	+ 24	+ 40		ISO 2 / 6H	+ 64		+ 106			
			ISO 3 / 6G	+ 40	+ 55		ISO 3 / 6G	+ 106		+ 148			
		0.6	7G	+ 55	+ 70	7G	+ 148	+ 190	3.5	ISO 1 / 4H	+ 22	+ 67	
				ISO 1 / 4H	+ 9		+ 27	ISO 2 / 6H		+ 67	+ 112		
				ISO 2 / 6H	+ 27		+ 45	ISO 3 / 6G		+ 112	+ 157		
				ISO 3 / 6G	+ 45		+ 63	7G		+ 157	+ 202		
		0.7	7G	+ 63	+ 81	7G	+ 157	+ 202	4	ISO 1 / 4H	+ 24	+ 71	
				ISO 1 / 4H	+ 10		+ 29	ISO 2 / 6H		+ 71	+ 118		
		0.75	7G	+ 67	+ 86	7G	+ 165	+ 212	4.5	ISO 1 / 4H	+ 25	+ 75	
ISO 2 / 6H	+ 29			+ 48	ISO 2 / 6H		+ 75	+ 125					
ISO 3 / 6G	7G	+ 48	+ 67	7G	+ 175	+ 225	45	90	1.5	ISO 1 / 4H	+ 17	+ 51	
		ISO 3 / 6G	+ 48		+ 67	ISO 2 / 6H				+ 51	+ 85		
		7G	+ 67		+ 86	ISO 3 / 6G				+ 85	+ 119		
		7G	+ 86		+ 113	7G				+ 119	+ 153		
5.6	11.2	1	ISO 1 / 4H	+ 12	+ 35	2	ISO 1 / 4H	+ 19	+ 57	3	ISO 1 / 4H	+ 22	+ 67
			ISO 2 / 6H	+ 35	+ 59			ISO 2 / 6H	+ 57		+ 95		
			ISO 3 / 6G	+ 59	+ 83			ISO 3 / 6G	+ 95		+ 133		
			7G	+ 83	+ 107			7G	+ 133		+ 171		
		1.25	7G	+ 88	+ 113	7G	+ 133	+ 171	4	ISO 1 / 4H	+ 25	+ 75	
				ISO 1 / 4H	+ 13		+ 38	ISO 2 / 6H		+ 75	+ 125		
				ISO 2 / 6H	+ 38		+ 63	ISO 3 / 6G		+ 125	+ 175		
				ISO 3 / 6G	+ 63		+ 88	7G		+ 175	+ 225		
		1.5	7G	+ 88	+ 113	7G	+ 175	+ 225	5	ISO 1 / 4H	+ 27	+ 80	
				ISO 1 / 4H	+ 14		+ 42	ISO 2 / 6H		+ 80	+ 133		
				ISO 2 / 6H	+ 42		+ 70	ISO 3 / 6G		+ 133	+ 186		
				ISO 3 / 6G	+ 70		+ 98	7G		+ 186	+ 239		
11.2	22.4	1	ISO 1 / 4H	+ 13	+ 38	5.5	ISO 1 / 4H	+ 28	+ 84	6	ISO 1 / 4H	+ 30	+ 90
			ISO 2 / 6H	+ 38	+ 63			ISO 2 / 6H	+ 84		+ 140		
			ISO 3 / 6G	+ 63	+ 88			ISO 3 / 6G	+ 140		+ 196		
			7G	+ 88	+ 113			7G	+ 196		+ 252		
		1.25	7G	+ 98	+ 126	7G	+ 196	+ 252	6	ISO 2 / 6H	+ 90	+ 150	
				ISO 1 / 4H	+ 14		+ 42	ISO 3 / 6G		+ 150	+ 210		
				ISO 2 / 6H	+ 42		+ 70	7G		+ 210	+ 270		
				ISO 3 / 6G	+ 70		+ 98						
		1.5	7G	+ 105	+ 135	7G	+ 210	+ 270					
				ISO 1 / 4H	+ 15		+ 45						
				ISO 2 / 6H	+ 45		+ 75						
				ISO 3 / 6G	+ 75		+ 105						
1.75	7G	+ 105	+ 135	7G	+ 210	+ 270							
		ISO 1 / 4H	+ 16		+ 48								
		ISO 2 / 6H	+ 48		+ 80								
		ISO 3 / 6G	+ 80		+ 112								
2	7G	+ 112	+ 144	7G	+ 210	+ 270							
		ISO 1 / 4H	+ 17		+ 51								
		ISO 2 / 6H	+ 51		+ 85								
		ISO 3 / 6G	+ 85		+ 119								
7G	7G	+ 119	+ 153	7G	+ 210	+ 270							

FILETTATURA METRICA ISO

Tolleranza dei diametri sui fianchi

Filettatura nominale Ø		Passo	Classe di tolleranza	Limite inferiore	Limite superiore	Filettatura nominale Ø		Passo	Classe di tolleranza	Limite inferiore	Limite superiore		
da	sino a	P				da	sino a	P					
0.99	1.4	0.2	ISO 1 / 4H	+ 5	+ 15	11.2	22.4	2.5	ISO 1 / 4H	+ 18	+ 54		
		0.25	ISO 1 / 4H	+ 6	+ 17				ISO 2 / 6H	+ 54	+ 90		
		0.3	ISO 1 / 4H	+ 6	+ 18				ISO 3 / 6G	+ 90	+ 126		
			ISO 2 / 6H	+ 18	+ 30				7G	+ 126	+ 162		
1.4	2.8	0.2	ISO 1 / 4H	+ 5	+ 15			22.4	45	1	ISO 1 / 4H	+ 13	+ 40
		0.25	ISO 1 / 4H	+ 6	+ 18						ISO 2 / 6H	+ 40	+ 66
		0.35	ISO 1 / 4H	+ 7	+ 20						ISO 3 / 6G	+ 66	+ 92
			ISO 2 / 6H	+ 20	+ 34					7G	+ 92	+ 118	
		0.4	ISO 1 / 4H	+ 7	+ 21					1.5	ISO 1 / 4H	+ 16	+ 48
				ISO 2 / 6H	+ 21						+ 36	ISO 2 / 6H	+ 48
0.45	ISO 1 / 4H			+ 8	+ 23			ISO 3 / 6G	+ 80		+ 112		
	ISO 2 / 6H	+ 23	+ 38	7G	+ 112			+ 144					
2.8	5.6	0.35	ISO 1 / 4H	+ 7	+ 21	2	ISO 1 / 4H	+ 18	+ 54				
			ISO 2 / 6H	+ 21	+ 36			ISO 2 / 6H	+ 54	+ 90			
		0.5	ISO 1 / 4H	+ 8	+ 24			ISO 3 / 6G	+ 90	+ 126			
			ISO 2 / 6H	+ 24	+ 40			7G	+ 126	+ 162			
			ISO 3 / 6G	+ 40	+ 55			3	ISO 1 / 4H	+ 21	+ 64		
		7G		+ 55	+ 70				ISO 2 / 6H	+ 64	+ 106		
		0.6	ISO 1 / 4H	+ 9	+ 27				ISO 3 / 6G	+ 106	+ 148		
			ISO 2 / 6H	+ 27	+ 45				7G	+ 148	+ 190		
		ISO 3 / 6G	+ 45	+ 63	3.5				ISO 1 / 4H	+ 22	+ 67		
			7G	+ 63					+ 81	ISO 2 / 6H	+ 67	+ 112	
		0.7	ISO 1 / 4H	+ 10	+ 29				ISO 3 / 6G	+ 112	+ 157		
			ISO 2 / 6H	+ 29	+ 48				7G	+ 157	+ 202		
		0.75	ISO 2 / 6H	+ 29	+ 48				4	ISO 1 / 4H	+ 24	+ 71	
				ISO 3 / 6G	+ 48					+ 67	ISO 2 / 6H	+ 71	+ 118
0.8	ISO 3 / 6G	+ 48	+ 67	ISO 3 / 6G	+ 118	+ 165							
		7G	+ 67	+ 86	7G	+ 165	+ 212						
		0.8	ISO 1 / 4H	+ 10	+ 30	4.5	ISO 1 / 4H		+ 25	+ 75			
			ISO 2 / 6H	+ 30	+ 50		ISO 2 / 6H		+ 75	+ 125			
ISO 3 / 6G	+ 50	+ 70	ISO 3 / 6G	+ 125	+ 175								
	7G	+ 70	+ 90	7G	+ 175		+ 225						
5.6	11.2	1	ISO 1 / 4H	+ 12	+ 35		45	90	1.5	ISO 1 / 4H	+ 17	+ 51	
			ISO 2 / 6H	+ 35	+ 59					ISO 2 / 6H	+ 51	+ 85	
			ISO 3 / 6G	+ 59	+ 83					ISO 3 / 6G	+ 85	+ 119	
			7G	+ 83	+ 107				7G	+ 119	+ 153		
		1.25	ISO 1 / 4H	+ 13	+ 38				2	ISO 1 / 4H	+ 19	+ 57	
			ISO 2 / 6H	+ 38	+ 63					ISO 2 / 6H	+ 57	+ 95	
			ISO 3 / 6G	+ 63	+ 88					ISO 3 / 6G	+ 95	+ 133	
		7G		+ 88	+ 113					7G	+ 133	+ 171	
		1.5	ISO 1 / 4H	+ 14	+ 42					3	ISO 1 / 4H	+ 22	+ 67
				ISO 2 / 6H	+ 42						+ 70	ISO 2 / 6H	+ 67
ISO 3 / 6G	+ 70			+ 98	ISO 3 / 6G	+ 112	+ 157						
7G	+ 98			+ 126	7G	+ 157	+ 202						
11.2	22.4	1	ISO 1 / 4H	+ 13	+ 38	4	ISO 1 / 4H	+ 25			+ 75		
			ISO 2 / 6H	+ 38	+ 63			ISO 2 / 6H			+ 75	+ 125	
			ISO 3 / 6G	+ 63	+ 88			ISO 3 / 6G	+ 125		+ 175		
			7G	+ 88	+ 113			7G	+ 175		+ 225		
		1.25	ISO 1 / 4H	+ 14	+ 42			5	ISO 1 / 4H		+ 27	+ 80	
			ISO 2 / 6H	+ 42	+ 70				ISO 2 / 6H		+ 80	+ 133	
			ISO 3 / 6G	+ 70	+ 98				ISO 3 / 6G	+ 133	+ 186		
		7G		+ 98	+ 126				7G	+ 186	+ 239		
		1.5	ISO 1 / 4H	+ 15	+ 45				5.5	ISO 1 / 4H	+ 28	+ 84	
				ISO 2 / 6H	+ 45					+ 75	ISO 2 / 6H	+ 84	+ 140
				ISO 3 / 6G	+ 75					+ 105	ISO 3 / 6G	+ 140	+ 196
				7G	+ 105					+ 135	7G	+ 196	+ 252
1.75	ISO 1 / 4H	+ 16	+ 48	6	ISO 1 / 4H	+ 30	+ 90						
		ISO 2 / 6H	+ 48		+ 80	ISO 2 / 6H	+ 90			+ 150			
		ISO 3 / 6G	+ 80		+ 112	ISO 3 / 6G	+ 150			+ 210			
		7G	+ 112		+ 144	7G	+ 210			+ 270			
2	ISO 1 / 4H	+ 17	+ 51		6	ISO 1 / 4H	+ 30	+ 90					
		ISO 2 / 6H	+ 51			+ 85	ISO 2 / 6H	+ 90		+ 150			
		ISO 3 / 6G	+ 85			+ 119	ISO 3 / 6G	+ 150		+ 210			
		7G	+ 119			+ 153	7G	+ 210		+ 270			

REMARQUES INTÉRESSANTES POUR LE TARAUDAGE

Des conditions optimales d'utilisation permettent de réduire les temps d'usinage effectifs de fabrication, donc optimiser le rendement et le temps de vie de l'outil.

Choix efficace du taraud

Le choix d'un taraud ou d'un refouleur est dépendant de la matière et de ses caractéristiques.

Il est admis que des matériaux avec un allongement à la rupture de minimum 10% peuvent être déformés à froid.

Pour le choix optimal d'un taraud, voir nos tabelles d'utilisation.

Perçage

- Les trous de perçage doivent être propres et sans copeaux.
- Les diamètres de perçages sont à choisir selon la norme, extrait dans la partie technique de ce catalogue, et suivant les problèmes de taraudage, à tenir dans le champ supérieur de la tolérance.

Lubrification - Centre d'usinage

Le lubrifiant utilisé sur un centre d'usinage est souvent de concentration trop faible pour le taraudage. S'il n'est pas possible d'ajouter du concentré, on peut résoudre le problème par d'autres procédés, comme par exemple :

Lubrifier seulement avec l'additif de l'émulsion

- A. Un appareil de lubrification, commandé par la machine, projette l'additif dans l'avant-trou ou sur le taraud.
- B. Une pompe commandée par la machine apporte l'additif depuis un bac séparé dans l'avant-trou.

Taraudage en reprise

Cette solution permet l'utilisation d'un lubrifiant idéal.

Vitesse de coupe pour tarauds

La vitesse de coupe a une grande influence sur l'évacuation des copeaux et sur la longévité du taraud. Il est donc rentable de déterminer la vitesse de coupe idéale par des essais. Valeurs indicatives : voir tabelles d'utilisation DC.

La vitesse de coupe doit être adaptée aux caractéristiques et à l'équipement de la machine.

Conséquences d'une vitesse de coupe inadaptée :

- soudures froides
- rupture de l'entrée provoquée par la surcharge des dents
- filetages arrachés
- durée de vie de l'outil insuffisante
- filetages hors tolérances

REMARQUES INTÉRESSANTES POUR LE TARAUDAGE

Soudures froides

Quelles sont les raisons qui provoquent les soudures froides?

- Vitesse de coupe trop haute ou trop basse
- Mauvais choix du taraud
- Taraud avec géométrie de coupe inadaptée
- Lubrifiant non approprié à la matière
- Lubrifiant en quantité insuffisante
- Pression ou traction sur le taraud
- Avant-trou trop petit
- Parois de l'avant-trou rugueuse
- copeaux de perçage dans l'avant-trou
- Erreur de centrage
- Mal-rond

Conséquences des soudures froides :

- filetage arraché
- durée de vie de l'outil insuffisante
- taraudage rebuté
- casse du taraud
- pièces rebutées

Montage du taraud

- La fixation du taraud doit être dans le même axe que celui du trou à tarauder.
- Si la machine n'est pas parfaitement synchronisée (interpolation avance/rotation), nous recommandons l'utilisation d'une broche de taraudage qui permet de compenser la différence entre l'avance et le pas du taraud.

Mandrins pour le taraudage

Si la broche de la machine n'est pas parfaitement synchronisée (avance/rotation), l'avance à programmer doit être de 5 à 10% inférieure au pas. Dans ce cas, il faut utiliser un mandrin qui permet de compenser la différence entre l'avance et le pas du taraud.

Il est important que le ressort d'extension soit réglé de sorte à ne pas exercer une forte traction sur le taraud.

Le ressort de compression est à régler de sorte que le taraud amorce en comprimant le ressort au maximum jusqu'à $0.5 \times P$.

Notes importantes :

Une bonne stabilité de la machine et du porte-outils est un facteur important pour obtenir un rendement optimal.

Assurez-vous que la bonne vitesse de coupe est sélectionnée.

Veillez à utiliser suffisamment de lubrifiant lors du taraudage.

OSSERVAZIONI INTERESSANTI PER LA MASCHIATURA

Condizioni ottimali di utilizzo permettono di ridurre i tempi di lavoro quindi migliorare il rendimento e la vita dell'utensile.

Scelta appropriata del maschio

La scelta di un maschio ad asportazione o di uno a rullare dipende dal materiale e dalle sue caratteristiche.

In linea di massima i materiali con un allungamento di almeno il 10 % possono essere deformati a freddo.

Per la scelta ottimale di un maschio, fare riferimento alle nostre tabelle d'impiego.

Foratura

— I fori devono essere puliti e privi di trucioli.

— I diametri di preforatura devono essere scelti secondo le norme (estratto in questo catalogo nella parte tecnica) ed in funzione dei problemi di maschiatura, tenendoli al massimo della tolleranza.

Lubrificazione - Centri di lavoro

Il lubrificante utilizzato in un centro di lavoro ha spesso una percentuale troppo bassa per la maschiatura. Se non è fattibile aumentare la percentuale di lubrificante è possibile risolvere il problema con altre soluzioni, per esempio:

Lubrificare solamente con emulsione concentrata

- A. Un apparecchio di lubrificazione, comandato dalla macchina utensile, spruzza l'additivo indirizzandolo nel preforo o sul maschio.
- B. Una pompa comandata dalla macchina, apporta l'additivo da un serbatoio separato, nel preforo.

Maschiatura fuori macchina

Questa soluzione permette l'utilizzazione di un lubrificante ideale.

Velocità di taglio per maschi

La velocità di taglio ha un'enorme influenza sull'evacuazione del truciolo e sulla durata del maschio. È importante determinare la velocità di taglio ideale attraverso delle prove.

La velocità di taglio deve essere adattata in funzione dei materiali, della macchina e dell'attrezzaggio.

Conseguenze di una errata velocità di taglio

- saldature fredde
- rottura dell'imbocco provocata dal sovraccarico dei denti
- filetti strappati
- insufficiente durata dell'utensile
- filettature fuori tolleranza

OSSERVAZIONI INTERESSANTI PER LA MASCHIATURA

Saldature fredde

Quali sono le ragioni che provocano le saldature fredde?

- Velocità di taglio troppo elevata o troppo bassa
- Errata scelta del maschio
- Maschio con geometria di taglio inadatta
- Lubrificante non appropriato al tipo di materiale
- Insufficiente quantità di lubrificante
- Pressione o trazione assiale sul maschio
- Preforo troppo piccolo
- Pareti del preforo rovinate
- Trucioli di foratura nel preforo
- Errore di centratura
- Errore di concentricità

Conseguenze delle saldature fredde:

- filettatura strappata
- breve durata dell'utensile
- filettature fuori tolleranza
- rottura del maschio
- pezzi di scarto

Serraggio del maschio

- Il maschio deve essere montato in macchina sullo stesso asse del foro da maschiare.
- Se la macchina non è perfettamente sincronizzata, (avanzamento/rotazione), raccomandiamo l'impiego di un mandrino per maschiatura che permetta di compensare la differenza tra l'avanzamento e il passo del maschio.

Mandrini per la maschiatura

Se il mandrino della macchina non è perfettamente sincronizzato (avanzamento/rotazione) l'avanzamento da programmare deve essere dal 5 al 10 % inferiore al passo. In questo caso, si deve impiegare un mandrino che permetta di compensare la differenza fra l'avanzamento e il passo del maschio.

È importante che la molla di estensione sia regolata in modo da esercitare una forte trazione sul maschio.

La molla di compressione è regolata in modo che il maschio inizi il lavoro comprimendo la molla al massimo sino a $0.5 \times P$.

Note importanti:

Una buona rigidità e stabilità sia del porta utensile che della macchina sono una condizione necessaria per ottenere un rendimento ottimale.

Assicurarsi che sia selezionata la corretta velocità di taglio.

Accertarsi che durante la maschiatura venga utilizzato abbondante lubrificante.

OPTIMALISATION DU RENDEMENT DES TARAUDS

Problème	Causes	Solutions
Écaillage des dents du taraud	Copeaux bloqués	Vérifier la vitesse de coupe. Revoir le choix du taraud (K / N.62.-3 / Z.70VS).
	Taraud venant buter au fond du trou	Contrôler la profondeur de perçage et de taraudage. Percer le trou plus profond.
	Irrégularité des structures des matières	Adapter la vitesse de coupe. Améliorer la qualité du lubrifiant. Utilisez un taraud avec une autre géométrie de coupe / un autre revêtement.
	Affûtage incorrect	Lors du réaffûtage d'un taraud, reproduire les valeurs d'affûtage effectuées à l'origine par le fabricant.

Problème	Causes	Solutions
Usure excessive	Vitesse de coupe mal adaptée	Choisir la vitesse correcte compte tenu de la matière à usiner. Choix d'un revêtement.
	Manque de lubrifiant ou mauvais choix	Revoir le choix du lubrifiant. S'assurer que les arêtes de coupe soient bien lubrifiées.
	La surface intérieure du trou est écrouie	Conduire l'opération de perçage préalable de telle sorte que la matière s'écrouisse le moins possible. Revoir les conditions de perçage et l'état de l'arête de coupe du foret.
	Synchronisation	Vérifier l'état du synchronisme. Éviter le taraudage rigide dans les matières à caractéristiques mécaniques élevées.

Problème	Causes	Solutions
Casse du taraud	Mauvais choix du type de taraud selon la matière à usiner	Revoir le choix approprié par rapport au travail à effectuer.
	Copeaux	Adapter la géométrie à la profondeur à tarauder. Adapter la longueur de goujures si nécessaire.
	Mauvais alignement	S'assurer de l'alignement correct du taraud avec le trou percé.
	Taraud émoussé	Utiliser toujours des tarauds bien affûtés. Bien protéger les tarauds lors du stockage.
	Taraud venant buter au fond du trou	Utiliser une broche de taraudage avec embrayage (non recommandé pour machine CNC) et compensation axiale.
	Diamètre de perçage trop petit	Choisir diamètre de perçage selon table, voir partie technique de ce catalogue.

OPTIMALISATION DU RENDEMENT DES TARAUDS

Problème	Causes	Solutions
Taraudage trop grand	Mauvais choix du taraud (géométrie de coupe pas adaptée à la matière)	Vérifier le choix du type de taraud par rapport à la matière utilisée.
	Mauvais alignement	S'assurer que le taraud et le trou sont correctement alignés sur le même axe.
	Soudures froides	Revoir le choix du lubrifiant et s'assurer que les arêtes de coupe soient bien lubrifiées. Adapter la vitesse de coupe. Analyser le besoin de traitement ou revêtement.
	Taraud réaffûté (l'entrée conique n'est pas concentrique)	Réaffûter les entrées des tarauds sur une machine à rectifier en parfait état.

Problème	Causes	Solutions
Erreur de pas	Mauvais choix du taraud (géométrie de coupe pas adaptée à la matière)	Vérifier le choix du type de taraud par rapport à la matière utilisée.
	Avance de la broche et vitesse de rotation mal synchronisées	Contrôler la programmation ou le pas de la vis-mère. Utiliser une broche de taraudage avec compensation axiale ou un mandrin de taraudage avec amortisseur axial.
	Synchronisation	Vérifier l'état du synchronisme. Éviter le taraudage rigide dans les matières à caractéristiques mécaniques élevées.
	Taraud avec entrée à hélice utilisé avec pression axiale trop faible	Réglage plus fort de la pression d'entrée (amorçage).

Problème	Causes	Solutions
Entrée de taraudage évasée	Taux d'avance incorrect	Utiliser une broche de taraudage avec compensation axiale.

Problème	Causes	Solutions
Mauvais état de surface du filetage	Mauvais choix du taraud (géométrie de coupe pas adaptée à la matière)	Vérifier le choix du type de taraud par rapport à la matière utilisée.
	Taraud émoussé	Remplacer ou réaffûter le taraud.
	Affûtage incorrect	Réaffûter l'outil encore une fois. S'assurer que la géométrie de coupe et le diamètre d'entrée sont adaptés à la matière à usiner.
	Lubrifiant ne convenant pas ou lubrification insuffisante	S'assurer de la qualité du lubrifiant et vérifier qu'il arrive jusqu'à l'arête de coupe.

PROBLEMI DI MASCHIATURA - CAUSE E SOLUZIONE

Problema	Causa	Soluzione
Scheggiatura dei denti del maschio	Truciolini bloccati	Verificare velocità di taglio. Controllare la scelta del maschio (K/N.62.-3 / Z.70VS).
	Maschio che ha urtato il fondo del foro	Controllare profondità di foratura e maschiatura. Eseguire un foro più profondo.
	Materiale con struttura irregolare	Adattare la velocità di taglio. Migliorare la qualità del lubrificante. Utilizzare il maschio con un'altra geometria di taglio / un altro rivestimento.
	Errata affilatura	Durante la riaffilatura attenersi ai parametri geometrici previsti dal costruttore.

Problema	Causa	Soluzione
Usura eccessiva	Non corretta velocità di taglio	Scegliere la giusta velocità in base al materiale da lavorare. Utilizzare un maschio con il rivestimento raccomandato.
	Lubrificante non adatto o insufficiente	Rivedere la scelta del lubrificante e garantire un flusso adeguato. Assicurarsi che i taglienti siano ben lubrificati.
	La superficie interna del foro è incrudita	Verificare la condizione di foratura del preforo (forare con attenzione per ridurre il rischio di incrudimento). Controllare lo stato dei taglienti della punta.
	Sincronizzazione	Controllare lo stato di sincronizzazione. Evitare la maschiatura rigida su materiali con elevate proprietà meccaniche.

Problema	Causa	Soluzione
Rottura del maschio	Errata scelta del maschio (geometria di taglio non adatta per l'applicazione)	Scegliere un maschio appropriato al lavoro da effettuare secondo la nostra tabella gruppi materiali DC.
	Cattiva evacuazione dei trucioli	Scegliere la geometria più adatta alla profondità di maschiatura. Se necessario, scegliere la lunghezza delle scanalature adatta.
	Errata centratura	Assicurarsi del corretto allineamento tra maschio e preforo.
	Maschio con taglienti usurati	Riaffilare il maschio. Assicurarsi che i maschi siano adeguatamente custoditi.
	Maschio che ha urtato il fondo del foro	Utilizzare un maschiatore con frizione e compensazione assiale.
	Diametro di preforatura troppo piccolo	Scegliere il diametro di preforatura seguendo la tabella nella parte tecnica di questo catalogo.

PROBLEMI DI MASCHIATURA - CAUSE E SOLUZIONE

Problema	Causa	Soluzione
Maschiatura troppo grande	Errata scelta del maschio (geometria di taglio non adatta all'applicazione)	Verificare la scelta del tipo di maschio in funzione del gruppo del materiale secondo la tabella DC.
	Errata centratura	Assicurarsi che maschio e preforo siano correttamente allineati sullo stesso asse.
	Saldature fredde	Migliorare la lubrificazione e la direzione del refrigerante. Adattare la velocità di taglio. Valutare l'uso di maschi con il trattamento o il rivestimento superficiale.
	Maschio mal riaffilato (l'imbocco conico non è concentrico)	Riaffilare l'imbocco del maschio su una macchina adeguata.

Problema	Causa	Soluzione
Filetti strappati	Errata scelta del maschio (geometria di taglio non adatta all'applicazione)	Verificare la scelta del tipo di maschio in funzione del gruppo del materiale secondo la tabella DC.
	Avanzamento del mandrino e velocità di rotazione mal sincronizzati	Controllare il valore di avanzamento e/o il passo del mandrino. Utilizzare un maschiatore con compensazione o un mandrino di maschiatura con ammortizzatore assiale.
	Sincronizzazione	Controllare lo stato di sincronizzazione. Evitare la maschiatura rigida su materiali con elevate proprietà meccaniche.
	Maschio con imbocco a elica utilizzato con pressione assiale troppo debole	Aumentare la pressione d'ingresso.

Problema	Causa	Soluzione
Imbocco della filettatura allargato	Pressione assiale applicata sul maschio non corretta	Utilizzare un maschiatore con compensazione assiale.

Problema	Causa	Soluzione
Cattivo stato superficiale dei filetti	Errata scelta del maschio (geometria di taglio non adatta all'applicazione)	Verificare la scelta del tipo di maschio in funzione del gruppo del materiale secondo la tabella DC.
	Maschio con taglienti usurati	Sostituire o riaffilare il maschio.
	Riaffilatura scadente	Riaffilare l'utensile ancora una volta. Assicurarsi che la geometria di taglio e il diametro d'imbocco siano adatti al materiale in lavorazione.
	Lubrificante insufficiente e/o di scarsa qualità	Rivedere la scelta del lubrificante e garantire un flusso adeguato.

TABELLE D'UTILISATION — TABELLA D'IMPIEGO

**Tarudage classique
Maschiatura classica**

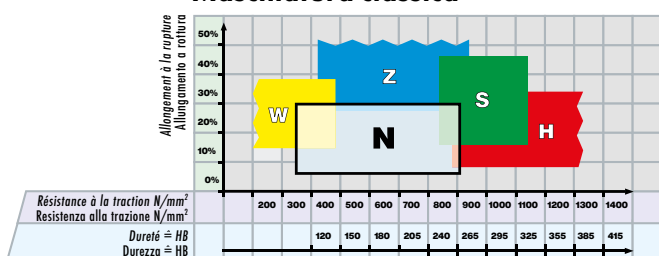

**Tarudage classique
Maschiatura classica**

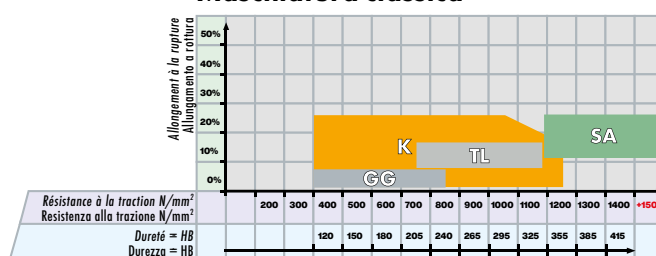

DC Classification des matières

DC Classificazione dei materiali

Groupes de matières Gruppi di materiali	Désignation des matières	Designazione dei materiali	Dureté Durezza (HB)	Résistance Resistenza Rm (N/mm ²)	Allongement Allungamento A (%)
10 Aciers Acciai	11 Aciers de décolletage	Acciai da tornitura	< 200	< 700	< 10
	12 Aciers de construction ou de cémentation	Acciai da costruzione / da cementazione	< 200	< 700	< 30
	13 Aciers au carbone	Acciai al carbonio	< 300	< 1000	< 20
	14 Aciers alliés < 850 N/mm ²	Acciai legati < 850 N/mm ²	< 250	< 850	< 30
	15 Aciers alliés / traités > 850 - < 1150 N/mm ²	Acciai legati / trattati > 850 - < 1150 N/mm ²	> 250	> 850	< 30
	16 Aciers haute résistance ≤ 44 HRC	Acciai ad alta resistenza ≤ 44 HRC	> 250	> 850	< 12
	17 Aciers améliorés > 44 - ≤ 54 HRC	Acciai bonificati > 44 - ≤ 54 HRC	> 410	> 1400	< 2
	18 Aciers trempés > 54 - ≤ 63 HRC	Acciai temprati > 54 - ≤ 63 HRC	> 560	> 1980	< 2
20 Aciers inoxydables Acciai inox	21 Aciers inoxydables, soufrés	Acciai inox, allo zolfo	< 250	< 850	< 25
	22 Austénitiques	Acciai inox, austenitici	< 250	< 850	> 20
	23 Ferritiques et martensitiques < 850 N/mm ²	Ferritici e martensitici < 850 N/mm ²	< 250	< 850	> 20
	24 Ferritiques et martensitiques > 850 - < 1150 N/mm ²	Ferritici e martensitici > 850 - < 1150 N/mm ²	> 250	> 850	> 15
30 Fonte Ghisa	31 Fonte grise	Ghisa grigia	< 250	< 850	< 10
	32 Fonte à graphite sphéroïdale et malléable	Ghisa grafitica sferoidale e malleabile	< 250	< 850	> 10
40 Titane Titanio	41 Titane pur	Titanio puro	< 250	< 850	> 20
	42 Alliage de titane	Leghe di titanio	> 250	> 850	< 20
50 Nickel Nickel	51 Alliage de nickel 1 ≤ 850 N/mm ²	Leghe di nickel 1 ≤ 850 N/mm ²	< 250	< 850	> 25
	52 Alliage de nickel 2 > 850 - ≤ 1150 N/mm ²	Leghe di nickel 2 > 850 - ≤ 1150 N/mm ²	> 250	> 850	< 25
	53 Alliage de nickel 3 > 1150 - ≤ 1600 N/mm ²	Leghe di nickel 3 > 1150 - ≤ 1600 N/mm ²	> 340	> 1150	< 20
60 Cuivre Rame	61 Cuivre pur (électrolytique)	Rame puro (elettrolitico)	< 120	< 400	> 12
	62 Laiton, bronze (copeaux courts)	Ottone, bronzo (trucioli corti)	< 200	< 700	< 12
	63 Laiton (copeaux longs)	Ottone (trucioli lunghi)	< 200	< 700	> 12
	64 Laiton sans plomb	Ottone senza piombo	< 220	< 700	> 15
70 Aluminium Magnésium Alluminio Magnesio	71 Al non allié	Alluminio non legato	< 100	< 350	> 15
	72 Al allié Si < 1.5 %	Leghe di alluminio Si < 1.5 %	< 150	< 500	> 15
	73 Al allié Si > 1.5 % - < 10 %	Leghe di alluminio Si > 1.5 % - < 10 %	< 120	< 400	< 15
	74 Al allié Si > 10 %, alliages de magnésium	Leghe di al. Si > 10 %, leghe di magnesio	< 120	< 400	< 10
80 Matières plastiques Materie plastiche	81 Matières thermoplastiques	Materie termoplastiche	-	-	-
	82 Matières duroplastiques	Materie termoindurenti	-	-	-
	83 Matières plastiques renforcées par fibres	Materie plastiche rinforzate con fibre	-	-	-
90 Métaux précieux Metalli preziosi	91 Or jaune	Oro giallo	-	-	-
	92 Or rose	Oro rosso	-	-	-
	93 Or blanc	Oro bianco	-	-	-
	94 Argent	Argento	-	-	-

TARAUDAGE CLASSIQUE — MASCHIATURA CLASSICA



Dès page : Dalla pagina:
MJ / M
MF
UNJC / UNC / UNC(J)
UNJF / UNF / UNF(J)
UNEF / UN / UNS
G / Rp / Rc / W / SV
NPT / NPTF
PG / TR
EG M / EG UNC / EG UNF

N Matières normales Materiali normali											
60	62	60	64	64	72	72	74	60	74	74	
125	124	125	125		124		131	131	131		
154	154	154	154				156	156	156		
176	176	176	176				178	178	178		
198	198						199	199			
204	205	205	205				206	206	206		
220											
222	222										
	226	226					227	227			

Vc (m/min) Guide Line						
Ø 1 - 2.8 mm		Ø 2.8 - 26 mm		Ø 26 - 60 mm		
Standard Standard	Revêtu Rivestito	Standard Standard	Revêtu Rivestito	Standard Standard	Revêtu Rivestito	
11	10 - 15	10 - 20	10 - 15	25 - 35	5 - 10	
12	10 - 15	10 - 20	10 - 15	25 - 35	5 - 10	
13	8 - 12	10 - 20	8 - 12	16 - 24	10 - 15	
14	8 - 12	10 - 20	8 - 12	16 - 24	4 - 8	
15	2 - 4	4 - 10	3 - 5	6 - 12	2 - 4	3 - 5
16		2 - 4	3 - 5	3 - 5	2 - 4	3 - 5
17			2 - 4			
18						
21	4 - 10	10 - 15	10 - 15	20 - 30	5 - 10	
22	3 - 6	4 - 8	3 - 6	6 - 12		
23	3 - 6	4 - 8	3 - 6	6 - 12		
24		3 - 5		4 - 8		3 - 5
31	10 - 15	10 - 20	10 - 15	20 - 30	5 - 10	15 - 25
32	10 - 15	10 - 20	10 - 15	20 - 30	5 - 10	
41	2 - 4	4 - 8	4 - 8	4 - 8		
42	2 - 4	3 - 5	3 - 5	3 - 5		
51		3 - 5		6 - 12		
52			4 - 8	4 - 8		
53			2 - 4			
61	8 - 12		8 - 12	12 - 16	4 - 8	
62	6 - 12	6 - 12	20 - 30	30 - 40	15 - 25	25 - 35
63	10 - 20		16 - 24		8 - 12	
64	10 - 20		16 - 24		8 - 12	
71	10 - 15	10 - 15	10 - 15	20 - 40	5 - 10	
72	10 - 20	20 - 30	20 - 30	20 - 40	10 - 15	
73	10 - 15	10 - 20	10 - 15	20 - 30	5 - 10	
74	10 - 15	10 - 20	10 - 15	20 - 30	5 - 10	
81	10 - 20		20 - 30	30 - 50	10 - 15	
82	8 - 16	16 - 24	8 - 16	16 - 24	5 - 12	10 - 15
83		6 - 12		8 - 16		5 - 12
91	12 - 20		20 - 30			
92		12 - 16		12 - 16		
93		4 - 8		4 - 8		
94		12 - 20		16 - 24		



TARAUDAGE CLASSIQUE — MASCHIATURA CLASSICA



Dès page : Dalla pagina:
MJ / M
MF
UNJC / UNC / UNC(J)
UNJF / UNF / UNF(J)
UNEF / UN / UNS
G / Rp / Rc / W / SV
NPT / NPTF
PG / TR
EG M / EG UNC / EG UNF

AÉRO							
SA Alliages spéciaux Leghe speciali			TL Alliages de titane Leghe di titanio		GG Fonte grise et fonte alu Ghisa grigia e ghisa alluminio		
47	47	46	100	47	102	102	102
140	140	139	140	140			
49	49	48	165	49			
51	51	50		51			
					207		
228	228	229	232	228			
Vc (m/min) Guide Line							
Ø 1 - 2.8 mm		Ø 2.8 - 26 mm		Ø 26 - 60 mm			
Standard Standard	Revêtu Rivestito	Standard Standard	Revêtu Rivestito	Standard Standard	Revêtu Rivestito		
11	10 - 15	10 - 20	10 - 15	25 - 35	5 - 10		
12	10 - 15	10 - 20	10 - 15	25 - 35	5 - 10		
13	8 - 12	10 - 20	8 - 12	16 - 24	10 - 15		
14	8 - 12	10 - 20	8 - 12	16 - 24	4 - 8		
15	2 - 4	4 - 10	3 - 5	6 - 12	2 - 4	3 - 5	
16		2 - 4	3 - 5	3 - 5	2 - 4	3 - 5	
17			2 - 4				
18							
21	4 - 10	10 - 15	10 - 15	20 - 30	5 - 10		
22	3 - 6	4 - 8	3 - 6	6 - 12			
23	3 - 6	4 - 8	3 - 6	6 - 12			
24		3 - 5		4 - 8		3 - 5	
31	10 - 15	10 - 20	10 - 15	20 - 30	5 - 10	15 - 25	
32	10 - 15	10 - 20	10 - 15	20 - 30	5 - 10		
41	2 - 4	4 - 8	4 - 8	4 - 8			
42	2 - 4	3 - 5	3 - 5	3 - 5			
51		3 - 5		6 - 12			
52			4 - 8	4 - 8			
53			2 - 4				
61	8 - 12		8 - 12	12 - 16	4 - 8		
62	6 - 12	6 - 12	20 - 30	30 - 40	15 - 25	25 - 35	
63	10 - 20		16 - 24		8 - 12		
64	10 - 20		16 - 24		8 - 12		
71	10 - 15	10 - 15	10 - 15	20 - 40	5 - 10		
72	10 - 20	20 - 30	20 - 30	20 - 40	10 - 15		
73	10 - 15	10 - 20	10 - 15	20 - 30	5 - 10		
74	10 - 15	10 - 20	10 - 15	20 - 30	5 - 10		
81	10 - 20		20 - 30	30 - 50	10 - 15		
82	8 - 16	16 - 24	8 - 16	16 - 24	5 - 12	10 - 15	
83		6 - 12		8 - 16		5 - 12	
91	12 - 20		20 - 30				
92		12 - 16		12 - 16			
93		4 - 8		4 - 8			
94		12 - 20		16 - 24			

TARAUDAGE CLASSIQUE ET SYNCHRONÉ MASCHIATURA CLASSICA E SINCRONA



Taroudage classique Maschiatura classica

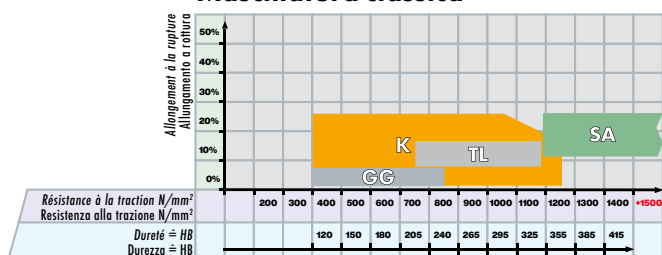

**Dès page :
Dalla pagina:**

MJ / M
MF
UNJC / UNC / UNC(J)
UNJF / UNF / UNF(J)
UNEF / UN / UNS
G / Rp / Rc / W / SV
NPT / NPTF
PG / TR
EG M / EG UNC / EG UNF

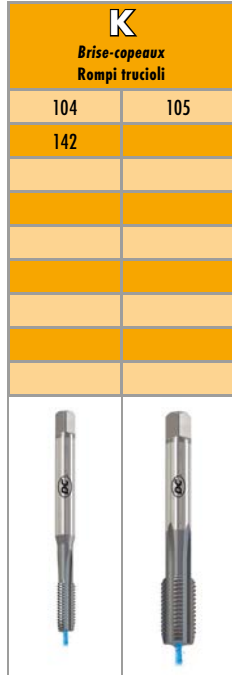

	Vc (m/min) Guide Line			
	Ø 5 - 10.9 mm	Ø 11 - 18.9 mm	Ø 19 - 31.9 mm	Ø 32 - 42 mm
	Revêtu Rivestito	Revêtu Rivestito	Revêtu Rivestito	Revêtu Rivestito
11	30 - 40	20 - 30	20 - 30	20 - 30
12	30 - 40	20 - 30	20 - 30	20 - 30
13	30 - 40	20 - 30	20 - 30	20 - 30
14	20 - 30	15 - 25	15 - 25	15 - 25
15	15 - 20	10 - 15	8 - 12	5 - 8
16	8 - 12	5 - 8	5 - 8	5 - 8
17				
18				
21				
22				
23				
24				
31	30 - 40	30 - 40	30 - 40	30 - 40
32	30 - 40	20 - 30	20 - 30	20 - 30
41				
42				
51				
52				
53				
61				
62	30 - 40	30 - 40	30 - 40	30 - 40
63	30 - 40	30 - 40	30 - 40	30 - 40
64	30 - 40	20 - 30	20 - 30	20 - 30
71				
72				
73				
74	30 - 40	30 - 40	30 - 40	30 - 40
81				
82				
83	30 - 40	30 - 40	30 - 40	30 - 40
91				
92				
93				
94				

K.13TC	K.13VS	
		11
		12
		13
		14
		15
		16
		17
		18
		21
		22
		23
		24
		31
		32
		41
		42
		51
		52
		53
		61
		62
		63
		64
		71
		72
		73
		74
		81
		82
		83
		91
		92
		93
		94

TARAUDAGE CLASSIQUE ET SYNCHRONE MASCHIATURA CLASSICA E SINCRONA



Tarudage classique et synchrone Maschiatura classica e sincrona

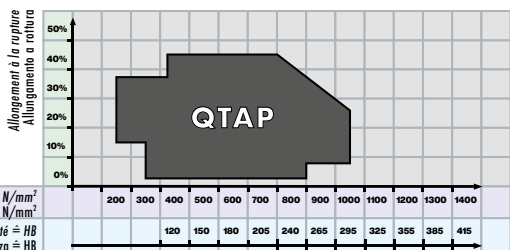

Dès page :
Dalla pagina:

MJ / M
MF
UNJC / UNC / UNC(J)
UNJF / UNF / UNF(J)
UNEF / UN / UNS
G / Rp / Rc / W / SV
NPT / NPTF
PG / TR
EG M / EG UNC / EG UNF

QTAP Allrounder Allrounder

61	106	61	107
143	143	144	144
167	167	168	168
192	192	193	193
210	210	211	211

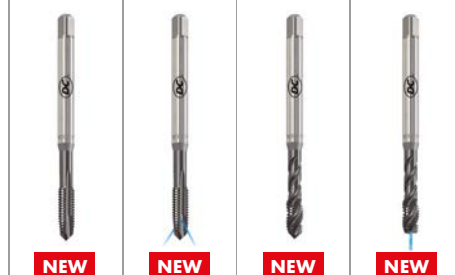

Q.20VS	Q.23VS	Q.60VS	Q.63VS

	Vc (m/min) Guide Line Ø 2.8 - 20 mm				
11	20 - 40				
12	20 - 40				
13	16 - 24				
14	16 - 24				
15	6 - 12				
16					
17					
18					
21	20 - 40				
22	6 - 12				
23	6 - 12				
24	4 - 8				
31	20 - 40				
32	20 - 40				
41					
42					
51	6 - 12				
52	4 - 8				
53					
61	12 - 16				
62	25 - 35				
63	20 - 40				
64	20 - 40				
71	20 - 40				
72	20 - 40				
73	20 - 40				
74	20 - 40				
81	20 - 40				
82	16 - 24				
83	8 - 16				
91	20 - 40				
92	12 - 16				
93					
94	12 - 16				

A Optimale avec air
Ottimale con aria

A Fonctionnelle avec air
Funzionale con aria

D Limitée
Limitato

Les valeurs ci-dessus sont indicatives.
I valori sopracitati sono indicativi.

TABELLE D'UTILISATION — TABELLA D'IMPIEGO

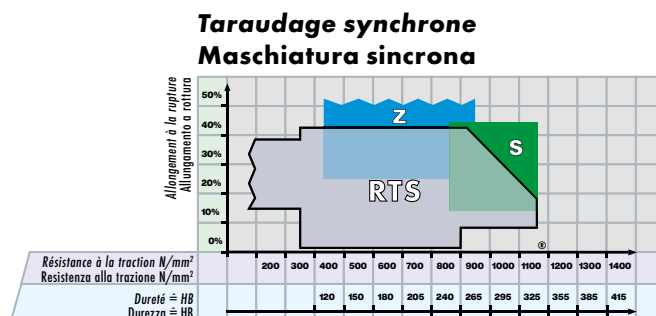

DC Classification des matières

DC Classificazione dei materiali

Groupes de matières Gruppi di materiali	Désignation des matières	Designazione dei materiali	Dureté Durezza (HB)	Résistance Resistenza Rm (N/mm ²)	Allongement Allungamento A (%)
10 Aciers Acciai	11 Aciers de décolletage	Acciai da tornitura	< 200	< 700	< 10
	12 Aciers de construction ou de cémentation	Acciai da costruzione / da cementazione	< 200	< 700	< 30
	13 Aciers au carbone	Acciai al carbonio	< 300	< 1000	< 20
	14 Aciers alliés < 850 N/mm ²	Acciai legati < 850 N/mm ²	< 250	< 850	< 30
	15 Aciers alliés / traités > 850 - < 1150 N/mm ²	Acciai legati / trattati > 850 - < 1150 N/mm ²	> 250	> 850	< 30
	16 Aciers haute résistance ≤ 44 HRC	Acciai ad alta resistenza ≤ 44 HRC	> 250	> 850	< 12
	17 Aciers améliorés > 44 - ≤ 54 HRC	Acciai bonificati > 44 - ≤ 54 HRC	> 410	> 1400	< 2
	18 Aciers trempés > 54 - ≤ 63 HRC	Acciai temprati > 54 - ≤ 63 HRC	> 560	> 1980	< 2
20 Aciers inoxydables Acciai inox	21 Aciers inoxydables, soufrés	Acciai inox, allo zolfo	< 250	< 850	< 25
	22 Austénitiques	Acciai inox, austenitici	< 250	< 850	> 20
	23 Ferritiques et martensitiques < 850 N/mm ²	Ferritici e martensitici < 850 N/mm ²	< 250	< 850	> 20
	24 Ferritiques et martensitiques > 850 - < 1150 N/mm ²	Ferritici e martensitici > 850 - < 1150 N/mm ²	> 250	> 850	> 15
30 Fonte Ghisa	31 Fonte grise	Ghisa grigia	< 250	< 850	< 10
	32 Fonte à graphite sphéroïdale et malléable	Ghisa grafitica sferoidale e malleabile	< 250	< 850	> 10
40 Titane Titanio	41 Titane pur	Titanio puro	< 250	< 850	> 20
	42 Alliage de titane	Leghe di titanio	> 250	> 850	< 20
50 Nickel Nickel	51 Alliage de nickel 1 ≤ 850 N/mm ²	Leghe di nickel 1 ≤ 850 N/mm ²	< 250	< 850	> 25
	52 Alliage de nickel 2 > 850 - ≤ 1150 N/mm ²	Leghe di nickel 2 > 850 - ≤ 1150 N/mm ²	> 250	> 850	< 25
	53 Alliage de nickel 3 > 1150 - ≤ 1600 N/mm ²	Leghe di nickel 3 > 1150 - ≤ 1600 N/mm ²	> 340	> 1150	< 20
60 Cuivre Rame	61 Cuivre pur (électrolytique)	Rame puro (elettrolitico)	< 120	< 400	> 12
	62 Laiton, bronze (copeaux courts)	Ottone, bronzo (trucioli corti)	< 200	< 700	< 12
	63 Laiton (copeaux longs)	Ottone (trucioli lunghi)	< 200	< 700	> 12
	64 Laiton sans plomb	Ottone senza piombo	< 220	< 700	> 15
70 Aluminium Magnésium Alluminio Magnesio	71 Al non allié	Alluminio non legato	< 100	< 350	> 15
	72 Al allié Si < 1.5 %	Leghe di alluminio Si < 1.5 %	< 150	< 500	> 15
	73 Al allié Si > 1.5 % - < 10 %	Leghe di alluminio Si > 1.5 % - < 10 %	< 120	< 400	< 15
	74 Al allié Si > 10 %, alliages de magnésium	Leghe di al. Si > 10 %, leghe di magnesio	< 120	< 400	< 10
80 Matières plastiques Materie plastiche	81 Matières thermoplastiques	Materie termoplastiche	-	-	-
	82 Matières duroplastiques	Materie termoindurenti	-	-	-
	83 Matières plastiques renforcées par fibres	Materie plastiche rinforzate con fibre	-	-	-
90 Métaux précieux Metalli preziosi	91 Or jaune	Oro giallo	-	-	-
	92 Or rose	Oro rosso	-	-	-
	93 Or blanc	Oro bianco	-	-	-
	94 Argent	Argento	-	-	-

TABELLE D'UTILISATION — TABELLA D'IMPIEGO

Taroudage par déformation Maschiatura per deformazione

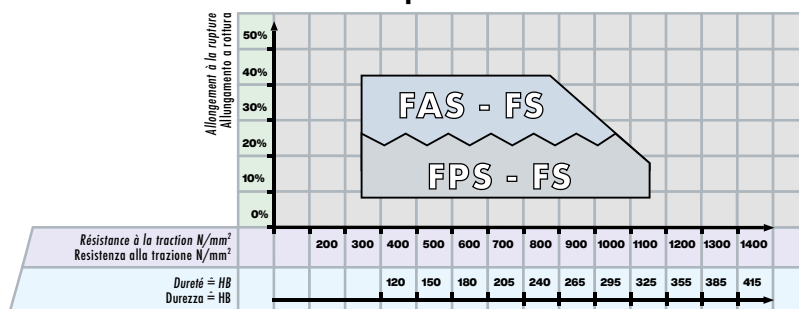

DC Classification des matières

DC Classificazione dei materiali

Groupes de matières Gruppi di materiali	Désignation des matières	Designazione dei materiali	Dureté Durezza (HB)	Résistance Resistenza Rm (N/mm²)	Allongement Allungamento A (%)
10 Aciers Acciai	11 Aciers de décolletage	Acciai da tornitura	< 200	< 700	< 10
	12 Aciers de construction ou de cémentation	Acciai da costruzione / da cementazione	< 200	< 700	< 30
	13 Aciers au carbone	Acciai al carbonio	< 300	< 1000	< 20
	14 Aciers alliés < 850 N/mm²	Acciai legati < 850 N/mm²	< 250	< 850	< 30
	15 Aciers alliés / traités > 850 - < 1150 N/mm²	Acciai legati / trattati > 850 - < 1150 N/mm²	> 250	> 850	< 30
	16 Aciers haute résistance ≤ 44 HRC	Acciai ad alta resistenza ≤ 44 HRC	> 250	> 850	< 12
	17 Aciers améliorés > 44 - ≤ 54 HRC	Acciai bonificati > 44 - ≤ 54 HRC	> 410	> 1400	< 2
	18 Aciers trempés > 54 - ≤ 63 HRC	Acciai temprati > 54 - ≤ 63 HRC	> 560	> 1980	< 2
20 Aciers inoxydables Acciai inox	21 Aciers inoxydables, soufrés	Acciai inox, allo zolfo	< 250	< 850	< 25
	22 Austénitiques	Acciai inox, austenitici	< 250	< 850	> 20
	23 Ferritiques et martensitiques < 850 N/mm²	Ferritici e martensitici < 850 N/mm²	< 250	< 850	> 20
	24 Ferritiques et martensitiques > 850 - < 1150 N/mm²	Ferritici e martensitici > 850 - < 1150 N/mm²	> 250	> 850	> 15
30 Fonte Ghisa	31 Fonte grise	Ghisa grigia	< 250	< 850	< 10
	32 Fonte à graphite sphéroïdale et malléable	Ghisa grafitica sferoidale e malleabile	< 250	< 850	> 10
40 Titane Titanio	41 Titane pur	Titanio puro	< 250	< 850	> 20
	42 Alliage de titane	Leghe di titanio	> 250	> 850	< 20
50 Nickel Nickel	51 Alliage de nickel 1 ≤ 850 N/mm²	Leghe di nickel 1 ≤ 850 N/mm²	< 250	< 850	> 25
	52 Alliage de nickel 2 > 850 - ≤ 1150 N/mm²	Leghe di nickel 2 > 850 - ≤ 1150 N/mm²	> 250	> 850	< 25
	53 Alliage de nickel 3 > 1150 - ≤ 1600 N/mm²	Leghe di nickel 3 > 1150 - ≤ 1600 N/mm²	> 340	> 1150	< 20
60 Cuivre Rame	61 Cuivre pur (électrolytique)	Rame puro (elettrolitico)	< 120	< 400	> 12
	62 Laiton, bronze (copeaux courts)	Ottone, bronzo (trucioli corti)	< 200	< 700	< 12
	63 Laiton (copeaux longs)	Ottone (trucioli lunghi)	< 200	< 700	> 12
	64 Laiton sans plomb	Ottone senza piombo	< 220	< 700	> 15
70 Aluminium Magnésium Alluminio Magnesio	71 Al non allié	Alluminio non legato	< 100	< 350	> 15
	72 Al allié Si < 1.5 %	Leghe di alluminio Si < 1.5 %	< 150	< 500	> 15
	73 Al allié Si > 1.5 % - < 10 %	Leghe di alluminio Si > 1.5 % - < 10 %	< 120	< 400	< 15
	74 Al allié Si > 10 %, alliages de magnésium	Leghe di al. Si > 10 %, leghe di magnesio	< 120	< 400	< 10
80 Matières plastiques Materie plastiche	81 Matières thermoplastiques	Materie termoplastiche	-	-	-
	82 Matières duroplastiques	Materie termoindurenti	-	-	-
	83 Matières plastiques renforcées par fibres	Materie plastiche rinforzate con fibre	-	-	-
90 Métaux précieux Metalli preziosi	91 Or jaune	Oro giallo	-	-	-
	92 Or rose	Oro rosso	-	-	-
	93 Or blanc	Oro bianco	-	-	-
	94 Argent	Argento	-	-	-

TARAUDAGE PAR DÉFORMATION MASCHIATURA PER DEFORMAZIONE



Dès page : Dalla pagina:	FS		FPS					FAS		
M	254	255	256	256	256	256	258	259	259	260
MF							262		262	
UNC	263						263		263	
UNF	264						264		264	
G							265		265	



FS.80VS	FS.80DL	FPS.80DL	FPS.81DL	FPS.80VS	FPS.81VS	FPS.84VS	FAS.80VS	FAS.81VS	FAS.84VS
----------------	----------------	-----------------	-----------------	-----------------	-----------------	-----------------	-----------------	-----------------	-----------------

V_c
(m/min)
Guide Line

Ø 1 - 2.8 mm Ø 2.8 - 20 mm

11	12 - 20	20 - 40	○ E				○ E	○ E	○ E			11
12	12 - 20	20 - 40	○ E				○ E	○ E	○ E			12
13	12 - 20	20 - 30	○ E				○ E	○ E	○ E			13
14	12 - 20	20 - 30	○ E				○ E	○ E	○ E			14
15	6 - 12	10 - 15	○					○	○			15
16												16
17												17
18												18
21	12 - 20	10 - 20	○ E	○ E				○ E	○ E	○ E		21
22	6 - 12	10 - 15	○	○ E				○ E	○ E	○ E		22
23	6 - 12	6 - 12	○	○ E				○	○ E	○ E		23
24	6 - 12	6 - 12		○				○	○ E	○ E		24
31												31
32												32
41	12 - 20	10 - 20		◐					◐	◐		41
42												42
51	6 - 12	10 - 15		○					○ E	○ E		51
52												52
53												53
61	12 - 20	10 - 20		○ E					○	○ E	○ E	61
62												62
63	12 - 20	20 - 30		○ E	○ E	○ E						63
64	12 - 20	20 - 30		○ E	○ E	○ E						64
71	12 - 20	20 - 40		○ E	○ E	○ E						71
72	12 - 20	20 - 40		○ E	○ E	○ E						72
73	12 - 20	20 - 40		○ E	○ E	○ E						73
74												74
81												81
82												82
83												83
91	12 - 20	20 - 40		○ E	○	○ E						91
92	12 - 20	20 - 40		○ E	○ E	○ E						92
93	12 - 20	20 - 40		◐	◐	◐						93
94	12 - 20	20 - 40		○ E	○ E	○ E						94

TARAUDS À MACHINE NANO
MASCHI A MACCHINA NANO

DC Classification des matières

DC Classificazione dei materiali

Groupes de matières Gruppi di materiali	Désignation des matières	Designazione dei materiali	Dureté Durezza (HB)	Résistance Resistenza Rm (N/mm ²)	Allongement Allungamento A (%)
10 Aciers Acciai	11 Aciers de décolletage	Acciai da tornitura	< 200	< 700	< 10
	12 Aciers de construction ou de cémentation	Acciai da costruzione / da cementazione	< 200	< 700	< 30
	13 Aciers au carbone	Acciai al carbonio	< 300	< 1000	< 20
	14 Aciers alliés < 850 N/mm ²	Acciai legati < 850 N/mm ²	< 250	< 850	< 30
	15 Aciers alliés / traités > 850 - < 1150 N/mm ²	Acciai legati / trattati > 850 - < 1150 N/mm ²	> 250	> 850	< 30
	16 Aciers haute résistance ≤ 44 HRC	Acciai ad alta resistenza ≤ 44 HRC	> 250	> 850	< 12
	17 Aciers améliorés > 44 - ≤ 54 HRC	Acciai bonificati > 44 - ≤ 54 HRC	> 410	> 1400	< 2
	18 Aciers trempés > 54 - ≤ 63 HRC	Acciai temprati > 54 - ≤ 63 HRC	> 560	> 1980	< 2
20 Aciers inoxydables Acciai inox	21 Aciers inoxydables, soufrés	Acciai inox, allo zolfo	< 250	< 850	< 25
	22 Austénitiques	Acciai inox, austenitici	< 250	< 850	> 20
	23 Ferritiques et martensitiques < 850 N/mm ²	Ferritici e martensitici < 850 N/mm ²	< 250	< 850	> 20
	24 Ferritiques et martensitiques > 850 - < 1150 N/mm ²	Ferritici e martensitici > 850 - < 1150 N/mm ²	> 250	> 850	> 15
30 Fonte Ghisa	31 Fonte grise	Ghisa grigia	< 250	< 850	< 10
	32 Fonte à graphite sphéroïdale et malléable	Ghisa grafitica sferoidale e malleabile	< 250	< 850	> 10
40 Titane Titanio	41 Titane pur	Titanio puro	< 250	< 850	> 20
	42 Alliage de titane	Leghe di titanio	> 250	> 850	< 20
50 Nickel Nickel	51 Alliage de nickel 1 ≤ 850 N/mm ²	Leghe di nickel 1 ≤ 850 N/mm ²	< 250	< 850	> 25
	52 Alliage de nickel 2 > 850 - ≤ 1150 N/mm ²	Leghe di nickel 2 > 850 - ≤ 1150 N/mm ²	> 250	> 850	< 25
	53 Alliage de nickel 3 > 1150 - ≤ 1600 N/mm ²	Leghe di nickel 3 > 1150 - ≤ 1600 N/mm ²	> 340	> 1150	< 20
60 Cuivre Rame	61 Cuivre pur (électrolytique)	Rame puro (elettrolitico)	< 120	< 400	> 12
	62 Laiton, bronze (copeaux courts)	Ottone, bronzo (trucioli corti)	< 200	< 700	< 12
	63 Laiton (copeaux longs)	Ottone (trucioli lunghi)	< 200	< 700	> 12
	64 Laiton sans plomb	Ottone senza piombo	< 220	< 700	> 15
70 Aluminium Magnésium Alluminio Magnesio	71 Al non allié	Alluminio non legato	< 100	< 350	> 15
	72 Al allié Si < 1.5 %	Leghe di alluminio Si < 1.5 %	< 150	< 500	> 15
	73 Al allié Si > 1.5 % - < 10 %	Leghe di alluminio Si > 1.5 % - < 10 %	< 120	< 400	< 15
	74 Al allié Si > 10 %, alliages de magnésium	Leghe di al. Si > 10 %, leghe di magnesio	< 120	< 400	< 10
80 Matières plastiques Materie plastiche	81 Matières thermoplastiques	Materie termoplastiche	-	-	-
	82 Matières duroplastiques	Materie termoindurenti	-	-	-
	83 Matières plastiques renforcées par fibres	Materie plastiche rinforzate con fibre	-	-	-
90 Métaux précieux Metalli preziosi	91 Or jaune	Oro giallo	-	-	-
	92 Or rose	Oro rosso	-	-	-
	93 Or blanc	Oro bianco	-	-	-
	94 Argent	Argento	-	-	-

TARAUDS À REFOULER NANO
MASCHI A RULLARE NANO

DC Classification des matières

DC Classificazione dei materiali

Groupes de matières Gruppi di materiali	Désignation des matières	Designazione dei materiali	Dureté Durezza (HB)	Résistance Resistenza Rm (N/mm ²)	Allongement Allungamento A (%)
10 Aciers Acciai	11 Aciers de décolletage	Acciai da tornitura	< 200	< 700	< 10
	12 Aciers de construction ou de cémentation	Acciai da costruzione / da cementazione	< 200	< 700	< 30
	13 Aciers au carbone	Acciai al carbonio	< 300	< 1000	< 20
	14 Aciers alliés < 850 N/mm ²	Acciai legati < 850 N/mm ²	< 250	< 850	< 30
	15 Aciers alliés / traités > 850 - < 1150 N/mm ²	Acciai legati / trattati > 850 - < 1150 N/mm ²	> 250	> 850	< 30
	16 Aciers haute résistance ≤ 44 HRC	Acciai ad alta resistenza ≤ 44 HRC	> 250	> 850	< 12
	17 Aciers améliorés > 44 - ≤ 54 HRC	Acciai bonificati > 44 - ≤ 54 HRC	> 410	> 1400	< 2
	18 Aciers trempés > 54 - ≤ 63 HRC	Acciai temprati > 54 - ≤ 63 HRC	> 560	> 1980	< 2
20 Aciers inoxydables Acciai inox	21 Aciers inoxydables, soufrés	Acciai inox, allo zolfo	< 250	< 850	< 25
	22 Austénitiques	Acciai inox, austenitici	< 250	< 850	> 20
	23 Ferritiques et martensitiques < 850 N/mm ²	Ferritici e martensitici < 850 N/mm ²	< 250	< 850	> 20
	24 Ferritiques et martensitiques > 850 - < 1150 N/mm ²	Ferritici e martensitici > 850 - < 1150 N/mm ²	> 250	> 850	> 15
30 Fonte Ghisa	31 Fonte grise	Ghisa grigia	< 250	< 850	< 10
	32 Fonte à graphite sphéroïdale et malléable	Ghisa grafitica sferoidale e malleabile	< 250	< 850	> 10
40 Titane Titanio	41 Titane pur	Titanio puro	< 250	< 850	> 20
	42 Alliage de titane	Leghe di titanio	> 250	> 850	< 20
50 Nickel Nickel	51 Alliage de nickel 1 ≤ 850 N/mm ²	Leghe di nickel 1 ≤ 850 N/mm ²	< 250	< 850	> 25
	52 Alliage de nickel 2 > 850 - ≤ 1150 N/mm ²	Leghe di nickel 2 > 850 - ≤ 1150 N/mm ²	> 250	> 850	< 25
	53 Alliage de nickel 3 > 1150 - ≤ 1600 N/mm ²	Leghe di nickel 3 > 1150 - ≤ 1600 N/mm ²	> 340	> 1150	< 20
60 Cuivre Rame	61 Cuivre pur (électrolytique)	Rame puro (elettrolitico)	< 120	< 400	> 12
	62 Laiton, bronze (copeaux courts)	Ottone, bronzo (trucioli corti)	< 200	< 700	< 12
	63 Laiton (copeaux longs)	Ottone (trucioli lunghi)	< 200	< 700	> 12
	64 Laiton sans plomb	Ottone senza piombo	< 220	< 700	> 15
70 Aluminium Magnésium Alluminio Magnesio	71 Al non allié	Alluminio non legato	< 100	< 350	> 15
	72 Al allié Si < 1.5 %	Leghe di alluminio Si < 1.5 %	< 150	< 500	> 15
	73 Al allié Si > 1.5 % - < 10 %	Leghe di alluminio Si > 1.5 % - < 10 %	< 120	< 400	< 15
	74 Al allié Si > 10 %, alliages de magnésium	Leghe di al. Si > 10 %, leghe di magnesio	< 120	< 400	< 10
80 Matières plastiques Materie plastiche	81 Matières thermoplastiques	Materie termoplastiche	-	-	-
	82 Matières duroplastiques	Materie termoindurenti	-	-	-
	83 Matières plastiques renforcées par fibres	Materie plastiche rinforzate con fibre	-	-	-
90 Métaux précieux Metalli preziosi	91 Or jaune	Oro giallo	-	-	-
	92 Or rose	Oro rosso	-	-	-
	93 Or blanc	Oro bianco	-	-	-
	94 Argent	Argento	-	-	-

TARAUDS À REFOULER NANO — MASCHI A RULLARE NANO



Dès page :
Dalla pagina:
M
MF
UNC
UNF
S
SF
SL

FA		CFA	
Matières normales Materiali normali		Matériaux non-ferreux Materiali non ferrosi	
363	363	370	370
364	364		
365	365	371	371
366	366	372	372
367	367	373	373
368	368		
369	369		
FA80VS	FA83VS	CFA80VS	CFA83VS

	Vc (m/min) Guide Line					
	Ø 0.3 - 1.4 mm	Ø 1.4 - 2.8 mm				
	Revêtu Rivestito	Revêtu Rivestito				
11	4 - 10	12 - 20				11
12	4 - 10	12 - 20				12
13	4 - 10	12 - 20				13
14	4 - 10	12 - 20				14
15	3 - 6	6 - 12				15
16						16
17						17
18						18
21	4 - 10	12 - 20				21
22	3 - 6	6 - 12				22
23	3 - 6	6 - 12				23
24	3 - 6	6 - 12				24
31						31
32						32
41						41
42						42
51	3 - 6	6 - 12				51
52						52
53						53
61	4 - 10	12 - 20				61
62	4 - 10	12 - 20				62
63	4 - 10	12 - 20				63
64	4 - 10	12 - 20				64
71	4 - 10	12 - 20				71
72	4 - 10	12 - 20				72
73	4 - 10	12 - 20				73
74						74
81						81
82						82
83						83
91	4 - 10	12 - 20				91
92	4 - 10	12 - 20				92
93	4 - 10	12 - 20				93
94	4 - 10	12 - 20				94

CONCEPTION DE LA CONSTRUCTION DES TARAUDS ESECUZIONE COSTRUTTIVO DEI MASCHI PER FILETTARE

		Conception selon ISO / DIN Dimensions générales	Esecuzione secondo ISO / DIN Dimensioni generali
ISO 529 DIN 5157 (G)	N1110-. / N1210-. N210-. (G)	<i>Tarauds à main avec diamètre sur flancs étagés</i>	Maschi a mano con step diametrali
ISO 529 DIN 5157 (G)	N1110-3 / N1210-3 N1120-4 / N1220-4 N1160-3 / N1260-3 N210-3 / N220-4 (G)	<i>Tarauds à machine courts</i>	Maschi a macchina corti
DIN 352	NP110-S NP210-S	<i>Tarauds à main avec diamètre sur flancs étagés, ébaucheur -1 avec pilote de guidage</i>	Maschi a mano con step diametrali, sgrossatori -1 con guida pilota
DIN 371	N3.; W3.; Z3.; H3.; S3.; SA3.; TL3.; GG3.; K3.; Q3.; RTS3.;	<i>Tarauds à machine avec queue DIN renforcée</i>	Maschi a macchina con gambo DIN rinforzato
DIN 376 / DIN 374 / DIN 5156 (G)	N4.; W4.; Z4.; H4.; S4.; SA4.; TL4.; GG4.; K4.; Q4.; RTS4.;	<i>Tarauds à machine avec queue DIN passante</i>	Maschi a macchina con gambo DIN passante

		Conception selon normes d'usine DC Dimensions générales	Esecuzione secondo lo standard di fabbrica DC Dimensioni generali
DC	K613	<i>Tarauds à machine extra-longs avec rainures longues et queue DIN passante</i>	Maschi a macchina extra-lunghi con scanalature lunghe e gambo passante DIN
DC / DIN 371	N5.; GG5.; RTS5.;	<i>Tarauds à machine extra-longs avec queue DIN renforcée Longueur totale selon norme d'usine DC, dimensions de la queue selon DIN 371</i>	Maschi a macchina extra-lunghi con gambo DIN rinforzato Lunghezza totale secondo lo stan- dard di fabbrica DC, dimensioni del gambo secondo DIN 371
DC / DIN 376	N6.; GG6.; RTS6.; K6.;	<i>Tarauds à machine extra-longs avec queue DIN passante Longueur totale selon norme d'usine DC, dimensions de la queue selon DIN 376</i>	Maschi a macchina extra-lunghi con gambo DIN passante Lunghezza totale secondo lo stan- dard di fabbrica DC, dimensioni del gambo secondo DIN 376
DC	N470V-	<i>Tarauds couronne</i>	Maschi a corona
DC	N5951 / N5952	<i>Forets-taraudeurs</i>	Punte maschiatrici

CONCEPTION DE LA CONSTRUCTION DES TARAUDS À REFOULER ESECUZIONE COSTRUTTIVO DEI MASCHI A RULLARE

		Conception selon DIN Dimensions générales	Esecuzione secondo DIN Dimensioni generali
~ DIN 2174 (M - MF) ~ DIN 2184-1 (UNC - UNF)	FS3.; FAS3.; FPS3.;	<i>Tarauds à refoiler avec queue DIN renforcée</i>	Maschi a rullare con gambo DIN rinforzato
~ DIN 2174 (M - MF) ~ DIN 2184-1 (UNC - UNF) ~ DIN 2189 (G)	FAS4.; FPS4.;	<i>Tarauds à refoiler avec queue DIN passante</i>	Maschi a rullare con gambo DIN passante

		Conception selon normes d'usine DC Dimensions générales	Esecuzione secondo lo standard di fabbrica DC Dimensioni generali
DC / ~ DIN 2174	FAS5.; FPS5.;	<i>Tarauds à refoiler extra-longs avec queue DIN renforcée Longueur totale selon norme d'usine DC, dimensions de la queue selon DIN 2174</i>	Maschi a rullare extra-lunghi con gambo DIN rinforzato Lunghezza totale secondo lo stan- dard di fabbrica DC, dimensioni del gambo secondo DIN 2174
DC / ~ DIN 2174	FAS6.; FPS6.;	<i>Tarauds à refoiler extra-longs avec queue DIN passante Longueur totale selon norme d'usine DC, dimensions de la queue selon DIN 2174</i>	Maschi a rullare extra-lunghi con gambo DIN passante Lunghezza totale secondo lo stan- dard di fabbrica DC, dimensioni del gambo secondo DIN 2174

TABELLE DE DURETÉ — TABELLA DI DUREZZA

HRC <i>Dureté Rockwell</i> Durezza Rockwell	HB <i>Dureté Brinell</i> Durezza Brinell	HV <i>Dureté Vickers</i> Durezza Vickers	N/mm² Mpa <i>Résistance à la traction</i> Resistenza a la trazione
25	253	266	854
26	259	273	873
27	265	279	897
28	272	286	919
29	279	294	944
30	287	302	970
31	295	310	995
32	303	318	1024
33	311	327	1052
34	320	336	1082
35	328	345	1111
36	337	355	1139
37	346	364	1168
38	354	373	1198
39	363	382	1227
40	373	392	1262
41	382	402	1296
42	392	412	1327
43	402	423	1362
44	413	434	1401
45	424	446	1442
46	436	459	1481
47	448	471	1524
48	460	484	1572
49	474	499	1625
50	488	513	1675
51	502	528	1733
52	518	545	1793
53	532	560	1845
54	549	578	1912
55	566	596	1979
56	585	615	2050
57	603	634	2121
58	621	654	2200
59		675	
60		698	
61		720	
62		746	
63		773	

Table de conversion pour valeurs de dureté, extrait de la norme ISO EN 18265;2003, anciennement DIN 50150. Valeurs arrondies.
Tabella di conversione per il valore di durezza, estratto da ISO EN 18265; 2003 / precedentemente DIN 50150. Valori arrotondati.

POUCES-MM — POLLICI-MM

Ø" d ₁	Ø mm	TPI UN											W(BSW)	BSF	G (BSP) Rp	Ø mm	
		UNC	UNF	UNEF	4	6	8	12	16	20	28	32					
0 1/16"	1.52 1.59		80											48		28	7.72
1 2 3/32"	1.85 2.18 2.38	64 56	72 64														
3 4 5 1/8"	2.51 2.84 3.17 3.17	48 40 40	56 48 44											40		28	9.72
6 5/32"	3.50	32	40											32			
8 3/16"	3.96 4.16 4.76	32	36											24	32		
10 12	4.82 5.48	24 24	32 28	32													
7/32"	5.55													24			
1/4"	6.35	20	28	32										20	28	19	13.15
9/32"	7.14														26		
5/16"	7.93	18	24	32					20	28					26		
3/8"	9.52	16	24	32					20	28				16	20	19	16.66
7/16"	11.11	14	20	28					16					14	18		
1/2"	12.70	13	20	28					16					12	16	14	20.95
9/16"	14.28	12	18	24					16	20	28			12	16		
5/8"	15.87	11	18	24				12	16	20	28			11	14	14	22.91
11/16"	17.46			24				12	16	20	28			11	14		
3/4"	19.05	10	16	20				12			28	32		10	12	14	26.44
13/16"	20.64			20				12	16		28	32			12		
7/8"	22.22	9	14	20				12	16		28	32		9	11	14	30.20
15/16"	23.81			20				12	16		28	32			11		
1"	25.40	8	12	20				12	16		28	32		8	10	11	33.24
11/16"	26.99			18			8	12	16	20	28						
11/8"	28.57	7	12	18			8	12	16	20	28			7	9	11	37.89
13/16"	30.16			18			8	12	16	20	28						
11/4"	31.75	7	12	18			8	12	16	20	28			7	9	11	41.91
15/16"	33.34			18			8	12	16	20	28						
13/8"	34.92	6	12	18			8	12	16	20	28			6	8	11	44.32
17/16"	36.51			18			8	12	16	20	28						
11/2"	38.10	6	12	18		6	8	12	16	20	28			6	8	11	47.80
19/16"	39.69			18		6	8	12	16	20							
15/8"	41.28			18		6	8	12	16	20				5	8		
111/16"	42.86			18													
13/4"	44.45	5				6	8	12	16	20				5	7	11	53.74
113/16"	46.04					6	8	12	16	20							
17/8"	47.63					6	8	12	16	20				4 1/2			
115/16"	49.21					6	8	12	16	20							
2"	50.80	4 1/2												4 1/2	7	11	59.61
21/8"	53.97					6	8	12	16	20							
21/4"	57.15	4 1/2				6	8	12	16	20				4	6	11	65.71
23/8"	60.32					6	8	12	16	20							
21/2"	63.50	4				6	8	12	16	20				4	6	11	75.18
25/8"	66.67				4	6	8	12	16	20							
23/4"	69.85	4				6	8	12	16	20				3 1/2	6	11	81.53
27/8"	73.02				4	6	8	12	16	20							
3"	76.20	4				6	8	12	16	20				3 1/2	5	11	87.88
31/8"	79.37				4	6	8	12	16								
31/4"	82.55	4				6	8	12	16					3 1/4	5	11	93.98
33/8"	85.72				4	6	8	12	16								
31/2"	88.90	4				6	8	12	16					3 1/4	4 1/2	11	100.33
35/8"	92.07				4	6	8	12	16								
33/4"	95.25	4				6	8	12	16					3	4 1/2	11	106.68
37/8"	98.42				4	6	8	12	16								
4"	101.60	4				6	8	12	16					3	4 1/2	11	113.03

TABELLE DE CONVERSION – TABELLA DI CONVERSIONE

		Vc m/min															
		1	2	3	4	5	6	8	10	12	15	20	25	30	40	50	60
		min ⁻¹															
Ø d ₁	1	318	637	955	1273	1592	1910	2546	3183	3820	4775	6366	7958	9549	12732	15915	19099
	2	159	318	477	637	796	955	1273	1592	1910	2387	3183	3979	4775	6366	7958	9549
	3	106	212	318	424	531	637	849	1061	1273	1592	2122	2653	3183	4244	5305	6366
	4	80	159	239	318	398	477	637	796	955	1194	1592	1989	2387	3183	3979	4775
	5	64	127	191	255	318	382	509	637	764	955	1273	1592	1910	2546	3183	3820
	6	53	106	159	212	265	318	424	531	637	796	1061	1326	1592	2122	2653	3183
	8	40	80	119	159	199	239	318	398	477	597	796	995	1194	1592	1989	2387
	10	32	64	95	127	159	191	255	318	382	477	637	796	955	1273	1592	1910
	12	27	53	80	106	133	159	212	265	318	398	531	663	796	1061	1326	1592
	14	23	45	68	91	114	136	182	227	273	341	455	568	682	909	1137	1364
	16	20	40	60	80	99	119	159	199	239	298	398	497	597	796	995	1194
	18	18	35	53	71	88	106	141	177	212	265	354	442	531	707	884	1061
	20	16	32	48	64	80	95	127	159	191	239	318	398	477	637	796	955
	25	13	25	38	51	64	76	102	127	153	191	255	318	382	509	637	764
	30	11	21	32	42	53	64	85	106	127	159	212	265	318	424	531	637
	35	9	18	27	36	45	55	73	91	109	136	182	227	273	364	455	546
	40	8	16	24	32	40	48	64	80	95	119	159	199	239	318	398	477
45	7	14	21	28	35	42	57	71	85	106	141	177	212	283	354	424	
50	6	13	19	25	32	38	51	64	76	95	127	159	191	255	318	382	

PERÇAGE D'AVANT-TROUS — PREFORI PER FILETTARE

M ISO DIN 14 4H5H (recommandé / consigliato)

Ø	P	Ø Noyau - Ø Nocciolo		Ø guide line
		Ø mini	Ø maxi	
d ₁	mm			
0.3	0.080	0.223	0.240	0.23
0.35	0.090	0.264	0.286	0.28
0.4	0.100	0.304	0.330	0.32
0.5	0.125	0.380	0.415	0.41
0.6	0.150	0.456	0.502	0.50
0.7	0.175	0.532	0.585	0.58
0.8	0.200	0.608	0.665	0.66
0.9	0.225	0.684	0.745	0.74



MF DIN 13, ISO 261, *4H / 6H

Ø	P	Ø Noyau - Ø Nocciolo		Ø guide line
		Ø mini	Ø maxi	
d ₁	mm			
*1.4	0.20	1.183	1.221	1.20
*1.6	0.20	1.383	1.421	1.40
*1.8	0.20	1.583	1.621	1.60
*2	0.20	1.783	1.821	1.80
*2	0.25	1.729	1.774	1.75
*2.2	0.20	1.983	2.021	2.00
*2.2	0.25	1.929	1.974	1.95
*2.3	0.20	2.083	2.121	2.10
*2.3	0.25	2.029	2.074	2.05
*2.5	0.20	2.283	2.321	2.30
*2.5	0.25	2.229	2.274	2.25
2.5	0.35	2.121	2.221	2.15
2.6	0.35	2.221	2.321	2.25
3	0.35	2.621	2.721	2.65
3.5	0.35	3.121	3.221	3.15
4	0.50	3.459	3.599	3.50
4.5	0.50	3.959	4.099	4.00
5	0.50	4.459	4.599	4.50
5.5	0.50	4.959	5.099	5.00
6	0.75	5.188	5.378	5.25
7	0.75	6.188	6.378	6.25
8	0.75	7.188	7.378	7.25
8	1.00	6.917	7.153	7.00
9	0.75	8.188	8.378	8.25
9	1.00	7.917	8.153	8.00
10	0.75	9.188	9.378	9.25
10	1.00	8.917	9.153	9.00
10	1.25	8.647	8.912	8.80
11	0.75	10.188	10.378	10.25
11	1.00	9.917	10.153	10.00
12	1.00	10.917	11.153	11.00
12	1.25	10.647	10.912	10.80
12	1.50	10.376	10.676	10.50
14	1.00	12.917	13.153	13.00
14	1.25	12.647	12.912	12.80
14	1.50	12.376	12.676	12.50
15	1.00	13.917	14.153	14.00
15	1.50	13.376	13.676	13.50
16	1.00	14.917	15.153	15.00
16	1.50	14.376	14.676	14.50
17	1.00	15.917	16.153	16.00
17	1.50	15.376	15.676	15.50
18	1.00	16.917	17.153	17.00
18	1.50	16.376	16.676	16.50
18	2.00	15.835	16.210	16.00
20	1.00	18.917	19.153	19.00
20	1.50	18.376	18.676	18.50
20	2.00	17.835	18.210	18.00
22	1.00	20.917	21.153	21.00
22	1.50	20.376	20.676	20.50
22	2.00	19.835	20.210	20.00
24	1.00	22.917	23.153	23.00
24	1.50	22.376	22.676	22.50
24	2.00	21.835	22.210	22.00
25	1.00	23.917	24.153	24.00
25	1.50	23.376	23.676	23.50
25	2.00	22.835	23.210	23.00



M DIN 13, ISO 261, *5H / 6H

Ø	P	Ø Noyau - Ø Nocciolo		Ø guide line
		Ø mini	Ø maxi	
d ₁	mm			
*1	0.25	0.729	0.785	0.75
*1.1	0.25	0.829	0.885	0.85
*1.2	0.25	0.929	0.985	0.95
*1.4	0.30	1.075	1.142	1.10
1.6	0.35	1.221	1.321	1.25
1.7	0.35	1.321	1.421	1.35
1.8	0.35	1.421	1.521	1.45
2	0.40	1.567	1.679	1.60
2.2	0.45	1.713	1.838	1.75
2.3	0.40	1.867	1.979	1.90
2.5	0.45	2.013	2.138	2.05
2.6	0.45	2.113	2.238	2.15
3	0.50	2.459	2.599	2.50
3.5	0.60	2.850	3.010	2.90
4	0.70	3.242	3.422	3.30
4.5	0.75	3.688	3.878	3.75
5	0.80	4.134	4.334	4.20
6	1.00	4.917	5.153	5.00
7	1.00	5.917	6.153	6.00
8	1.25	6.647	6.912	6.80
9	1.25	7.647	7.912	7.80
10	1.50	8.376	8.676	8.50
11	1.50	9.376	9.676	9.50
12	1.75	10.106	10.441	10.20
14	2.00	11.835	12.210	12.00
16	2.00	13.835	14.210	14.00
18	2.50	15.294	15.744	15.50
20	2.50	17.294	17.744	17.50
22	2.50	19.294	19.744	19.50
24	3.00	20.752	21.252	21.00
27	3.00	23.752	24.252	24.00
30	3.50	26.211	26.771	26.50
33	3.50	29.211	29.771	29.50
36	4.00	31.670	32.270	32.00
39	4.00	34.670	35.270	35.00
42	4.50	37.129	37.799	37.50
45	4.50	40.129	40.799	40.50
48	5.00	42.587	43.297	43.00
52	5.00	46.587	47.297	47.00
56	5.50	50.046	50.796	50.50



PERÇAGE D'AVANT-TROUS — PREFORI PER FILETTARE

MF DIN 13, ISO 261, 6H

Ø	P	Ø Noyau - Ø Nocciole		Ø guide line
		Ø mini	Ø maxi	
d ₁	mm			
27	1.50	25.376	25.676	25.50
27	2.00	24.835	25.210	25.00
28	1.00	26.917	27.153	27.00
28	1.50	26.376	26.676	26.50
28	2.00	25.835	26.210	26.00
30	1.00	28.917	29.153	29.00
30	1.50	28.376	28.676	28.50
30	2.00	27.835	28.210	28.00
32	1.50	30.376	30.676	30.50
32	2.00	29.835	30.210	30.00
33	1.50	31.376	31.676	31.50
33	2.00	30.835	31.210	31.00
35	1.50	33.376	33.676	33.50
36	1.50	34.376	34.676	34.50
36	2.00	33.835	34.210	34.00
36	3.00	32.752	33.252	33.00
39	1.50	37.376	37.676	37.50
39	2.00	36.835	37.210	37.00
39	3.00	35.752	36.252	36.00
40	1.50	38.376	38.676	38.50
40	2.00	37.835	38.210	38.00
40	3.00	36.752	37.252	37.00
42	1.50	40.376	40.676	40.50
42	2.00	39.835	40.210	40.00
42	3.00	38.752	39.252	39.00
45	1.50	43.376	43.676	43.50
45	2.00	42.835	43.210	43.00
45	3.00	41.752	42.252	42.00
48	1.50	46.376	46.676	46.50
48	2.00	45.835	46.210	46.00
48	3.00	44.752	45.252	45.00
50	1.50	48.376	48.676	48.50
50	2.00	47.835	48.210	48.00
50	3.00	46.752	47.252	47.00
52	1.50	50.376	50.676	50.50
52	2.00	49.835	50.210	50.00
52	3.00	48.752	49.252	49.00
55	2.00	52.835	53.210	53.00
60	2.00	57.835	58.210	58.00

MF EN 60423:1994, 7H

Ø	P	Ø Noyau - Ø Nocciole		Ø guide line
		Ø mini	Ø maxi	
d ₁	mm			
8	1.00	6.917	7.217	7.00
10	1.00	8.917	9.217	9.00
12	1.50	10.376	10.751	10.50
16	1.50	14.376	14.751	14.50
20	1.50	18.376	18.751	18.50
25	1.50	23.376	23.751	23.50
32	1.50	30.376	30.751	30.50
40	1.50	38.376	38.751	38.50
63	1.50	61.376	61.751	61.50

UNC ASME B1.1, 2B

Ø"	P	P	Ø Noyau - Ø Nocciole		Ø guide line
			Ø mini	Ø maxi	
d ₁	TPI	mm			
1	64	0.397	1.425	1.582	1.45
2	56	0.454	1.695	1.871	1.75
3	48	0.529	1.941	2.146	2.00
4	40	0.635	2.157	2.385	2.25
5	40	0.635	2.487	2.697	2.55
6	32	0.794	2.642	2.895	2.75
8	32	0.794	3.302	3.530	3.40
10	24	1.058	3.683	3.962	3.80
12	24	1.058	4.344	4.597	4.40
1/4"	20	1.270	4.979	5.257	5.10
5/16"	18	1.411	6.401	6.731	6.50
3/8"	16	1.588	7.798	8.153	8.00
7/16"	14	1.814	9.144	9.550	9.30
1/2"	13	1.954	10.592	11.023	10.80
9/16"	12	2.117	11.989	12.446	12.20
5/8"	11	2.309	13.386	13.868	13.60
3/4"	10	2.540	16.307	16.840	16.60
7/8"	9	2.822	19.177	19.761	19.50
1"	8	3.175	21.971	22.606	22.30
1 1/8"	7	3.629	24.638	25.349	25.00
1 1/4"	7	3.629	27.813	28.524	28.20
1 3/8"	6	4.233	30.353	31.115	30.80
1 1/2"	6	4.233	33.528	34.290	34.00
1 3/4"	5	5.080	38.964	39.827	39.50
2"	4.5	5.644	44.679	45.593	45.30

UNJC ISO 3161:1999, 3B

Ø"	P	P	Ø Noyau - Ø Nocciole		Ø guide line
			Ø mini	Ø maxi	
d ₁	TPI	mm			
4	40	0.635	2.228	2.393	2.30
5	40	0.635	2.558	2.723	2.60
6	32	0.794	2.733	2.939	2.80
8	32	0.794	3.393	3.599	3.45
10	24	1.058	3.795	4.064	3.90
12	24	1.058	4.455	4.704	4.55
1/4"	20	1.270	5.113	5.387	5.20
5/16"	18	1.411	6.563	6.833	6.70
3/8"	16	1.588	7.978	8.255	8.10
7/16"	14	1.814	9.347	9.639	9.40
1/2"	13	1.954	10.798	11.095	10.90
9/16"	12	2.117	12.228	12.482	12.40
5/8"	11	2.309	13.627	13.904	13.80
3/4"	10	2.540	16.576	16.881	16.70

PERÇAGE D'AVANT-TROUS — PREFORI PER FILETTARE

UNF ASME B1.1, 2B

Ø"	P	P	Ø Noyau - Ø Nocciolo		
d ₁	TPI	mm	Ø mini	Ø maxi	Ø guide line
0	80	0.318	1.182	1.305	1.20
1	72	0.353	1.474	1.612	1.50
2	64	0.397	1.756	1.912	1.80
3	56	0.454	2.025	2.197	2.10
4	48	0.529	2.271	2.458	2.35
5	44	0.577	2.551	2.740	2.60
6	40	0.635	2.820	3.022	2.90
8	36	0.706	3.404	3.606	3.50
10	32	0.794	3.963	4.165	4.05
12	28	0.907	4.496	4.724	4.60
1/4"	28	0.907	5.360	5.588	5.50
5/16"	24	1.058	6.782	7.035	6.90
3/8"	24	1.058	8.382	8.636	8.50
7/16"	20	1.270	9.729	10.033	9.80
1/2"	20	1.270	11.329	11.607	11.40
9/16"	18	1.411	12.751	13.081	12.90
5/8"	18	1.411	14.351	14.681	14.50
3/4"	16	1.588	17.323	17.678	17.50
7/8"	14	1.814	20.270	20.675	20.40
1"	12	2.117	23.114	23.571	23.30
1 1/8"	12	2.117	26.289	26.746	26.50
1 1/4"	12	2.117	29.464	29.921	29.70
1 3/8"	12	2.117	32.639	33.096	32.80
1 1/2"	12	2.117	35.814	36.271	36.00

UNJF ISO 3161:1999, 3B

Ø"	P	P	Ø Noyau - Ø Nocciolo		
d ₁	TPI	mm	Ø mini	Ø maxi	Ø guide line
0	80	0.318	1.217	1.298	1.25
1	72	0.353	1.511	1.603	1.55
2	64	0.397	1.798	1.902	1.85
3	56	0.454	2.073	2.189	2.10
4	48	0.529	2.329	2.466	2.35
5	44	0.577	2.614	2.764	2.65
6	40	0.635	2.888	3.053	2.95
8	36	0.706	3.480	3.663	3.55
10	32	0.794	4.054	4.255	4.10
12	28	0.907	4.602	4.816	4.70
1/4"	28	0.907	5.466	5.662	5.55
5/16"	24	1.058	6.906	7.109	7.00
3/8"	24	1.058	8.494	8.679	8.60
7/16"	20	1.270	9.876	10.084	10.00
1/2"	20	1.270	11.463	11.661	11.55
9/16"	18	1.411	12.913	13.122	13.05
5/8"	18	1.411	14.501	14.702	14.60
3/4"	16	1.588	17.506	17.722	17.60
7/8"	14	1.814	20.460	20.706	20.60
1"	12	2.117	23.340	23.594	23.50

UNEF ASME B1.1, 2B

Ø"	P	P	Ø Noyau - Ø Nocciolo		
d ₁	TPI	mm	Ø mini	Ø maxi	Ø guide line
12	32	0.794	4.623	4.826	4.70
1/4"	32	0.794	5.487	5.689	5.60
5/16"	32	0.794	7.087	7.264	7.20
3/8"	32	0.794	8.662	8.864	8.75
7/16"	28	0.907	10.135	10.337	10.25
1/2"	28	0.907	11.710	11.938	11.85
9/16"	24	1.058	13.132	13.385	13.20
5/8"	24	1.058	14.732	14.986	14.80
11/16"	24	1.058	16.307	16.560	16.40
3/4"	20	1.270	17.679	17.957	17.80
13/16"	20	1.270	19.254	19.558	19.40
7/8"	20	1.270	20.854	21.132	21.00
1"	20	1.270	24.029	24.307	24.10

UN ASME B1.1, 2B

Ø"	P	P	Ø Noyau - Ø Nocciolo		
d ₁	TPI	mm	Ø mini	Ø maxi	Ø guide line
5/16"	20	1.270	6.554	6.858	6.70
3/8"	20	1.270	8.154	8.432	8.30
9/16"	20	1.270	12.904	13.208	13.00
5/8"	20	1.270	14.504	14.782	14.60
1 1/8"	8	3.175	25.146	25.781	25.50
1 1/4"	8	3.175	28.321	28.956	28.70
1 3/8"	8	3.175	31.496	32.131	31.80
1 1/2"	8	3.175	34.671	35.306	35.00
1 5/8"	8	3.175	37.846	38.481	38.20
1 3/4"	8	3.175	41.021	41.656	41.40
1 7/8"	8	3.175	44.196	44.831	44.50
2"	8	3.175	47.371	48.006	47.70
2 1/4"	8	3.175	53.721	54.356	54.10
2 1/2"	8	3.175	60.071	60.706	60.40

UNS ASME B1.1, 2B

Ø"	P	P	Ø Noyau - Ø Nocciolo		
d ₁	TPI	mm	Ø mini	Ø maxi	Ø guide line
10	36	0.706	4.064	4.216	4.10
10	40	0.635	4.141	4.292	4.20
10	56	0.454	4.344	4.445	4.40
1/4"	36	0.706	5.588	5.740	5.65
1/4"	40	0.635	5.665	5.816	5.70
1/4"	48	0.529	5.766	5.892	5.80
1/4"	56	0.454	5.868	5.969	5.90
5/16"	36	0.706	7.163	7.340	7.25
3/8"	36	0.706	8.763	8.940	8.80
7/16"	24	1.058	9.957	10.210	10.00
1/2"	24	1.058	11.557	11.811	11.60
1"	14	1.814	23.445	23.825	23.60

PERÇAGE D'AVANT-TROUS — PREFORI PER FILETTARE

G (BSP) DIN EN ISO 228

Ø"	P	P	Ø Noyau - Ø Nocciolo		Ø guide line
			Ø mini	Ø maxi	
d ₁	TPI	mm			
1/16"	28	0.907	6.561	6.843	6.75
1/8"	28	0.907	8.566	8.848	8.75
1/4"	19	1.337	11.445	11.890	11.60
3/8"	19	1.337	14.950	15.395	15.20
1/2"	14	1.814	18.631	19.172	18.90
5/8"	14	1.814	20.587	21.128	20.90
3/4"	14	1.814	24.117	24.658	24.40
7/8"	14	1.814	27.877	28.418	28.20
1"	11	2.309	30.291	30.931	30.70
1 1/8"	11	2.309	34.939	35.579	35.30
1 1/4"	11	2.309	38.952	39.592	39.30
1 3/8"	11	2.309	41.365	42.005	41.80
1 1/2"	11	2.309	44.845	45.485	45.20
1 3/4"	11	2.309	50.788	51.428	51.20
2"	11	2.309	56.656	57.296	57.00
2 1/4"	11	2.309	62.752	63.392	63.10
2 1/2"	11	2.309	72.226	72.866	72.60
3"	11	2.309	84.926	85.566	85.30

W (BSW) BS 84, (DIN11 - 1970)

Ø"	P	P	Ø Noyau - Ø Nocciolo		Ø guide line
			Ø mini	Ø maxi	
d ₁	TPI	mm			
(3/32")	48				1.80
1/8"	40	0.635	2.362	2.591	2.50
(5/32")	32				3.10
3/16"	24	1.058	3.406	3.744	3.60
(7/32")	24				4.40
1/4"	20	1.270	4.724	5.156	4.90
5/16"	18	1.411	6.129	6.588	6.40
3/8"	16	1.588	7.493	7.988	7.70
7/16"	14	1.814	8.791	9.332	9.10
1/2"	12	2.117	9.987	10.589	10.30
5/8"	11	2.309	12.918	13.558	13.30
3/4"	10	2.540	15.799	16.484	16.20
7/8"	9	2.822	18.613	19.355	19.25
1"	8	3.175	21.336	22.149	21.90

TR ISO 2901-2904, DIN 103, 7H

Ø	P	Ø Noyau - Ø Nocciolo		Ø guide line
		Ø mini	Ø maxi	
d ₁	mm			
10	2	8	8.236	8.20
12	3	9	9.315	9.25
14	3	11	11.315	11.25
16	4	12	12.375	12.25
18	4	14	14.375	14.25
20	4	16	16.375	16.25
22	5	17	17.450	17.25
24	5	19	19.450	19.25
26	5	21	21.450	21.25
28	5	23	23.450	23.25
30	6	24	24.500	24.25
32	6	26	26.500	26.25

PG DIN 40430

Ø	P	P	Ø Noyau - Ø Nocciolo		Ø guide line
			Ø mini	Ø maxi	
d ₁	TPI	mm			
7	20	1.270	11.28	11.43	11.35
9	18	1.411	13.86	14.01	13.90
11	18	1.411	17.26	17.41	17.30
13.5	18	1.411	19.06	19.21	19.10
16	18	1.411	21.16	21.31	21.20
21	16	1.588	26.78	27.03	26.80
29	16	1.588	35.48	35.73	35.50
36	16	1.588	45.48	45.73	45.50
42	16	1.588	52.48	52.73	52.50
48	16	1.588	57.78	58.03	57.80

S NIHS 06-10, 3G5H (tol. standard - toll. standard)

Ø	P	Ø Noyau - Ø Nocciolo		Ø guide line
		Ø mini	Ø maxi	
d ₁	mm			
0.3	0.080	0.223	0.240	0.23
0.35	0.090	0.264	0.286	0.28
0.4	0.100	0.304	0.330	0.32
0.5	0.125	0.380	0.415	0.41
0.6	0.150	0.456	0.502	0.50
0.7	0.175	0.532	0.585	0.58
0.8	0.200	0.608	0.665	0.66
0.9	0.225	0.684	0.745	0.74
1	0.250	0.760	0.825	0.82
1.2	0.250	0.960	1.025	1.02
1.4	0.300	1.112	1.185	1.18

SF NIHS 06-10, 3G5H (tol. standard - toll. standard)

Ø	P	Ø Noyau - Ø Nocciolo		Ø guide line
		Ø mini	Ø maxi	
d ₁	mm			
1.4	0.200	1.208	1.265	1.26
1.6	0.200	1.408	1.465	1.46
1.8	0.200	1.608	1.665	1.66
2	0.200	1.808	1.865	1.86
2.2	0.200	2.008	2.065	2.06
2.2	0.250	1.960	2.025	2.02
2.5	0.200	2.308	2.365	2.36
2.5	0.250	2.260	2.325	2.32

SL Safelock SL 15-01

Ø	P	Ø Noyau - Ø Nocciolo		Ø guide line
		Ø mini	Ø maxi	
d ₁	mm			
0.3	0.060	0.264	0.278	0.27
0.35	0.060	0.314	0.328	0.32
0.4	0.080	0.356	0.372	0.36
0.5	0.100	0.448	0.466	0.46
0.6	0.125	0.538	0.559	0.55
0.7	0.150	0.628	0.651	0.64
0.8	0.150	0.728	0.751	0.74
0.9	0.175	0.818	0.844	0.83
1	0.200	0.908	0.936	0.92
1.2	0.200	1.108	1.136	1.12
1.4	0.250	1.288	1.321	1.30

DIAMÈTRE DE TOURNAGE — DIAMETRI DI TORNITURA

M DIN 13, ISO 261, *6h / 6g

Ø	P	Ø Ext. vis - Ø Est. vite		Ø guide line
		Ø mini	Ø maxi	
d ₁	mm			
*1	0.25	0.933	1.000	0.97
*1.1	0.25	1.033	1.100	1.07
*1.2	0.25	1.133	1.200	1.17
*1.4	0.30	1.325	1.400	1.36
1.6	0.35	1.496	1.581	1.54
1.7	0.35	1.596	1.681	1.64
1.8	0.35	1.696	1.781	1.74
2	0.40	1.886	1.981	1.93
2.2	0.45	2.080	2.180	2.13
2.3	0.40	2.186	2.300	2.23
2.5	0.45	2.380	2.480	2.43
2.6	0.45	2.480	2.600	2.53
3	0.50	2.874	2.980	2.92
3.5	0.60	3.354	3.479	3.41
4	0.70	3.838	3.978	3.91
4.5	0.75	4.338	4.478	4.40
5	0.80	4.826	4.976	4.90
6	1.00	5.794	5.974	5.88
7	1.00	6.794	6.974	6.88
8	1.25	7.760	7.972	7.87
9	1.25	8.760	8.972	8.87
10	1.50	9.732	9.968	9.85
11	1.50	10.732	10.968	10.85
12	1.75	11.701	11.966	11.83
14	2.00	13.682	13.962	13.82
16	2.00	15.682	15.962	15.82
18	2.50	17.623	17.958	17.79
20	2.50	19.623	19.958	19.79
22	2.50	21.623	21.958	21.79
24	3.00	23.577	23.952	23.76
27	3.00	26.577	26.952	26.76
30	3.50	29.522	29.947	29.73
33	3.50	32.522	32.947	32.73
36	4.00	35.465	35.940	35.70
39	4.00	38.465	38.940	38.70
42	4.50	41.437	41.937	41.69
45	4.50	44.437	44.937	44.69
48	5.00	47.399	47.929	47.66
52	5.00	51.399	51.929	51.66
56	5.50	55.365	55.925	55.65

MF DIN 13, ISO 261, 6g

Ø	P	Ø Ext. vis - Ø Est. vite		Ø guide line
		Ø mini	Ø maxi	
d ₁	mm			
8	1.00	7.794	7.974	7.88
9	0.75	8.838	8.978	8.90
9	1.00	8.794	8.974	8.88
10	0.75	9.838	9.978	9.90
10	1.00	9.794	9.974	9.88
10	1.25	9.760	9.972	9.86
11	0.75	10.838	10.978	10.90
11	1.00	10.794	10.974	10.88
12	1.00	11.794	11.974	11.88
12	1.25	11.760	11.972	11.86
12	1.50	11.732	11.968	11.85
14	1.00	13.794	13.974	13.88
14	1.25	13.760	13.972	13.86
14	1.50	13.732	13.968	13.85
15	1.00	14.794	14.974	14.88
15	1.50	14.732	14.968	14.85
16	1.00	15.794	15.974	15.88
16	1.50	15.732	15.968	15.85
17	1.00	16.794	16.974	16.88
17	1.50	16.732	16.968	16.85
18	1.00	17.794	17.974	17.88
18	1.50	17.732	17.968	17.85
18	2.00	17.682	17.962	17.82
20	1.00	19.794	19.974	19.88
20	1.50	19.732	19.968	19.85
20	2.00	19.682	19.962	19.82
22	1.00	21.794	21.974	21.88
22	1.50	21.732	21.968	21.85
22	2.00	21.682	21.962	21.82
24	1.00	23.794	23.974	23.88
24	1.50	23.732	23.968	23.85
24	2.00	23.682	23.962	23.82
25	1.00	24.794	24.974	24.88
25	1.50	24.732	24.968	24.85
25	2.00	24.682	24.962	24.82
27	1.00	26.794	26.974	26.88
27	1.50	26.732	26.968	26.85
27	2.00	26.682	26.962	26.82
28	1.00	27.794	27.974	27.88
28	1.50	27.732	27.968	27.85
28	2.00	27.682	27.962	27.82
30	1.00	29.794	29.974	29.88
30	1.50	29.732	29.968	29.85
30	2.00	29.682	29.962	29.82
30	3.00	29.577	29.952	29.76
32	1.50	31.732	31.968	31.85
32	2.00	31.682	31.962	31.82
33	1.50	32.732	32.968	32.85
33	2.00	32.682	32.962	32.82
33	3.00	32.577	32.952	32.76
35	1.50	34.732	34.968	34.85
36	1.50	35.732	35.968	35.85
36	2.00	35.682	35.962	35.82
36	3.00	35.577	35.952	35.76
39	1.50	38.732	38.968	38.85
39	2.00	38.682	38.962	38.82
39	3.00	38.577	38.952	38.76

MF DIN 13, ISO 261, 6g

Ø	P	Ø Ext. vis - Ø Est. vite		Ø guide line
		Ø mini	Ø maxi	
d ₁	mm			
2.5	0.35	2.396	2.481	2.44
3	0.35	2.896	2.981	2.94
3.5	0.35	3.396	3.481	3.44
4	0.50	3.874	3.980	3.93
4.5	0.50	4.374	4.480	4.43
5	0.50	4.874	4.980	4.93
5.5	0.50	5.374	5.480	5.43
6	0.75	5.838	5.978	5.90
7	0.75	6.838	6.978	6.90
8	0.75	7.838	7.978	7.90

DIAMÈTRE DE TOURNAGE — DIAMETRI DI TORNITURA

MF DIN 13, ISO 261, 6g

Ø	P	Ø Ext. vis - Ø Est. vite		
		Ø mini	Ø maxi	
d ₁	mm			Ø guide line
40	1.50	39.732	39.968	39.85
40	2.00	39.682	39.962	39.82
40	3.00	39.577	39.952	39.76
42	1.50	41.732	41.968	41.85
42	2.00	41.682	41.962	41.82
42	3.00	41.577	41.952	41.76
45	1.50	44.732	44.968	44.85
45	2.00	44.682	44.962	44.82
45	3.00	44.577	44.952	44.76
48	1.50	47.732	47.968	47.85
48	2.00	47.682	47.962	47.82
48	3.00	47.577	47.952	47.76
50	1.50	49.732	49.968	49.85
50	2.00	49.682	49.962	49.82
50	3.00	49.577	49.952	49.76
52	1.50	51.732	51.968	51.85
52	2.00	51.682	51.962	51.82
52	3.00	51.577	51.952	51.76
52	4.00	51.465	51.940	51.70

UNF ASME B1.1, 2A

Ø"	P	P	Ø Ext. vis - Ø Est. vite		
			Ø mini	Ø maxi	
d ₁	TPI	mm			Ø guide line
0	80	0.318	1.431	1.511	1.47
1	72	0.353	1.751	1.838	1.79
2	64	0.397	2.073	2.169	2.12
3	56	0.454	2.393	2.496	2.44
4	48	0.529	2.713	2.827	2.77
5	44	0.577	3.036	3.157	3.10
6	40	0.635	3.356	3.484	3.42
8	36	0.706	4.006	4.145	4.08
10	32	0.794	4.651	4.803	4.73
12	28	0.907	5.296	5.461	5.38
1/4"	28	0.907	6.160	6.324	6.24
5/16"	24	1.058	7.727	7.909	7.82
3/8"	24	1.058	9.315	9.497	9.41
7/16"	20	1.270	10.874	11.079	10.98
1/2"	20	1.270	12.462	12.666	12.56
9/16"	18	1.411	14.031	14.251	14.14
5/8"	18	1.411	15.619	15.839	15.73
3/4"	16	1.588	18.774	19.011	18.89
7/8"	14	1.814	21.923	22.184	22.05
1"	12	2.117	25.065	25.354	25.21
1 1/8"	12	2.117	28.240	28.529	28.38
1 1/4"	12	2.117	31.415	31.704	31.56
1 3/8"	12	2.117	34.588	34.876	34.73
1 1/2"	12	2.117	37.763	38.051	37.91

UNC ASME B1.1, 2A

Ø"	P	P	Ø Ext. vis - Ø Est. vite		
			Ø mini	Ø maxi	
d ₁	TPI	mm			Ø guide line
1	64	0.397	1.743	1.838	1.79
2	56	0.454	2.066	2.169	2.12
3	48	0.529	2.383	2.496	2.44
4	40	0.635	2.695	2.824	2.76
5	40	0.635	3.026	3.154	3.09
6	32	0.794	3.333	3.484	3.41
8	32	0.794	3.991	4.142	4.07
10	24	1.058	4.618	4.800	4.71
12	24	1.058	5.279	5.461	5.37
1/4"	20	1.270	6.117	6.322	6.22
5/16"	18	1.411	7.687	7.907	7.80
3/8"	16	1.588	9.254	9.491	9.37
7/16"	14	1.814	10.816	11.076	10.95
1/2"	13	1.954	12.386	12.661	12.52
9/16"	12	2.117	13.958	14.246	14.10
5/8"	11	2.309	15.528	15.834	15.68
3/4"	10	2.540	18.677	19.004	18.84
7/8"	9	2.822	21.824	22.176	22.00
1"	8	3.175	24.969	25.349	25.16
1 1/8"	7	3.629	28.103	28.519	28.31
1 1/4"	7	3.629	31.278	31.694	31.49
1 3/8"	6	4.233	34.402	34.864	34.63
1 1/2"	6	4.233	37.577	38.039	37.81
1 3/4"	5	5.080	43.860	44.381	44.12
2"	4.5	5.644	50.168	50.726	50.45
2 1/4"	4.5	5.644	56.518	57.076	56.80
2 1/2"	4	6.350	62.817	63.421	63.12
2 3/4"	4	6.350	69.165	69.768	69.47
3"	4	6.350	75.515	76.118	75.82
3 1/4"	4	6.350	81.862	82.466	82.16
3 1/2"	4	6.350	88.212	88.816	88.51
3 3/4"	4	6.350	94.560	95.163	94.86
4"	4	6.350	100.910	101.513	101.21

UNEF ASME B1.1, 2A

Ø"	P	P	Ø Ext. vis - Ø Est. vite		
			Ø mini	Ø maxi	
d ₁	TPI	mm			Ø guide line
12	32	0.794	5.312	5.463	5.39
1/4"	32	0.794	6.173	6.324	6.25
5/16"	32	0.794	7.760	7.912	7.84
3/8"	32	0.794	9.348	9.499	9.42
7/16"	28	0.907	10.920	11.084	11.00
1/2"	28	0.907	12.507	12.672	12.59
9/16"	24	1.058	14.075	14.257	14.17
5/8"	24	1.058	15.662	15.844	15.75
11/16"	24	1.058	17.250	17.432	17.34
3/4"	20	1.270	18.812	19.016	18.91
13/16"	20	1.270	20.339	20.604	20.50
7/8"	20	1.270	21.987	22.191	22.09
15/16"	20	1.270	23.572	23.776	23.67
1"	20	1.270	25.159	25.364	25.26
1 1/8"	18	1.411	28.319	28.539	28.43
1 1/4"	18	1.411	31.491	31.711	31.60
1 1/2"	18	1.411	37.841	38.061	37.95

UN ASME B1.1, 2A

Ø"	P	P	Ø Ext. vis - Ø Est. vite		
			Ø mini	Ø maxi	
d ₁	TPI	mm			Ø guide line
5/16"	20	1.270	7.702	7.907	7.80
3/8"	20	1.270	9.289	9.494	9.39
9/16"	20	1.270	14.049	14.254	14.15
5/8"	20	1.270	15.637	15.841	15.74

DIAMÈTRE DE TOURNAGE — DIAMETRI DI TORNITURA

UN ASME B1.1, 2A

Ø"	P	P	Ø Ext. vis - Ø Est. vite		
d _i	TPI	mm	Ø mini	Ø maxi	Ø guide line
1 1/8"	8	3.175	28.141	28.521	28.33
1 1/4"	8	3.175	31.316	31.696	31.51
1 3/8"	8	3.175	34.489	34.869	34.68
1 1/2"	8	3.175	37.664	38.044	37.85
1 5/8"	8	3.175	40.839	41.219	41.03
1 3/4"	8	3.175	44.011	44.391	44.20
1 7/8"	8	3.175	47.186	47.566	47.38
2"	8	3.175	50.361	50.741	50.55
2 1/4"	8	3.175	56.709	57.089	56.90
2 1/2"	8	3.175	63.059	63.439	63.25
2 3/4"	8	3.175	69.406	69.786	69.60
3"	8	3.175	75.753	76.133	75.94

UNS ASME B1.1, 2A

Ø"	P	P	Ø Ext. vis - Ø Est. vite		
d _i	TPI	mm	Ø mini	Ø maxi	Ø guide line
10	36	0.706	4.664	4.803	4.73
10	40	0.635	4.674	4.803	4.74
10	56	0.454	4.705	4.808	4.76
1/4"	36	0.706	6.188	6.327	6.26
1/4"	40	0.635	6.198	6.327	6.26
1/4"	48	0.529	6.216	6.329	6.27
1/4"	56	0.454	6.226	6.329	6.28
5/16"	36	0.706	7.775	7.914	7.84
3/8"	36	0.706	9.360	9.499	9.43
7/16"	24	1.058	10.902	11.084	10.99
1/2"	24	1.058	12.487	12.669	12.58
1"	14	1.814	25.096	25.356	25.23

G (BSP) DIN EN ISO 228

Ø"	P	P	Ø Ext. vis - Ø Est. vite		
d _i	TPI	mm	Ø mini	Ø maxi	Ø guide line
1/16"	28	0.907	7.509	7.723	7.62
1/8"	28	0.907	9.514	9.728	9.62
1/4"	19	1.337	12.907	13.157	13.03
3/8"	19	1.337	16.412	16.662	16.54
1/2"	14	1.814	20.671	20.955	20.81
5/8"	14	1.814	22.627	22.911	22.77
3/4"	14	1.814	26.157	26.441	26.30
7/8"	14	1.814	29.917	30.201	30.06
1"	11	2.309	32.889	33.249	33.07
1 1/8"	11	2.309	37.537	37.897	37.72
1 1/4"	11	2.309	41.550	41.910	41.73
1 3/8"	11	2.309	43.963	44.323	44.14
1 1/2"	11	2.309	47.443	47.803	47.62
1 3/4"	11	2.309	53.386	53.746	53.57
2"	11	2.309	59.254	59.614	59.43
2 1/4"	11	2.309	65.276	65.710	65.49
2 1/2"	11	2.309	74.750	75.184	74.97
2 3/4"	11	2.309	81.100	81.534	81.32
3"	11	2.309	87.450	87.884	87.67
3 1/2"	11	2.309	99.896	100.330	100.11

W (BSW) BS 84

Ø"	P	P	Ø Ext. vis - Ø Est. vite		
d _i	TPI	mm	Ø mini	Ø maxi	Ø guide line
1/4"	20	1.270	6.165	6.319	6.24
5/16"	18	1.411	7.737	7.904	7.82
3/8"	16	1.588	9.312	9.489	9.40
7/16"	14	1.814	10.884	11.074	10.98
1/2"	12	2.117	12.456	12.662	12.56
5/8"	11	2.309	15.613	15.832	15.72
3/4"	10	2.540	18.771	19.004	18.89
7/8"	9	2.822	21.979	22.225	22.10
1"	8	3.175	25.138	25.400	25.27
1 1/8"	7	3.629	28.296	28.575	28.44
1 1/4"	7	3.629	31.465	31.750	31.61
1 1/2"	6	4.233	37.793	38.100	37.95
1 3/4"	5	5.080	44.117	44.450	44.28
2"	4.5	5.644	50.449	50.800	50.62
2 1/4"	4	6.350	56.779	57.150	56.96
2 1/2"	4	6.350	63.119	63.500	63.31

TR ISO 2901-2904, DIN 103, 7e

Ø	P	Ø Ext. vis - Ø Est. vite		
d _i	mm	Ø mini	Ø maxi	Ø guide line
10	2	9.820	10.000	9.91
12	3	11.764	12.000	11.88
14	3	13.764	14.000	13.88
16	4	15.700	16.000	15.85
18	4	17.700	18.000	17.85
20	4	19.700	20.000	19.85
22	5	21.665	22.000	21.83
24	5	23.665	24.000	23.83
26	5	25.665	26.000	25.83
28	5	27.665	28.000	27.83
30	6	29.625	30.000	29.81
32	6	31.625	32.000	31.81

PG DIN 40430

Ø	P	P	Ø Ext. vis - Ø Est. vite		
d _i	TPI	mm	Ø mini	Ø maxi	Ø guide line
7	20	1.270	12.3	12.5	12.40
9	18	1.411	15.0	15.2	15.10
11	18	1.411	18.4	18.6	18.50
13.5	18	1.411	20.2	20.4	20.30
16	18	1.411	22.3	22.5	22.40
21	16	1.588	28.0	28.3	28.15
29	16	1.588	36.7	37.0	36.85
36	16	1.588	46.7	47.0	46.85
42	16	1.588	53.7	54.0	53.85
48	16	1.588	59.0	59.3	59.15

Demande d'offre

Résultat test

Réclamation

Agent : _____

Contact : _____

Client : _____

E-mail : _____

Tél. ou fax : _____

Date : _____

1. Type d'outil : _____

Dimension : _____

Particularités : _____

Tolérance : _____

2. Groupe matière : _____

No de matière : _____

Dureté : _____ N/mm² / HB / HRC

Norme : _____

Allongement : _____ %

3. Filetage : borgne

débouchant

Longueur fileté : _____ mm

Avant-trou Ø : _____

Profondeur : _____ mm

Contre-perçage Ø : _____

Profondeur : _____ mm

4. Vitesse de coupe (V_c) : _____ m/min _____ l/min

Avance (f) : _____ %

5. Machine : _____

arrosage par le centre

Position de travail : horizontale

verticale

Taraudage synchrone : "Soft Rigid Tapping"

Mandrin : avec compensation axiale

pince

dérabotable

Weldon

réversible

frettage chaud / froid

avec embrayage à friction

6. Lubrifiant : émulsion

huile de coupe

air

microlubrification

Produit : _____

7. Raison du changement d'outil : usure

casse de l'outil

filetage non correct (contrôlé avec une jauge)

casse des dents d'entrée

erreur machine

casse des dents guide

8. Comparaison du rendement :

Outil à l'essai : _____

Performance et observations : _____

Remarques : _____

Richiesta d'offerta

Risultato test

Reclami

Agente: _____

Responsabile: _____

Cliente: _____

E-mail: _____

Tel. o fax: _____

Data: _____

1. Tipo d'utensile: _____

Dimensioni: _____

Particolarità: _____

Tolleranza: _____

2. Tipo di materiale: _____

Nr. materiale: _____

Durezza: _____ N/mm² / HB / HRC

Norme: _____

Allungamento: _____ %

3. Filettatura: cieco passante

Lunghezza filettatura: _____ mm

Ø Pre-foro: _____

Profondità: _____ mm

Lamatura Ø: _____

Profondità: _____ mm

4. Velocità di taglio (V_c): _____ m/min _____ l/min

Avanzamento (f): _____ %

5. Macchina: _____ lubrificazione centralizzata

Posizione di lavoro: orizzontale verticale

Maschiatura rigida: "Soft Rigid Tapping" **Maschiatore:** con compensazione assiale

rigida (pinza) sganciabile

Weldon reversibile

calettam. a caldo/ freddo con frizione

6. Lubrificante: emulsione olio da taglio aria lubrif. minima

Marca: _____

7. Motivi per il cambio dell'utensile: usura rottura del maschio
 filettatura non corretta (controllo con calibro) rottura denti d'imbocco
 errore della macchina scheggiatura denti del maschio

8. Confronto del rendimento:

Utensile in prova: _____

Performances e osservazioni: _____

Note: _____

**TOUS NOS OUTILS PEUVENT ÊTRE COMMANDÉS À
TOUT MOMENT VIA NOTRE **BOUTIQUE EN LIGNE**.
INSCRIVEZ-VOUS MAINTENANT SUR DCSWISS.COM**

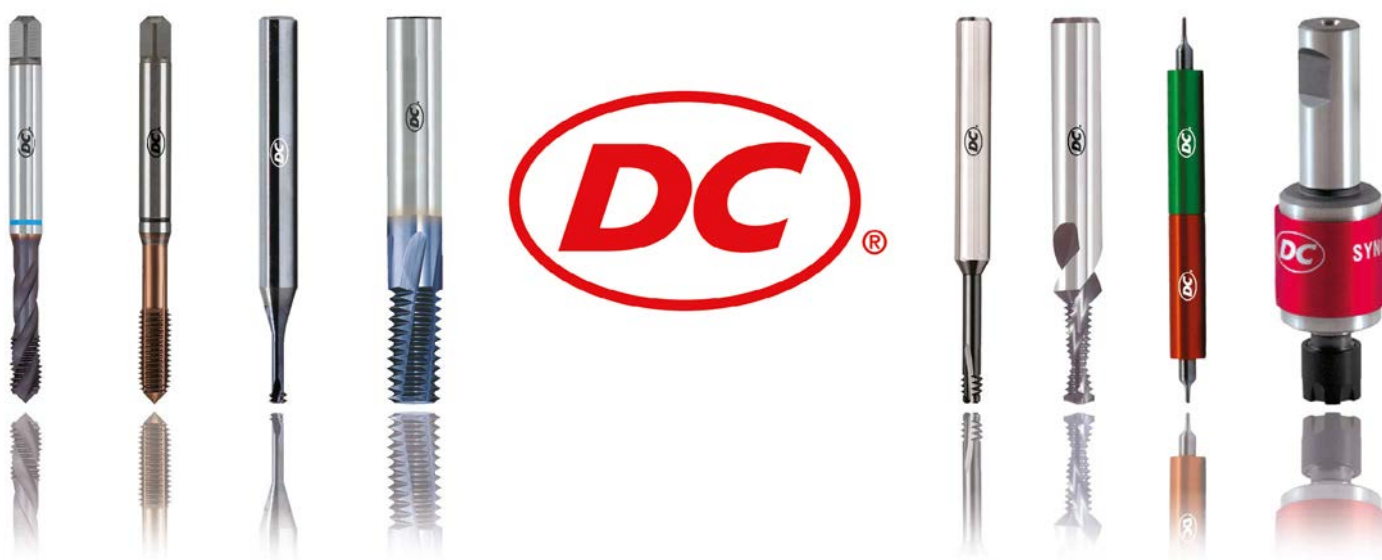

**TUTTI I NOSTRI STRUMENTI POSSONO ESSERE
ORDINATI IN QUALSIASI MOMENTO TRAMITE
IL NOSTRO **WEBSHOP**.
REGISTRATEVI ORA: DCSWISS.COM**

SUPPLÉMENTS — SUPPLEMENTI

Modifications possibles des tarauds standards blancs

Prix et délai sur demande

Modifier l'angle de coupe (dès \varnothing 5 mm)
Conditionnement des arêtes de coupe ($\varnothing \leq 52$ mm)
Rallonger l'entrée (dès \varnothing 2.5 mm)
Raccourcir l'entrée (dès \varnothing 2.5 mm)
Meuler l'entrée à hélice (dès \varnothing 5 mm)
Modifier le l3, d2, a ou d4
Rallonger les rainures ($\varnothing \geq 5$ mm - ≤ 48 mm)
Enlever pointe de centrage ($\varnothing \geq 1$ mm - ≤ 12 mm)
Alterner les filets (dès pas de 0.5 mm)
Tronquer les filets (dès \varnothing 3 mm)
Rectifier méplat Weldon ($\varnothing \geq 6$ mm - ≤ 16 mm)
Canal de lubrification, avec sortie frontale ($\varnothing \geq 3$ mm - ≤ 25.4 mm)
Canal de lubrification, avec sorties latérales ($\varnothing \geq 3$ mm - ≤ 25.4 mm)
Nitruration Plasma + traitement de surface "Vapeur"
Traitement de surface DC "V"
Revêtements : TiN, TiCN, VS, CrN, HL, etc.
Marquage supplémentaire
Raccourcir la partie mèche (N5951-SP; N5952-SP)

Bien entendu, nous fabriquons également des outils de filetage spécifiques au client selon votre dessin. Prix et délai de livraison sur demande.

Possibili modifiche dei maschi standard semilavorati

Prezzo e tempi di consegna su richiesta

Modifica dell'angolo di taglio (a partire da \varnothing 5 mm)
Condizionamento dei taglienti ($\varnothing \leq 52$ mm)
Allungamento dell'imbocco (a partire da \varnothing 2.5 mm)
Accorciamento dell'imbocco (a partire da \varnothing 2.5 mm)
Molatura dell'imbocco corretto (a partire da \varnothing 5 mm)
Modifica di l3, d2, e/o d4
Allungamento delle scanalature ($\varnothing \geq 5$ mm - ≤ 48 mm)
Rimozione del centrino frontale ($\varnothing \geq 1$ mm - ≤ 12 mm)
Filetti alternati (a partire da un passo di 0.5 mm)
Troncatura dei filetti di guida (a partire da \varnothing 3 mm)
Molatura del piano Weldon ($\varnothing \geq 6$ mm - ≤ 16 mm)
Lubrificazione interna con uscita frontale ($\varnothing \geq 3$ mm - ≤ 25.4 mm)
Lubrificazione interna con uscite radiali ($\varnothing \geq 3$ mm - ≤ 25.4 mm)
Nitrurazione al Plasma + trattamento superficiale "V"
Trattamento DC "V"
Rivestimenti: TiN, TiCN, VS, CrN, HL, ecc
Marcatura supplementare
Accorciamento della parte forante (N5951-SP; N5952-SP)

Ovviamente produciamo anche utensili di filettatura specifici per il cliente secondo il vostro disegno. Prezzo e tempi di consegna su richiesta.

CONDITIONS DE LIVRAISON

Commandes	<i>Les commandes qui ne peuvent être livrées du stock seront confirmées. Les articles qui ne sont plus fabriqués, tout en étant encore mentionnés dans le catalogue, seront considérés comme exécutions spéciales et facturés comme telles. Toute annulation de commande doit être consentie par les deux parties et formulée par écrit.</i>
Offres et confirmations de commandes	<i>Tous les descriptifs figurant dans nos offres, documents les accompagnant, indication de poids, de mesures, illustrations et dessins n'engagent le fournisseur que dans la mesure où il y fait expressément référence.</i>
Prix	<i>Nos prix s'entendent sans TVA, pour livraisons franco départ usine, emballage, port et assurance non compris. En cas d'augmentation de prix, nous nous réservons le droit de facturer les outils confirmés aux nouveaux prix.</i>
Paiement	<i>Nos factures sont payables à 30 jours net. En cas de dépassement du délai de paiement, un intérêt moratoire peut être exigé, à compter de l'échéance et calculé sur la base du taux d'escompte du moment. Les frais de remboursement, d'établissement de traite, etc., sont à la charge de l'acheteur.</i>
Réserve de propriété	<i>La marchandise reste notre entière propriété jusqu'au paiement intégral de son prix total, frais complémentaires inclus.</i>
Expéditions	<i>Les marchandises sont expédiées aux risques et périls du client.</i>
Délais de livraison	<i>Les délais de livraison sont confirmés au plus juste. Toutefois ils n'ont qu'une valeur indicative. En cas de dépassement, aucune indemnité ne peut nous être demandée et les commandes ne peuvent être annulées pour ce motif.</i>
Fabrications spéciales	<i>Pour des raisons techniques de fabrication, nous nous réservons le droit de livrer les quantités d'outils spéciaux commandées avec une tolérance de plus ou moins 15%, voire de 1 à 2 pièces pour les petites quantités.</i>
Garantie	<i>Seuls les outils reconnus défectueux par le fournisseur seront remplacés gratuitement, sans aucun autre dédommagement.</i>
Réclamations	<i>Toute réclamation doit nous parvenir au plus tard 2 semaines après réception de la marchandise.</i>
Illustrations, dessins et croquis	<i>Nos illustrations, dessins, croquis et autres documents se trouvant dans ce catalogue ne peuvent être ni copiés, ni transmis ou cédés à des tiers. Du fait de l'évolution technique et de l'éventuelle entrée en vigueur de nouvelles normes, les indications figurant dans nos catalogues peuvent subir des modifications et sont donc publiées sans engagement.</i>
Conditions spéciales	<i>En cas de force majeure, interruption partielle ou totale de notre exploitation, nous nous réservons le droit de résilier tout ou en partie nos engagements de livraison.</i>
For	<i>Les litiges sont soumis au droit suisse et le lieu de juridiction dont ils dépendent est Moutier (Suisse).</i>

CONDIZIONI GENERALI DI VENDITA

Ordini	<p>Gli ordini che non possono essere spediti da stock, saranno confermati. Gli articoli usciti di produzione ma ancora menzionati nel catalogo, saranno considerati come esecuzione speciale e pertanto fatturati come tali. Annullamenti degli ordini si accettano unicamente su accordo da convenire per iscritto.</p>
Offerte e conferme	<p>A causa del costante sviluppo dei materiali, tutte le descrizioni che figurano nelle nostre offerte, documenti che l'accompagnano, indicazione di peso, misure, illustrazioni e disegni sono indicativi. I dati hanno valore obbligatorio soltanto se quest'ultimi sono specificati espressamente.</p>
Prezzi	<p>I nostri prezzi s'intendono senza TVA, per merce resa franco fabbrica, materiale imballato, porto e assicurazione escluse. In caso di un aumento dei prezzi, ci riserviamo il diritto di fatturare gli utensili confermati ai nuovi prezzi.</p>
Pagamenti	<p>Entro 30 giorni dalla data della fattura, netto. In caso di mancato o ritardato pagamento alla scadenza, potrà essere richiesto un interesse di mora a partire dalla scadenza della fattura e calcolato sulla base del tasso di sconto in vigore al momento. Spese di rimborso, di emissione tratta, ecc., sono a carico dell'acquirente.</p>
Diritti di proprietà	<p>Il materiale resta di nostra proprietà sino al completo pagamento del prezzo totale, spese supplementari incluse.</p>
Spedizione	<p>La spedizione avviene a rischio dell'acquirente.</p>
Termine di consegna	<p>I termini di consegna, pur se indicati con la massima cura, non sono impegnativi. Non si accettano responsabilità relative a richieste di indennità dovute per perdite causate direttamente o conseguentemente a ritardi di consegna.</p>
Consegna utensili speciali	<p>Ci riserviamo il diritto di fornire fino al 15 % in più o in meno della quantità degli utensili speciali ordinati, uno o due pezzi per le piccole quantità.</p>
Garanzia	<p>Solo gli utensili riconosciuti difettosi dal fornitore saranno sostituiti gratuitamente senza ulteriori compensi.</p>
Reclami	<p>Reclami saranno presi in considerazione entro 15 giorni dal ricevimento della merce.</p>
Illustrazioni, disegni e schemi	<p>E' severamente proibito riprodurre o cedere a terzi disegni o altre documentazioni contenute in questo catalogo. A causa dell'evoluzione tecnica e dell'eventuale introduzione di nuove norme, le indicazioni che figurano nel nostro catalogo, possono subire modifiche senza preavviso e sono pertanto da considerarsi non impegnative.</p>
Condizioni speciali	<p>In caso di forza maggiore, interruzione parziale o totale della nostra produzione, ci riserviamo il diritto di annullare, parzialmente o completamente i nostri impegni di consegna.</p>
Foro competente	<p>Le contestazioni sono soggette alla legge svizzera. Il foro competente è Moutier (Svizzera).</p>

DC PROGRAMME OVERVIEW



THREAD CUTTING

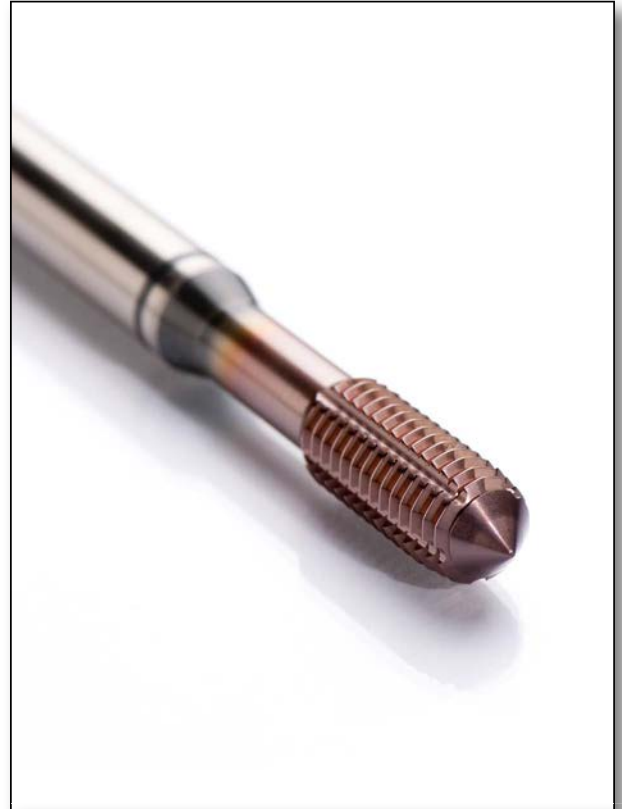

THREAD FORMING



RIGID TAPPING



TAPPING CHUCKS



THREAD WHIRLING



THREAD MILLING



THREAD DIES



THREAD GAUGES



Schweizerische Eidgenossenschaft
Confédération suisse
Confederazione Svizzera
Confederaziun svizra

Federal Department of Economic Affairs,
Education and Research EAER
State Secretariat for Economic Affairs SECO
Swiss Accreditation Service SAS

Swiss Confederation

Based on the Accreditation and Designation Ordinance dated 17 June 1996 and on the advice of the Federal Accreditation Commission, the Swiss Accreditation Service (SAS) grants to

DC NANO TOOLS SA
Métrologie
Grand-rue 19
2735 Malleray



Period of accreditation:
06.01.2021 until 05.01.2026
(1st accreditation: 06.01.2016)

the accreditation as

Calibration laboratory for Length

International standard: ISO/IEC 17025:2017
Swiss standard: SN EN ISO/IEC 17025:2018

3003 Berne, 17.11.2020
Swiss Accreditation Service SAS

Head of SAS
Konrad Flück

SAS is a signatory of the multilateral agreements of the European co-operation for Accreditation (EA) for the fields of testing, calibration, inspection and certification of management systems, certification of personnel and certification of products, processes and services, of the International Accreditation Forum (IAF) for the fields of certification of management systems and certification of products, processes and services and of the International Laboratory Accreditation Cooperation (ILAC) for the fields of testing and calibration.

Certificate of the Swiss Private Sector Energy Agency

Voluntary Climate Protection and Energy Efficiency

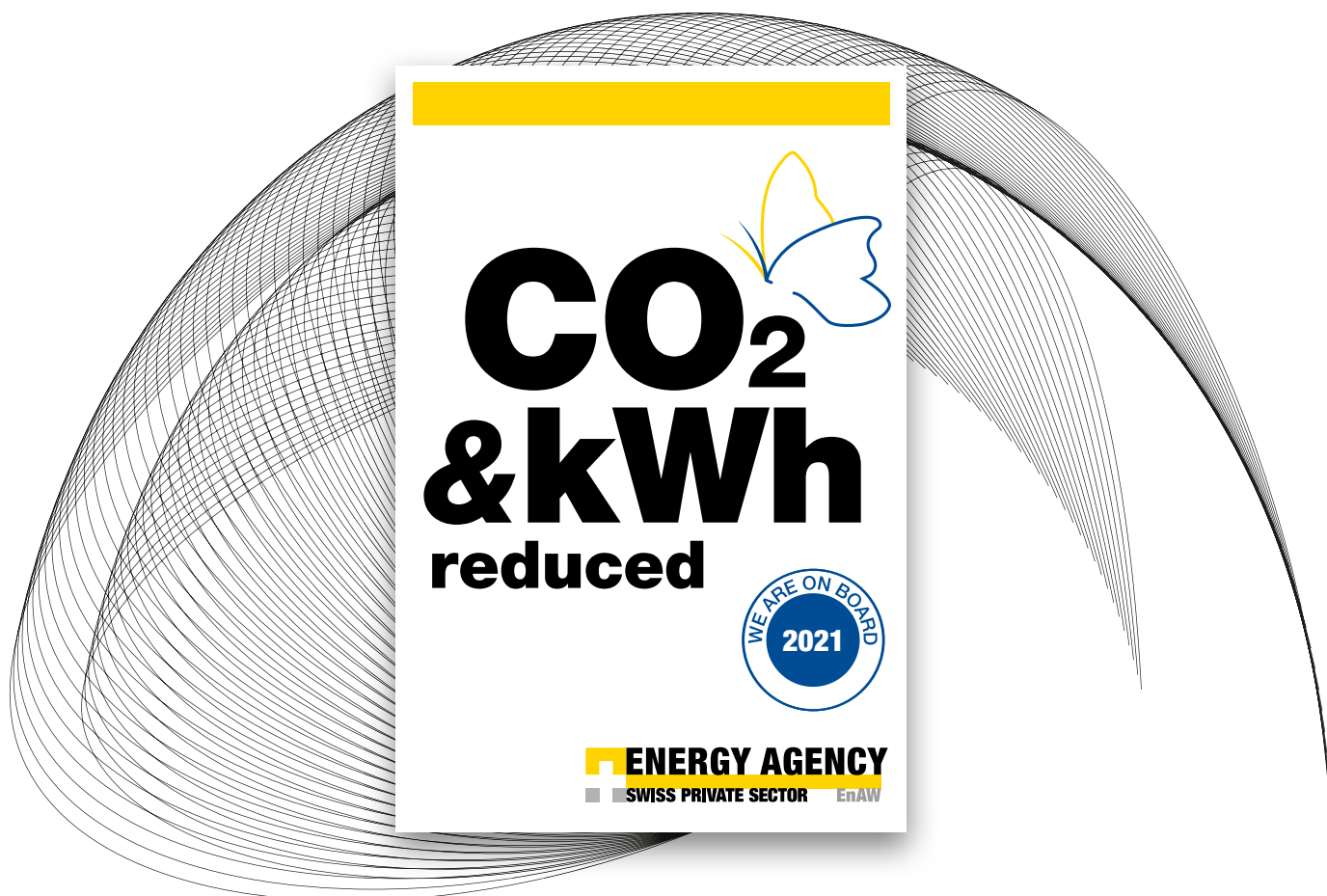

DC Swiss SA

DC Swiss SA is convinced of the need to stand up for sustainable climate protection. By voluntarily declaring its adherence to the Swiss Private Sector Energy Agency programme, DC Swiss SA commits to actively reducing CO₂ emissions and optimizing energy efficiency. The Swiss Federal Government, cantons and private sector partners honor the target agreement.

Dr. Jacqueline Jakob
Swiss Private Sector Energy Agency

1st January 2021

Martin Kernen
Swiss Private Sector Energy Agency

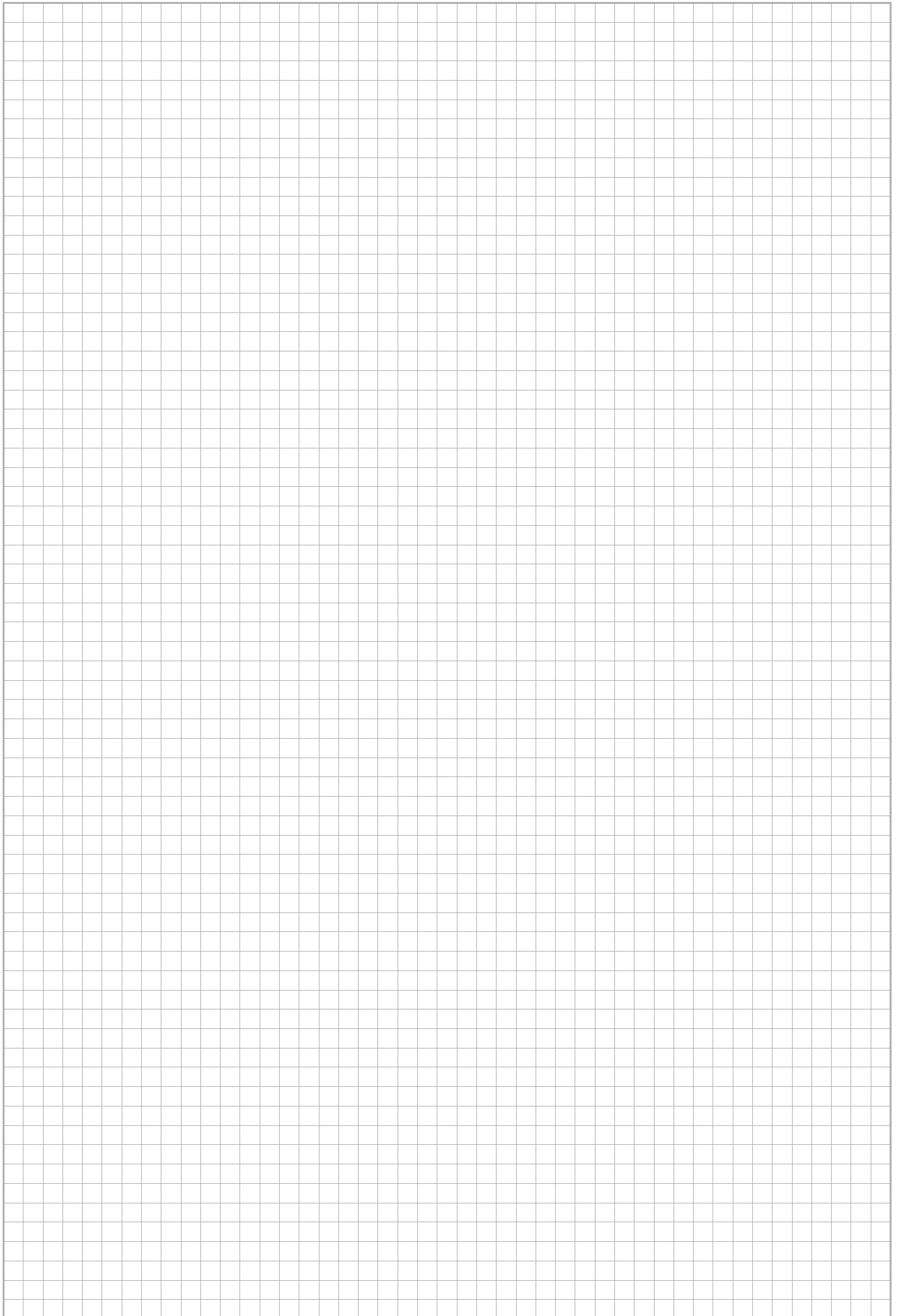

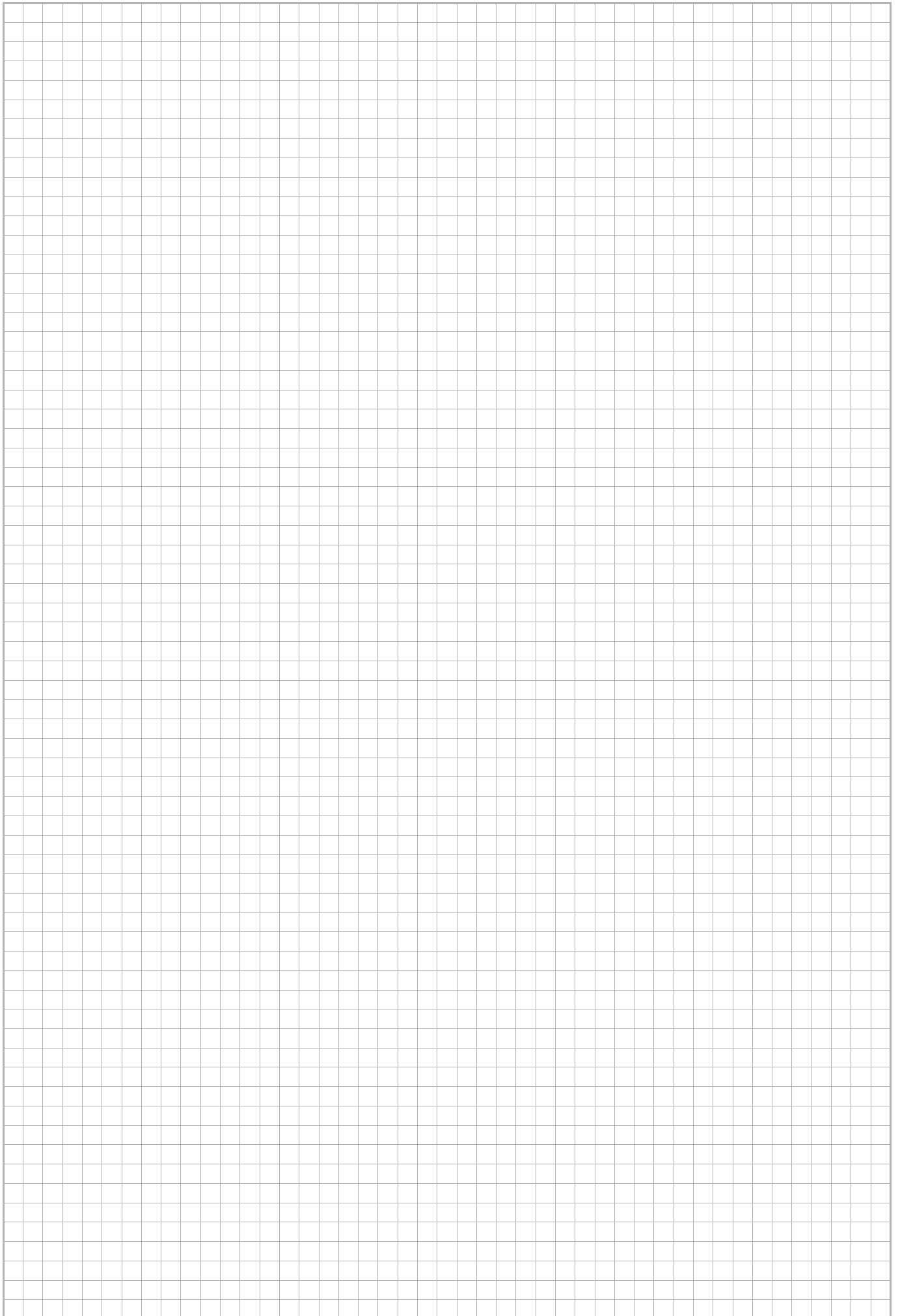

SRT 520 DC SYNCHRO

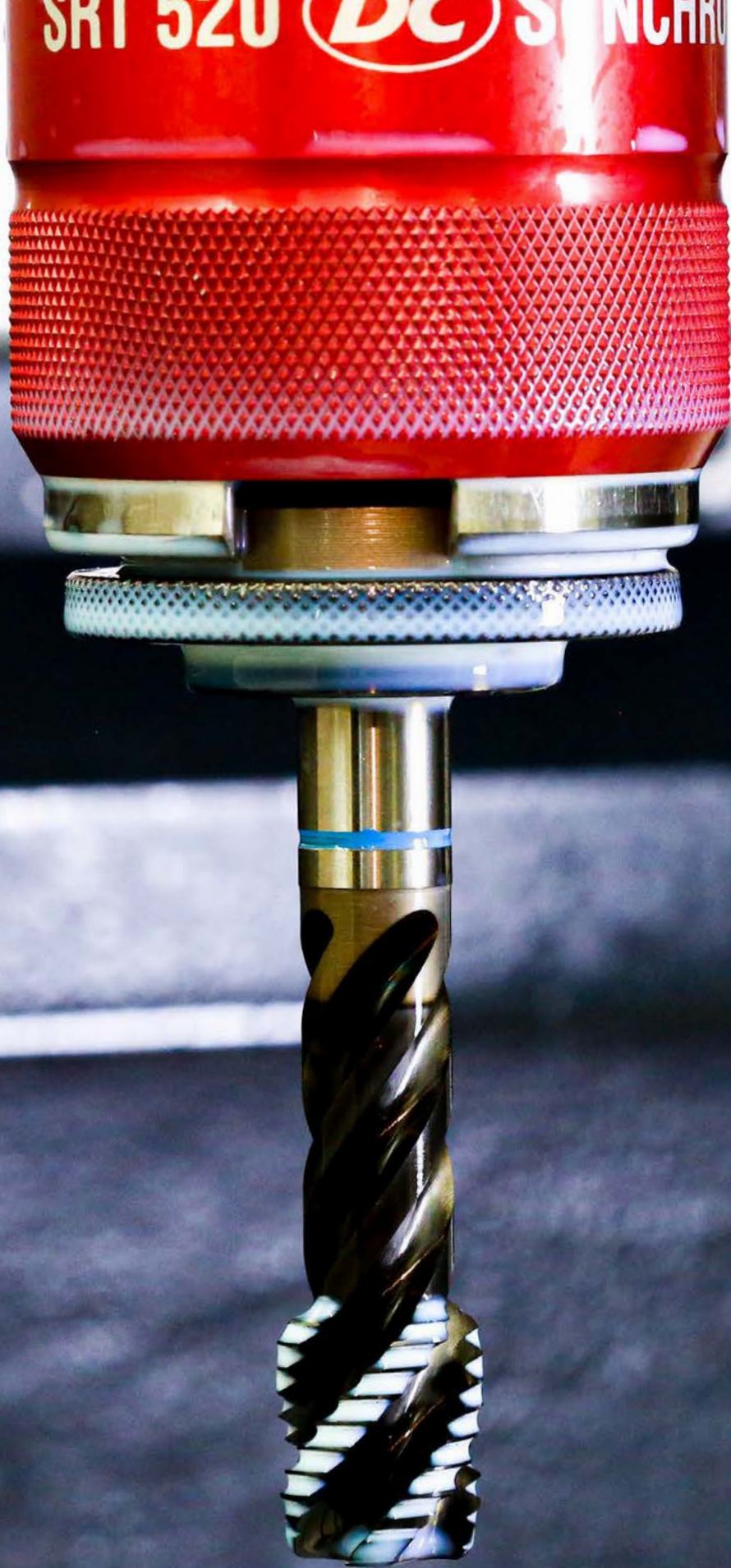



DC SWISS SA
Grand-Rue 19
CH-2735 Malleray
Tel. + 41 32 491 63 63
info@dcswiss.ch



DC Nano Tools SA
Grand-Rue 19
CH-2735 Malleray
Tel. + 41 32 491 63 63
info@dcswiss.ch

DC Swiss GmbH
Graseggerstrasse 125
DE-50737 Köln
Tel. + 49 221 995 532 0
info@dcswiss.de

DC Swiss s.r.l
Via Canova 10
IT-20017 Rho
Tel. + 39 02 669 40 41
info@dcswiss.it

DC Swiss UK Ltd
9 Orgreave Road
GB-Sheffield S13 9LQ
Tel. + 44 114 293 90 13
info@dcswiss.co.uk

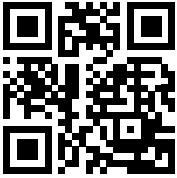

dcswiss.com



AVERTISSEMENT

Une défaillance technique ou la négligence peuvent être à l'origine de la casse partielle ou totale d'un outil de filetage et atteindre à la santé de l'opérateur. Il est impératif de suivre scrupuleusement les dispositions de sécurité et de santé des entreprises actives dans le traitement du métal. Le port de lunettes de protection est indispensable.

Le ré-affûtage des outils de filetage provoque de la poussière dangereuse pour la santé et ne peut être exécuté que selon des instructions de sécurité précises.

AVVERTENZA

Un guasto tecnico o la negligenza possono essere all'origine della rottura parziale o totale di un utensile per filettare e causare un danno alla salute dell'operatore. È obbligatorio seguire scrupolosamente le disposizioni in materia di sicurezza e a salvaguardia della salute che le società prescrivono nel campo della lavorazione dei metalli. È obbligatorio adottare gli occhiali di protezione.

La riaffilatura dei maschi crea della polvere pericolosa per la salute e può essere eseguita solo seguendo precise istruzioni di sicurezza.

D'éventuels changements ou modifications concernant des données techniques ou des erreurs d'impression ne donnent droit à aucun dédommagement.

Toutes reproductions ou extraits de textes, d'illustrations, de dessins ou de croquis figurant dans ce catalogue sont strictement interdits.

Eventuali modifiche di contenuto tecnico, come modifiche d'altro tipo, errori di stampa, non consentono alcun diritto a richieste d'indennizzo.

Qualsiasi riproduzione di testi, fotografie, disegni o estratti è vietata.

La publication de ce nouveau catalogue annule et remplace toutes les éditions précédentes (à l'exception du catalogue TM.1) !

La pubblicazione di questo nuovo catalogo annulla e sostituisce tutte le edizioni precedenti (eccetto il catalogo TM.1)!

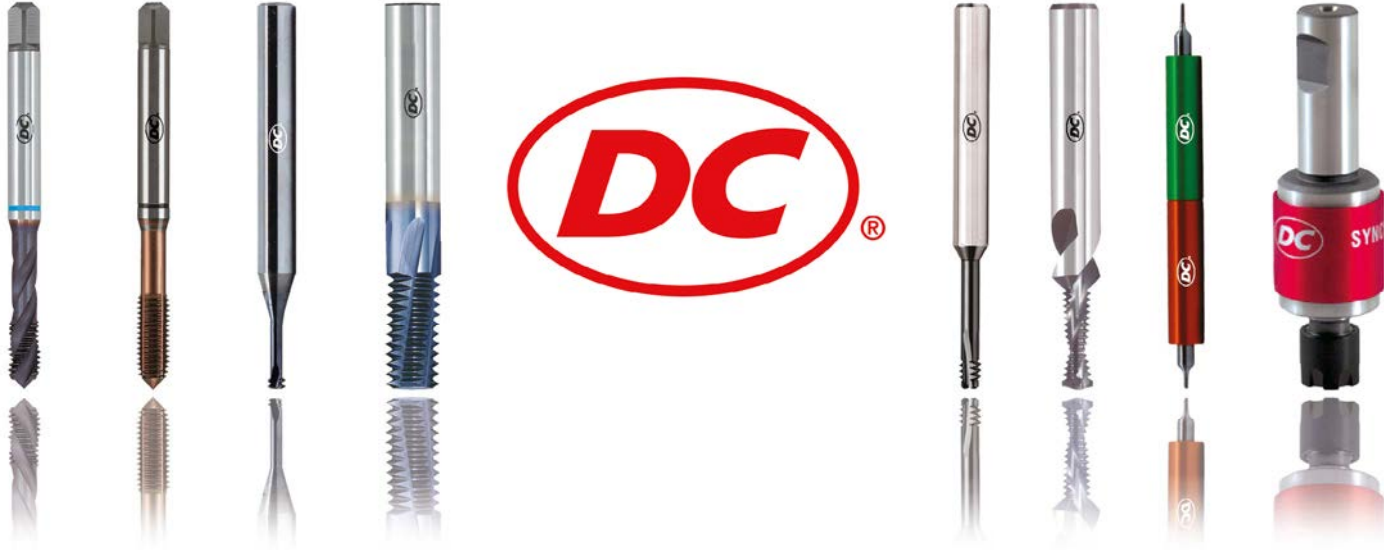

DC SWISS SA
Grand-Rue 19
CH-2735 Malleray
Tel. + 41 32 491 63 63
info@dcswiss.ch

DC Nano Tools SA
Grand-Rue 19
CH-2735 Malleray
Tel. + 41 32 491 63 63
info@dcswiss.ch

 **SWISSQUALITY**

DC Swiss GmbH
Graseggerstrasse 125
DE-50737 Köln
Tel. + 49 221 995 532 0
info@dcswiss.de

DC Swiss s.r.l
Via Canova 10
IT-20017 Rho
Tel. + 39 02 669 40 41
info@dcswiss.it

DC Swiss UK Ltd
9 Orgreave Road
GB-Sheffield S13 9LQ
Tel. + 44 114 293 90 13
info@dcswiss.co.uk