



Application and Technical Information

Carbide

Grade Descriptions.....	ATI 02-03
Insert Grade Reference.....	ATI 04-05
Feed and Speed Data	ATI 06-09
Chipform Application Range	ATI 10

Ceramic

Grade Descriptions.....	ATI 12
Insert Grade Reference.....	ATI 14-15
Feed and Speed Data	ATI 16-20
Edge Preparation and Application Guide.....	ATI 22-23

Formulas for Turning and Facing	ATI 24
--	---------------

Optional Clamps	ATI 25
------------------------------	---------------

Ceramic Productivity Manual	ATI 26-78
--	------------------

SIFOM

114-116 Boulevard Voltaire
F - 75543 Paris Cedex 11
www.sifom.fr

Tél. : +33 (0)1 48 05 87 46
Fax : +33 (0)1 48 06 07 90
email : sifom@sifom.fr

Insert Grades

Carbide

Greenleaf offers a comprehensive line of carbide inserts in grades ranging from sub-micron C-1 through C-8 classifications. An industry pioneer in coated carbide, Greenleaf offers a variety of uncoated, MT-CVD coated and PVD-coated grades. Carbide inserts are available in ANSI standard geometries with multi-purpose chipbreakers for heavy roughing through finishing.

Coated

G5125+ A tough, Co-enriched, CVD-coated grade that is ideally suited for the roughing and semi-finishing of steels in turning. Intended applications range from clean and continuous to heavily interrupted cuts in steels of various hardness and composition, at medium to high speeds and moderate feed rates.

GA5023 A high-performance grade designed for the turning and milling of various grades of cast iron, GA5023 features an advanced MT-CVD coating specifically developed to withstand the abrasiveness of cast iron in machining. Applications range from roughing to finishing in most grades of cast iron, including gray, nodular, and others. The high wear resistance and toughness of GA5023 enable high-speed machining in a wide range of feed rates.

GA5025 A high-speed MT-CVD coated grade developed primarily for turning, GA5025 excels in light roughing and finishing applications of carbon and alloy steels, including select stainless steels. GA5025 is preferred when tool life and wear resistance are essential in steel turning.

GA5026 A high-performance grade specifically developed for finish-turning in nickel- and cobalt-based super-alloys, stainless steels, hardened steels, and refractory metals. The advanced MT-CVD coating over a micro-grain substrate offers outstanding wear resistance while maintaining exceptional resistance to notching and deformation common in turning of high-strength materials. GA5026 is best applied at high speeds and low feed rates.

GA5035 A high-performance MT-CVD coated grade for turning all types of steels, GA5035 can be used for heavy roughing to finish-turning applications requiring resistance to heat deformation, thermal shock from interrupted cuts, and abrasion. GA5035 should be applied at high speeds and a moderate range of feeds. GA5035 is the primary choice for steel turning.

GA5036 A high-speed MT-CVD coated milling grade, GA5036 should be used when milling forged and cast steels along with select ductile irons. GA5036 constitutes a unique combination of toughness and heat resistance, making it suitable for heavy and light-duty milling at high cutting speeds. It is a great first choice for all steel milling.

GA5125 A high-performance MT-CVD coated carbide used primarily for the milling and turning of manganese steel. GA-5125 can also be applied in Cr-Mo steels, tool steels, and other alloyed steels in continuous and interrupted turning. GA-5125 provides excellent resistance to abrasion, crater wear, thermal shock, deformation, and built-up edge. It performs best when applied at high speeds and moderate feed rates.

G-5135 A coarse-grain MT-CVD coated carbide, G-5135 is ideal for rough steel turning operations, including scale and moderate-to-heavy interruptions, as well as select steel milling applications. G-5135 is also applicable in the roughing of cast irons and stainless steels. Apply at moderate speeds and high feed rates.

G-910 A PVD-coated grade designed for milling heat-resistant alloys, stainless steel, and low-carbon steels. G-910 should be applied at moderate speeds and moderate to high feed rates.

G-915 A multi-layer PVD-coated grade, G-915 is exceptional for milling and interrupted turning of heat-resistant alloys, stainless steels, and low-carbon steels. The coating adds heat and abrasion resistance to the tough substrate. G-915 should be used at moderate speeds and moderate to high feeds. It is a versatile grade that performs well in a variety of materials and operations outside its primary application range, making it a great choice for general machining.

G-9120 This multi-layer PVD-coated carbide grade excels at milling and turning steel castings and forgings. G-9120 was engineered specifically to maximize productivity at moderate to heavy feed rates and high depths of cut, making it ideal for heavy-turning applications in steel.

G-920 A PVD-coated grade for light-to-medium turning of heat-resistant alloys and some stainless steels. It is also an excellent grade for aluminum and refractory metals. Given its resistance to deformation and notching, G-920 should be applied at higher speeds and is well-suited for grooving and finish-turning of HRSA.

G-9230 A PVD-coated grade designed for the machining of heat-resistant alloys, titanium, and hardened and stainless steels. G-9230 works particularly well in stainless steel turning, interrupted turning of HRSA, and interrupted turning of titanium. G-9230 has superior wear resistance and toughness and is excellent for casting and forging scale conditions.

G-925 A high-performance multi-layer PVD-coated grade, G-925 is specifically designed for turning abrasive and difficult-to-machine materials. Typical applications include turning of HRSA, titanium and other refractory metals, stainless steels, and ductile cast irons. G-925 exhibits excellent resistance to notching and deformation. Apply at moderate to high speeds and moderate feeds.

G-935 A multi-layer PVD-coated grade for steel milling and turning applications requiring additional resistance to mechanical and thermal shock. The multi-layered PVD coating raises the speed envelope and wear resistance in tough milling, indexable drilling, and interrupted turning applications.

G-9610 A PVD-coated grade, G-9610 is designed for turning titanium-based alloys. The high-tech, wear-resistant, chemically stable, and very smooth and lubricious coating protects the heat-resistant, sub-micron substrate and allows for higher speeds and extended tool life in continuous cuts in non-ferrous alloys.

Uncoated

G-01 Developed for milling heat-resistant alloys, stainless steel, and low-carbon steels at low speeds and moderate to high feeds, G-01 can also be used for turning in the same range of materials with severe interruption or old machinery.

G-01M A tough sub-micron grade, G-01M is used for milling and rough turning stainless steels— even when rolling or casting skin is present. The edge strength of G-01M allows the use of sharp edges and high positive rakes in continuous or interrupted cuts.

G-10 Used for roughing all cast irons in severe conditions, including broaching. The edge strength of G-10 makes it a great choice for roughing Ni-, Co-, and Ti-based alloys with positive rakes, and any machining of non-ferrous materials when toughness is of prime importance. Apply at moderate speeds and feeds.

G-02 An excellent general-purpose cast-iron grade, G-02 can be used for milling and turning cast iron at moderately high speeds and medium feeds. G-02 is also a good choice for machining aluminum with positive rakes and light roughing of some heat-resistant alloys and stainless steels.

G-20M A sub-micron C-2 carbide grade suited for use in light-to-medium turning of titanium and heat-resistant super alloys, G-20M has the strength and edge wear characteristics to resist notching when turning high-strength materials.

G-23 G-23 is a finishing grade for all cast irons, and other short-chipping non-ferrous materials, such as brass and bronze. Apply G-23 at moderately high speeds and moderate feed rates.

G-40 Used for finish turning of cast iron and other hard-wearing materials at high speeds and light feeds in stable conditions.

G-50 Used for the heavy roughing of steel and steel castings in unstable conditions, and ferritic stainless steels in most applications, G-50 is tough enough to enable the use of positive rakes in turning.

G-53 An excellent general-purpose milling grade for steels at moderate speeds and feeds. G-53 has a good combination of toughness and wear resistance for milling, or can be used as an all-around grade for mixed-production applications.

G-60 Used for the heavy rough turning of steel, steel castings, and steel forgings. Apply G-60 at moderate speeds and heavy feed rates and depths of cut. G-60 is more wear-resistant than G-50 but is lower in toughness.

G-74 A roughing and finishing grade for steel and steel castings, G-74 should be applied at high speeds and moderate to heavy feeds. It is well-suited for the turning of steel rolls.



Insert Grade Reference

Carbide for Turning, Grooving, and Profiling

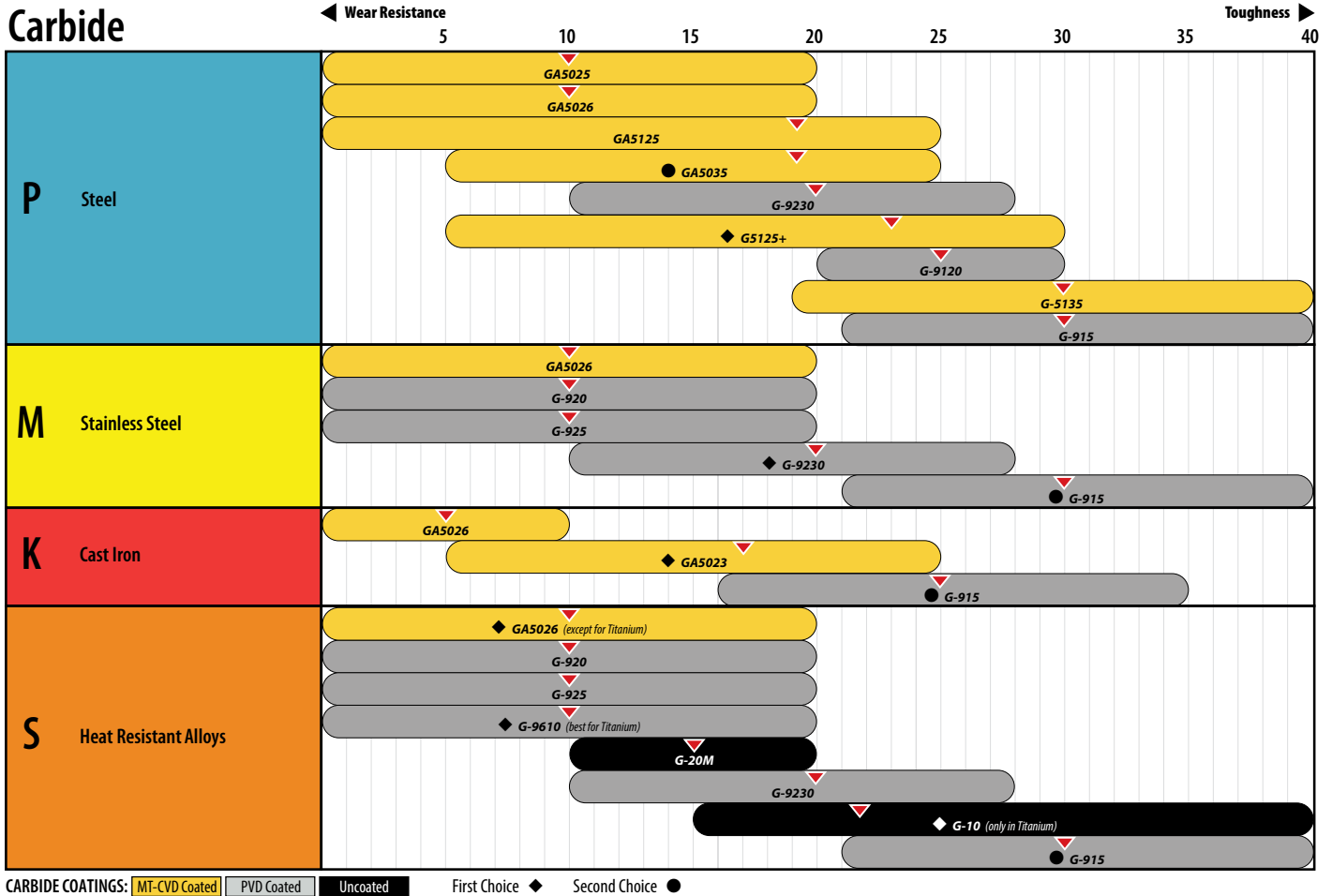

APPLICATION & TECHNICAL INFORMATION

Insert Grade Reference

Carbide for Milling

Carbide

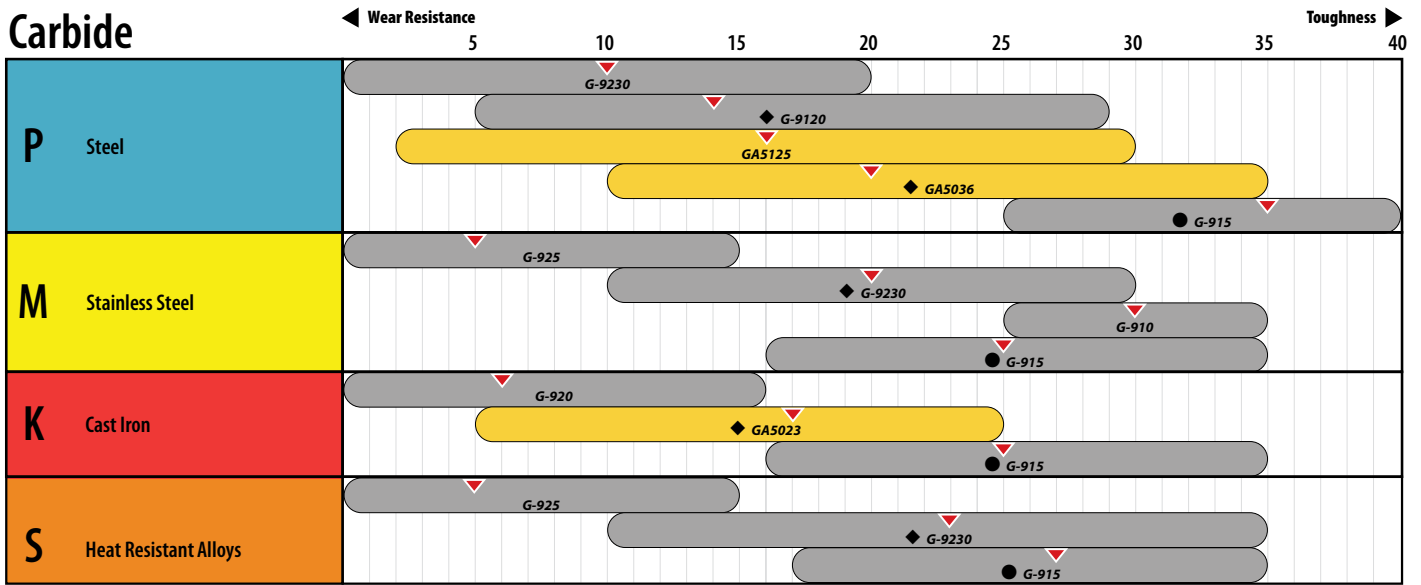

CARBIDE COATINGS: MT-CVD Coated PVD Coated Uncoated First Choice ◆ Second Choice ●

Carbide Grade Machining

Recommendations for Turning – Cutting Speed, mm/m

Steel (P)	Type	Common Alloys	HRc	MT-CVD				PVD			
				< Wear Resistance		Toughness >		< Wear Resistance		Toughness >	
				GA5026	GA5025	G5125+	GA5035	GA5125	G-9120	G-935	G-915
	Soft Steel	A36, 1018, 8620, 1045	< 25	305	275	275	245	215	230	200	185
	Alloy Steels	4340, 4140	20-25	245	220	220	200	170	185	160	150
	Tool Steels	A2, D2, S7	< 25	200	185	185	160	145	150	135	135
	Die Steels	H13, P20	< 25	200	185	185	160	145	150	135	135

Stainless Steel (M)	Type	Matrix	Common Alloys	HRc	Uncoated				MT-CVD	PVD			
					< Wear Resistance		Toughness >		GA5026	< Wear Resistance		Toughness >	
					G-20M	G-23	G-01M	G-10, G-02		G-925	G-920	G-9230	G-915
	Ferritic	Ferrite	Annealed 400 series (430, 409, 410, 439, 441, 434)	0-25	95	95	95	95	260	210	175	205	180
	Austenitic	Austenite	300 series (301, 303, 304, 304L, 309, 310, 316, 316L, 316Ti, 321), 200 series (201, 202, 204Cu, 205)	0-25	80	80	80	80	215	175	145	170	150
	Super-austenitic	Austenite	S31266, 904L, N08031, S34565, N08926, S31254, N0828, S32654, 1.4588	0-25	45	50	50	50	130	105	85	100	90
	Duplex	Ferrite + Austenite	F51 (1.4462), F53 (1.4410), F55 (1.4501), 255 (1.4507), CD3MN	0-25	55	55	55	55	150	125	100	120	105
	Martensitic	Plate martensite (high-C)	Quenched and tempered 400 series (416, 410, 420, 431)	30	90	90	90	90	235	195	160	185	165
40				80	80	80	80	215	175	145	170	150	
		Lath martensite (low-C)	Jethete M152										
	PH	Austenite and/or Lath Martensite	A286, PH14-8Mo, PH15-7Mo, 15-5PH, 15-7PH, 17-4PH, 17-7PH	35	45	45	45	45	120	100	80	95	85
0-25				50	50	50	50	135	110	90	105	95	
35				45	45	45	45	120	100	80	95	85	
40-45				40	40	40	40	110	90	70	85	75	

Cast Iron (K)	Type	Common Alloys	HRc	Uncoated	MT-CVD		PVD
				G-02	< Wear Resistance		G-915
					GA5026	GA5023	
	Lamellar (Grey) Cast Iron	GG15, GG25, GG35 (EN-GJL-150, EN-GJL-250, EN-GJL-350)	< 32	135	350	305	185
	Nodular (Ductile) Cast Iron	GGG40 - GGG80 (EN-GJS-400 -- EN-GJS-800)	< 28	110	280	245	185
	Compacted Graphite Iron (CGI)	EN-GJV-300 -- EN-GJV-500	< 28	70	185	160	130
	Austempered Ductile Iron (ADI)	800 (EN-GJS-800-10)	25-30	80	210	185	135
		1200 (EN-GS-1200-3)	35-40	60	160	135	105
		1600 (EN-GJS-HB450)	≥ 47	35	95	80	60

APPLICATION & TECHNICAL INFORMATION

Carbide Grade Machining

Recommendations for Turning – Cutting Speed, mm/m

Non-Ferrous (N)	Type	Uncoated			MT-CVD		PVD				
		< Wear Resistance		Toughness >	< Wear Resistance		Toughness >		< Wear Resistance		Toughness >
		G-20M	G-02	G-01	GA5026	GA5023	G-9610	G-920	G-9230	G-915	
	Aluminum Alloys	380	275	230	-	-	610	550	505	505	
	Brass, Copper, Bronze	120	90	75	200	150	200	185	170	170	

Heat-Resistant Super Alloys (S)	Type	Matrix	Common Alloys	HRc	Uncoated				MT-CVD	PVD					
					< Wear Resistance			Toughness >	GA5026	< Wear Resistance					Toughness >
					G-20M	G-23	G-01M	G-10, G-02		G-9610	G-925	G-920	G-9230	G-915	
	Corrosion-Resistant	Nickel or iron	Inconel 625, Incoloy 825, Hastelloy, Monel	-	35	30	30	30	85	75	70	55	65	60	
	High-Strength	Nickel or cobalt	Inconel 718, Rene 220, C-263, Haynes 188, Haynes 282, FSX-414	0-25	35	30	30	30	85	75	70	55	65	60	
35				30	25	25	25	80	65	60	50	55	50		
40-45				25	20	20	20	65	60	55	45	50	45		
45-50				25	20	20	20	60	55	50	40	45	45		
50+				20	15	15	15	50	45	40	30	35	35		
		Nickel	Waspaloy, RR1000, Rene 41-125, Udimet, GTD111-444, MM-247, C1023, IN100	0-25	30	25	25	25	80	65	60	50	55	50	
35				25	20	20	20	65	60	55	45	50	45		
40-45				25	20	20	20	50	55	50	40	45	45		
	Wear-resistant	Nickel or cobalt	Stellite, Eutalloy, Metco, Wall Colmonoy, Wearthech	20	30	25	25	25	85	75	70	55	65	60	
40				15	10	10	10	50	45	40	30	35	35		
	Titanium	Alpha Ti	Commercially pure, grades 1-4 Ti-5Al2Sn, Ti-8Al1Mo1V Ti-5522, Ti-834, Ti-6242, Ti-6246, Ti 1100	-	50	40	40	40	-	100	90	70	85	80	
-				45	35	35	35	-	90	80	65	75	70		
-				40	30	30	30	-	80	70	55	65	60		
		Alpha+Beta Ti	Ti-6Al4V, Ti-6Al6V2Sn, Ti-6Al7Nb	-	30	20	20	20	-	70	60	50	55	50	
	Beta Ti	Ti-17, Ti-5553, Ti-10V2Fe3Al, Ti-8823	-	20	15	15	15	-	60	50	40	45	45		

Hardened Steel (H)	Type	Common Alloys	HRc	MT-CVD					PVD		
				< Wear Resistance			Toughness >		< Wear Resistance		Toughness >
				GA5026	GA5025	G5125+	GA5035	GA5125	G-5135	G-9120	G-915
	Alloy Steels	4340, 4140, 2550	45-50	125	110	125	110	110	95	95	80
50-55			95	85	95	85	85	75	75	65	
	Tool Steels	D2, M4, S7, A2	45-50	95	80	95	80	80	70	70	55
50-55			75	65	75	65	65	55	55	45	
	Die Steels	H13, P20	45-50	125	110	125	110	110	95	95	80
50-55			95	85	95	85	85	75	75	65	

APPLICATION & TECHNICAL INFORMATION

Carbide Grade Machining

Recommendations for Milling – Cutting Speed, mm/m

Steel (P)	Type	Common Alloys	HRc	MT-CVD	PVD			
				GA5036	< Wear Resistance		Toughness >	
					G-9120	G-955	G-935	G-915
Soft Steel	A36, 1018, 8620, 1045	< 25	245	305	250	250	230	
Alloy Steels	4340, 4140	20-25	200	260	215	215	190	
Tool Steels	A2, D2, S7	< 25	185	215	190	190	175	
Die Steels	H13, P20	< 25	185	215	190	190	175	

Stainless Steel (M)	Type	Matrix	Common Alloys	HRc	Uncoated				MT-CVD	PVD			
					< Wear Resistance		Toughness >		GA5026	< Wear Resistance		Toughness >	
					G-20M	G-23	G-01M	G-10, G-02		G-925	G-920	G-9230	G-915
Ferritic	Ferrite	Annealed 400 series (430, 409, 410, 439, 441, 434)	0-25	125	110	110	110	305	260	205	250	210	
Austenitic	Austenite	300 series (301, 303, 304, 304L, 309, 310, 316, 316L, 316Ti, 321), 200 series (201, 202, 204Cu, 205)	0-25	105	90	90	90	255	215	170	210	175	
Super-austenitic	Austenite	S31266, 904L, N08031, S34565, N08926, S31254, N0828, S32654, 1.4588	0-25	65	55	55	55	155	130	100	125	105	
Duplex	Ferrite + Austenite	F51 (1.4462), F53 (1.4410), F55 (1.4501), 255 (1.4507), CD3MN	0-25	75	65	65	65	180	150	120	145	125	
Martensitic	Plate martensite (high-C)	Quenched and tempered 400 series (416, 410, 420, 431)	30	115	100	100	100	280	235	185	230	195	
			40	105	90	90	90	255	215	170	210	175	
	Lath martensite (low-C)	Jethete M152	35	60	50	50	50	145	120	95	115	100	
PH	Austenite and/or Lath Martensite	A286, PH14-8Mo, PH15-7Mo, 15-5PH, 15-7PH, 17-4PH, 17-7PH	0-25	65	55	55	55	160	135	105	130	110	
			35	60	50	50	50	145	120	95	115	100	
			40-45	50	45	45	45	130	110	85	105	90	

Cast Iron (K)	Type	Common Alloys	HRc	MT-CVD	PVD
				GA5023	G-915
Cast Iron (K)	Lamellar (Grey) Cast Iron	GG15, GG25, GG35 (EN-GJL-150, EN-GJL-250, EN-GJL-350)	< 32	185	380 230
	Nodular (Ductile) Cast Iron	GGG40 - GGG80 (EN-GJS-400 -- EN-GJS-800)	< 28	185	305 230
	Compacted Graphite Iron (CGI)	EN-GJV-300 -- EN-GJV-500	< 28	130	200 160
	Austempered Ductile Iron (ADI)	800 (EN-GJS-800-10) 1200 (EN-GS-1200-3) 1600 (EN-GJS-HB450)	25-30	135	230 170
			35-40	105	170 130
		≥ 47	60	105 80	

APPLICATION & TECHNICAL INFORMATION

Carbide Grade Machining







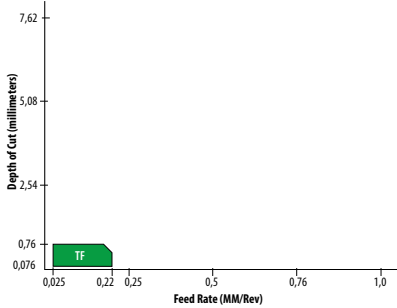

Recommendations for Milling – Cutting Speed, mm/m

Non-Ferrous (N)	Type	Uncoated G-01M	PVD	
			< Wear Resistance Toughness >	
			G-9230	G-915
Aluminum Alloys	365	610	610	
Brass, Copper, Bronze	120	200	205	

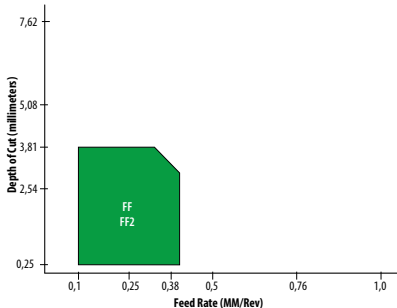
Heat-Resistant Super Alloys (S)	Type	Matrix	Common Alloys	HRc	Uncoated				MT-CVD	PVD				
					< Wear Resistance Toughness >				GA5026	< Wear Resistance Toughness >				
					G-20M	G-23	G-01M	G-10, G-02		G-9610	G-925	G-920	G-9230	G-915
Heat-Resistant Super Alloys (S)	Corrosion-Resistant	Nickel or iron	Inconel 625, Incoloy 825, Hastelloy, Monel	–	40	35	35	35	100	90	85	65	80	70
	High-Strength	Nickel or cobalt	Inconel 718, Rene 220, C-263, Haynes 188, Haynes 282, FSX-414	0-25	40	35	35	35	100	90	85	65	80	70
				35	35	30	30	30	95	80	70	60	65	60
				40-45	30	25	25	25	80	70	65	55	60	55
				45-50	30	25	25	25	70	65	60	50	55	55
				50+	25	20	20	20	60	55	50	35	40	40
	High-Strength	Nickel	Waspaloy, RR1000, Rene 41-125, Udimet, GTD111-444, MM-247, C1023, IN100	0-25	35	30	30	30	95	80	70	60	65	60
				35	30	25	25	25	80	70	65	55	60	55
				40-45	30	25	25	25	60	65	60	50	55	55
				45-50	25	20	20	20	50	55	50	35	40	40
				50+	20	10	10	10	50	50	40	35	35	35
	Wear-resistant	Nickel or cobalt	Stellite, Eutalloy, Metco, Wall Colmonoy, Wearth	20	35	30	30	30	100	90	85	65	80	70
40				20	10	10	10	60	55	50	35	40	40	
Titanium	Alpha Ti	Commercially pure, grades 1-4 Ti-5Al2Sn, Ti-8Al1Mo1V Ti-5522, Ti-834, Ti-6242, Ti-6246, Ti 1100	–	60	50	50	50	–	120	110	85	100	95	
			–	55	40	40	40	–	110	95	80	90	85	
			–	50	35	35	35	–	95	85	65	80	70	
	Alpha+Beta Ti	Ti-6Al4V, Ti-6Al6V2Sn, Ti-6Al7Nb	–	35	25	25	25	–	85	70	60	65	60	
Beta Ti	Ti-17, Ti-5553, Ti-10V2Fe3Al, Ti-8823	–	25	20	20	20	–	70	60	50	55	55		

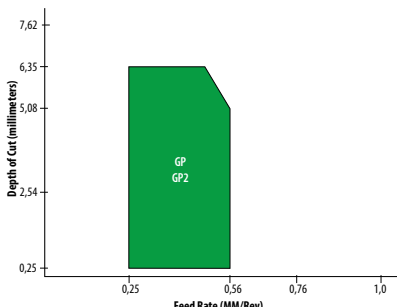
Hardened Steel (H)	Type	Common Alloys	HRc	MT-CVD		PVD		
				< Wear Resistance Toughness >		< Wear Resistance Toughness >		
				GA5026	GA5025	G5125+	GA5035	GA5125
Alloy Steels	4340, 4140, 2550	45-50	125	110	125	110	110	
			95	85	95	85	85	
Tool Steels	D2, M4, S7, A2	45-50	95	80	95	80	80	
		50-55	75	65	75	65	65	
Die Steels	H13, P20	45-50	125	110	125	110	110	
		50-55	95	85	95	85	85	

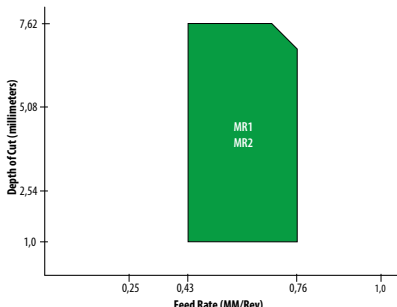
Chipform Application Range

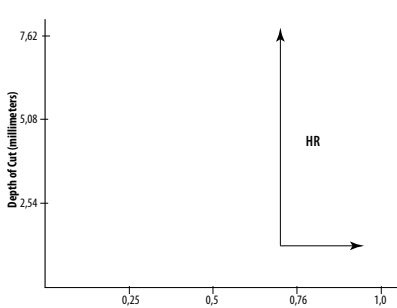
PRECISION FINISHING	<p>TF</p>  <p>Precision ground chipbreaker for nickel alloys. Good for feeds up to 0,22/rev and depths to 0,76.</p>	 <p>Graph showing application range for TF chipbreaker. Depth of Cut (mm) ranges from 0,076 to 0,76. Feed Rate (MM/Rev) ranges from 0,025 to 0,25.</p>
FINISHING	<p>FF and FF2</p>  <p>For finishing all types of material. Designed for feeds up to 0,47/rev and 3,81 depth of cut.</p>	 <p>Graph showing application range for FF and FF2 chipbreakers. Depth of Cut (mm) ranges from 0,25 to 3,81. Feed Rate (MM/Rev) ranges from 0,1 to 0,5.</p>
GENERAL PURPOSE	<p>GP and GP2</p>  <p>General purpose chipbreaker. Feed rates up to 0,56/rev and 6,35 depth of cut.</p>	 <p>Graph showing application range for GP and GP2 chipbreakers. Depth of Cut (mm) ranges from 0,25 to 6,35. Feed Rate (MM/Rev) ranges from 0,25 to 0,56.</p>
MEDIUM ROUGHING	<p>MR and MR2</p>  <p>Used for medium roughing of all material. Feeds up to 0,71/rev and depths up to 7,62.</p>	 <p>Graph showing application range for MR1 and MR2 chipbreakers. Depth of Cut (mm) ranges from 1,0 to 7,62. Feed Rate (MM/Rev) ranges from 0,25 to 0,76.</p>
HEAVY ROUGHING	<p>HR</p>  <p>Heavy roughing for all materials. Feeds above 0,58/rev. One-sided chipbreaker for heaviest feeds (MM). <i>Example: CNMM-190612 HR</i></p>	 <p>Graph showing application range for HR chipbreaker. Depth of Cut (mm) ranges from 0,254 to 7,62. Feed Rate (MM/Rev) ranges from 0,25 to 1,0.</p>

APPLICATION & TECHNICAL INFORMATION

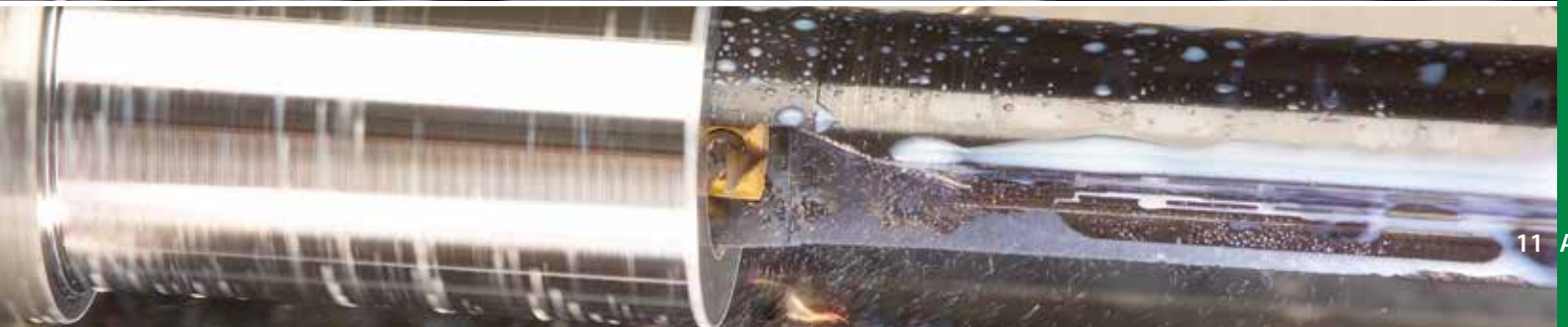
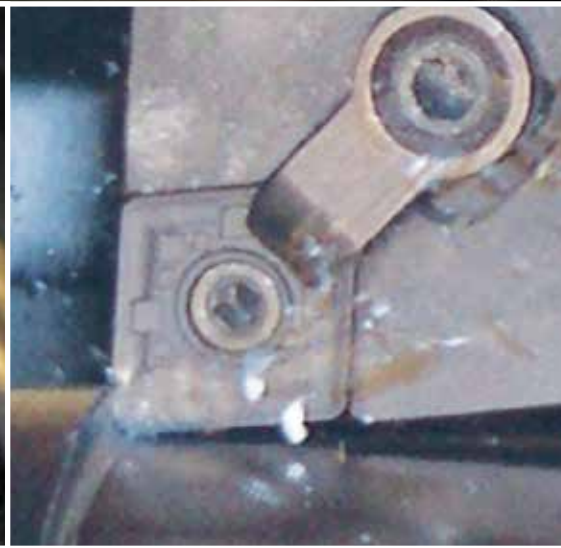

Insert Grades

Ceramic

Greenleaf is the industry leader in the development and manufacture of ceramic and coated ceramic inserts in ANSI standard and special geometries. Some of the most prominent include:

WG-300®

A SiC whisker-reinforced Al_2O_3 ceramic that is very effective at machining nickel- and cobalt-based super alloys, alloyed cast iron, and hardened steels at metal removal rates up to 10 times higher than carbide. Excellent chemical stability and wear resistance at very high cutting speeds make WG-300® the first choice worldwide for grooving and turning difficult materials.

WG-600®

A coated SiC whisker-reinforced Al_2O_3 ceramic that offers higher tool life and speed capabilities than uncoated whisker-reinforced ceramics due to the additional barrier to heat and mechanical abrasion. Application areas for WG-600® include rough and finish turning of alloys in the M, K, S, and H ISO material classes, as well as milling of hardened steels and select stainless steels. WG-600® is particularly well-suited for finish-turning and grooving of heat-resistant super alloys and is unmatched in both turning and milling of steels with a hardness above 60 HRC.

WG-700™

A SiC whisker-reinforced Al_2O_3 ceramic featuring improved toughness and a unique low-friction coating. WG-700™ is ideal for turning, grooving, and profiling nickel- and cobalt-based super alloys that other ceramics may struggle in. WG-700™ exhibits exceptional tool life and productivity in next-generation formulations or novel heat treatments of heat-resistant super alloys, and long-reach or thin-walled applications with lower rigidity.

XSYTIN®-1

A phase-toughened ceramic grade capable of sustaining extreme cutting forces. The unprecedented strength, impact toughness, and resistance to thermal shock of XSYTIN®-1 make it ideal for use in interrupted cuts, forging scale removal, and milling. In continuous cuts, the strength of XSYTIN®-1 allows the use of significantly higher feed rates or depths of cut. In machining environments with severe interruptions and scale, the edge strength of XSYTIN®-1 allows the use of very light edge preparations, minimizing the force of impact and making for a much smoother cut.

GSN100™

An engineered blend of hot-pressed silicon nitride and proprietary toughening agents that excels in the machining of cast iron. GSN100™ delivers superior wear and toughness for turning, grooving, and milling applications. It is available in all standard geometries and engineered specials.

GEM-8™

An $Al_2O_3 + TiC$ composite ceramic exhibiting excellent hardness and strength at elevated temperatures. GEM-8™ offers a high degree of predictability in roll turning and continuous cuts in ferrous alloys.



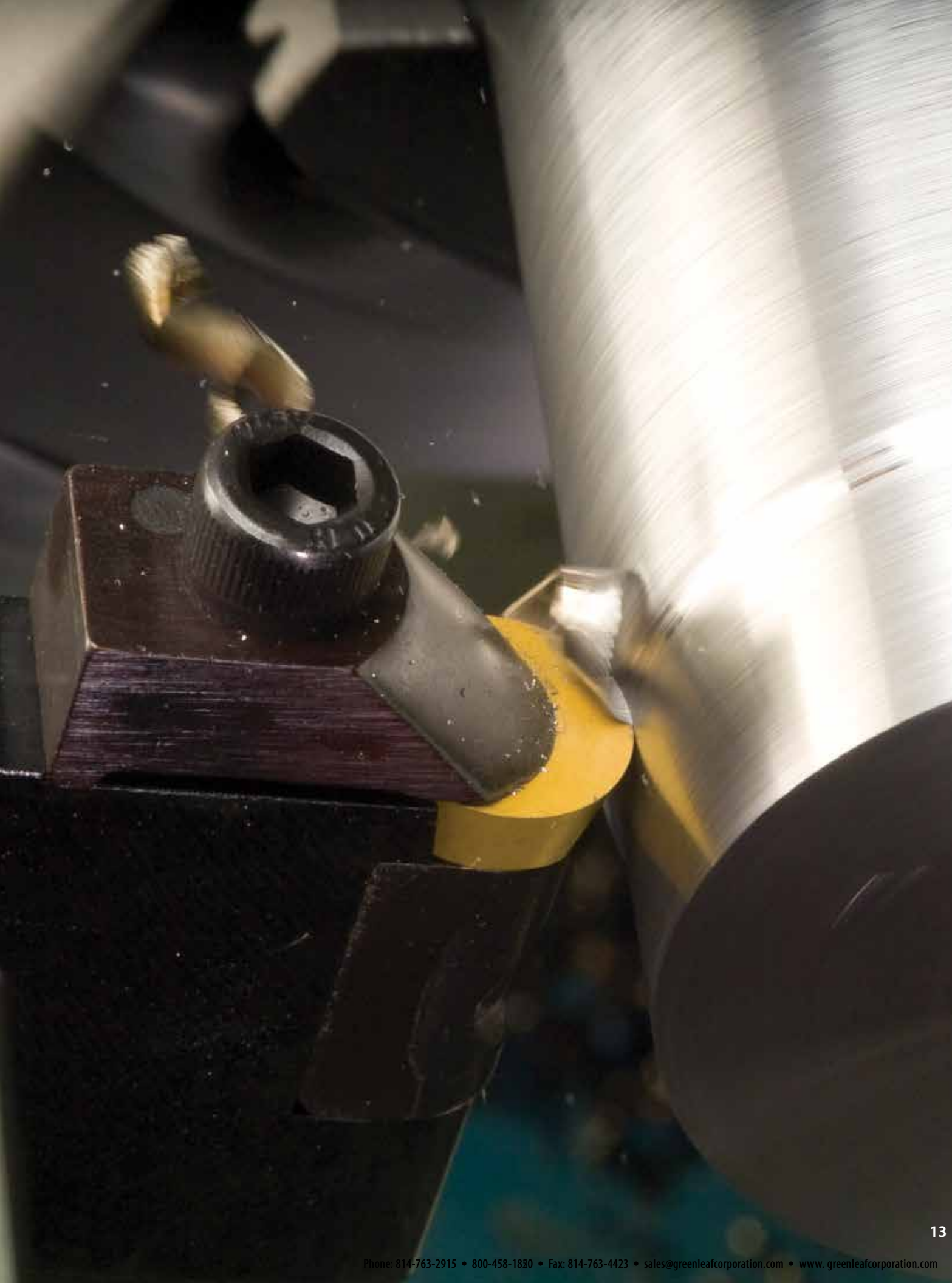

Insert Grade Reference

Ceramic for Turning, Grooving, and Profiling

Ceramics

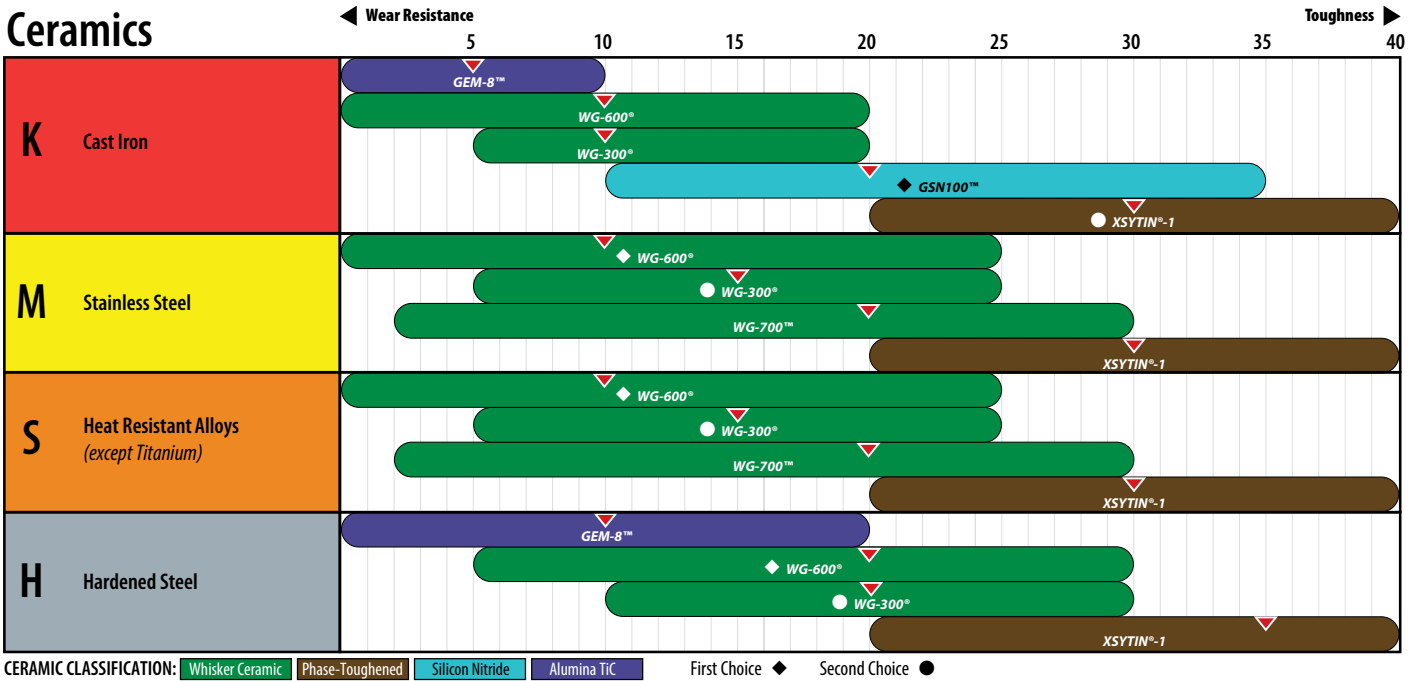

APPLICATION & TECHNICAL INFORMATION

Insert Grade Reference

Ceramic for Milling

Ceramics

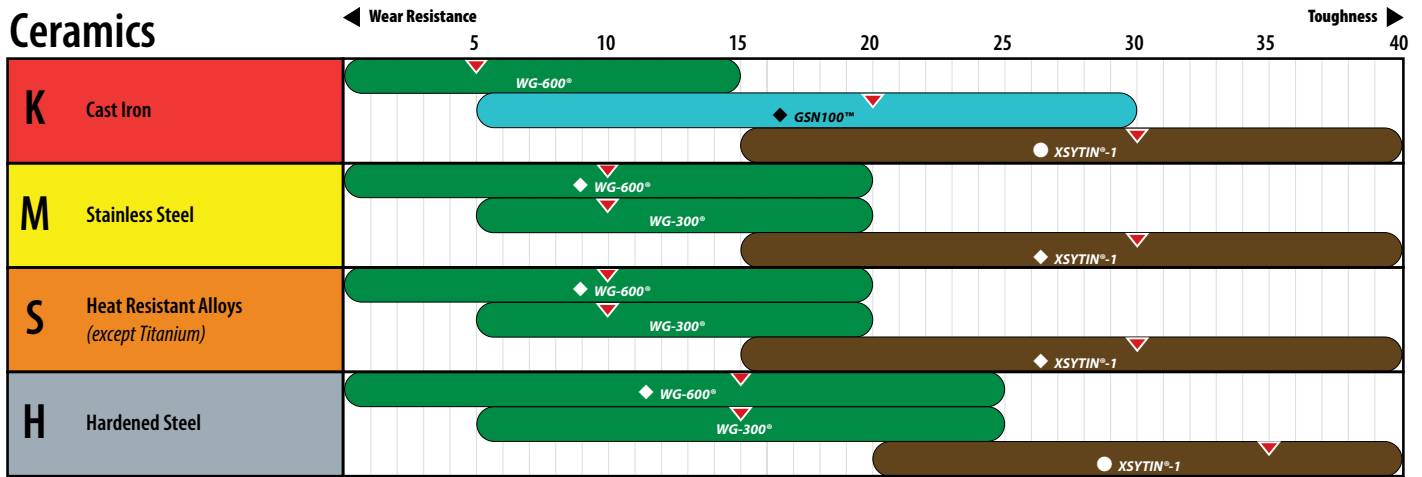

CERAMIC CLASSIFICATION: Whisker Ceramic Phase-Toughened Silicon Nitride Alumina TiC First Choice Second Choice

Steel Roll Turning

with GEM-8™

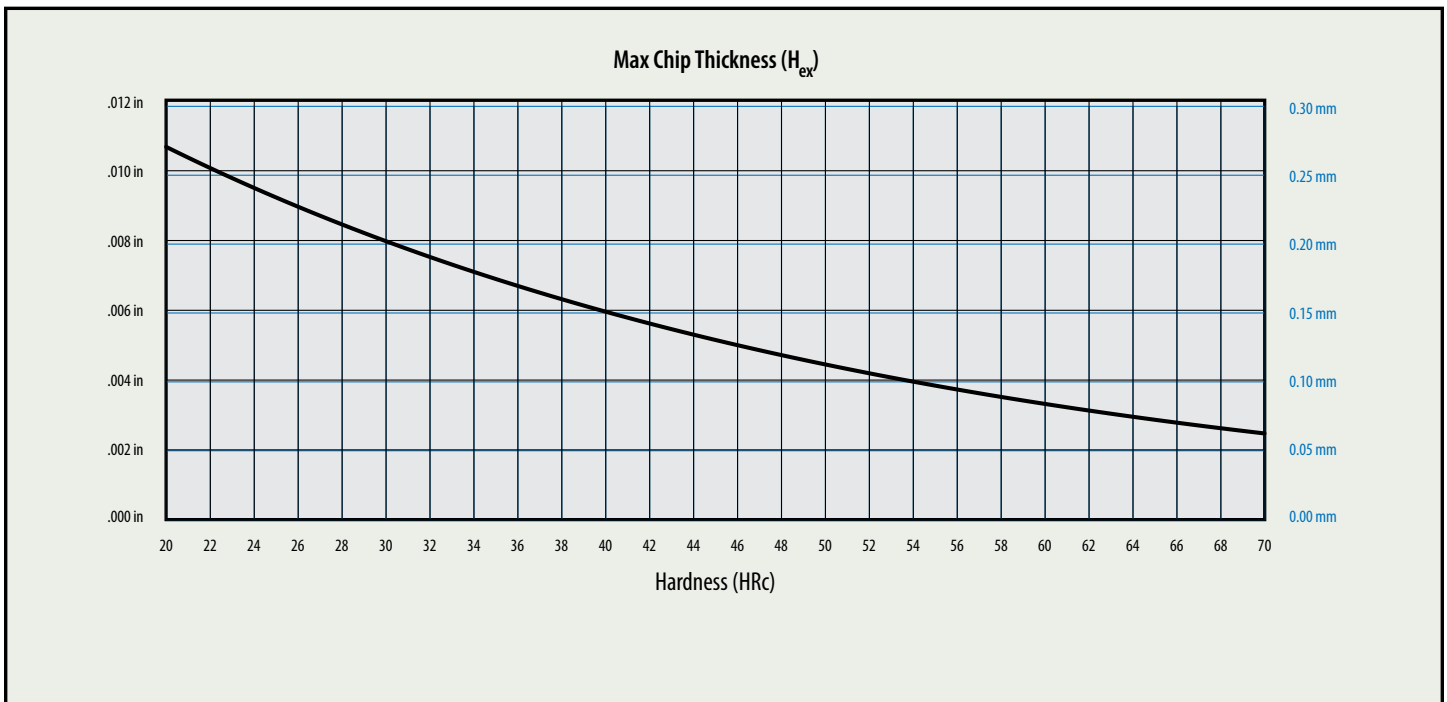
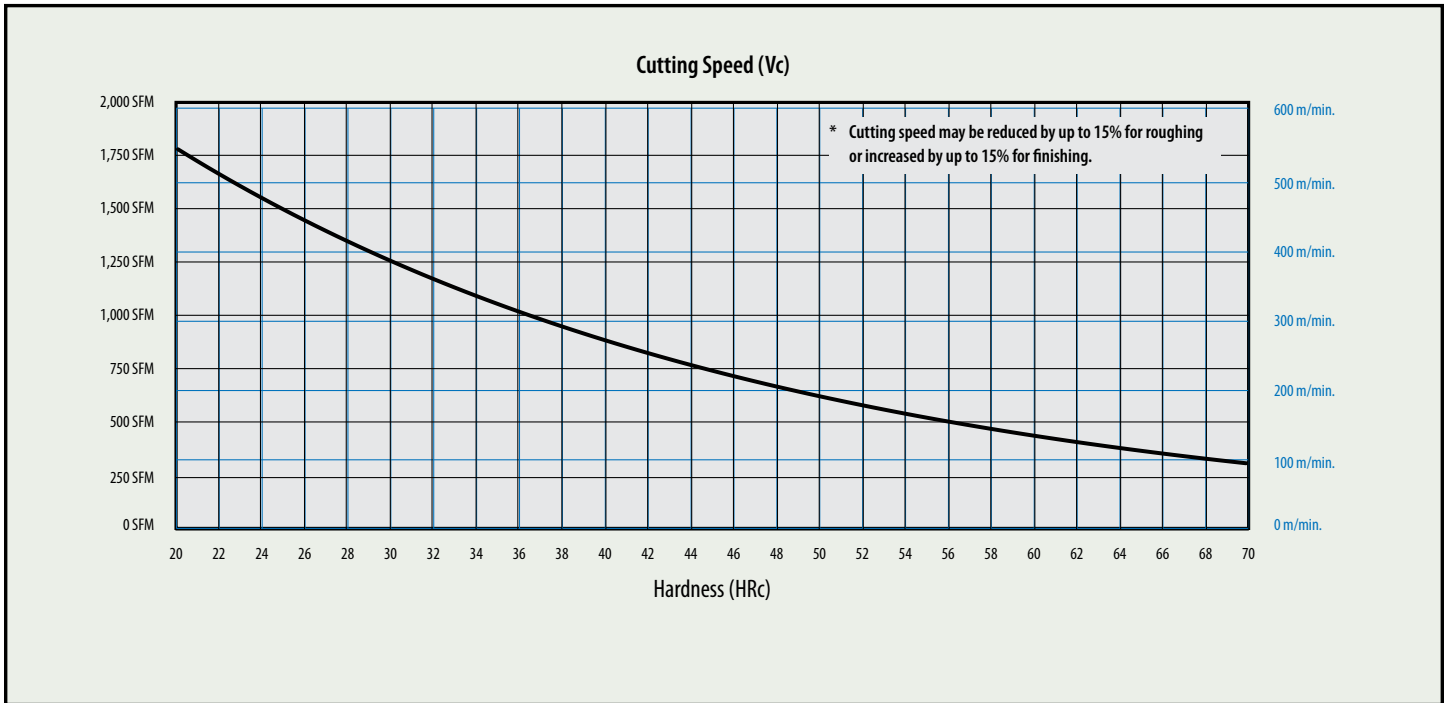

Note: for more recommendations on Cutting Speed and Chip Thickness in turning, see chart on ATI49.

Cast Iron Roll Turning

with GEM-8™

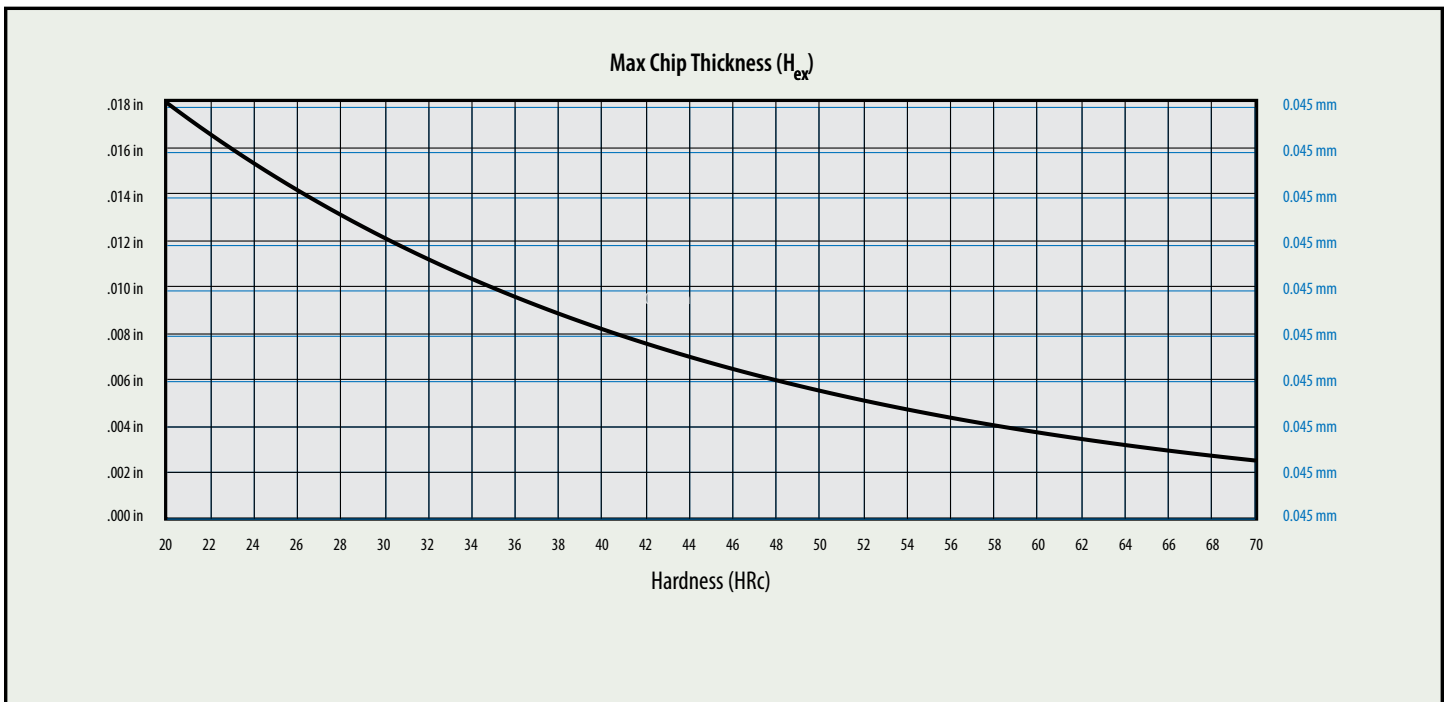
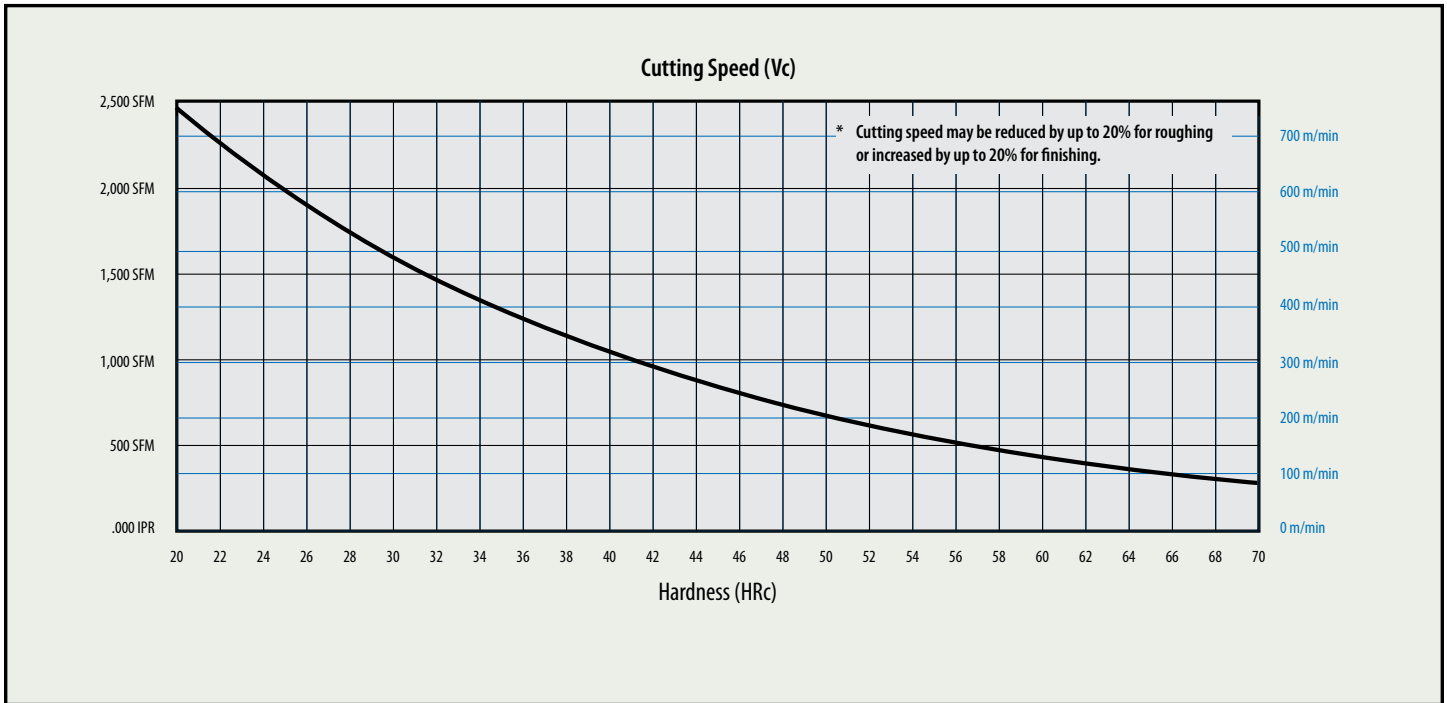

Note: for more recommendations on Cutting Speed and Chip Thickness in turning, see chart on ATI49.

Turning Hardened Steel

with GEM-8™/Whisker-Reinforced Ceramics/XSYTIN®-1

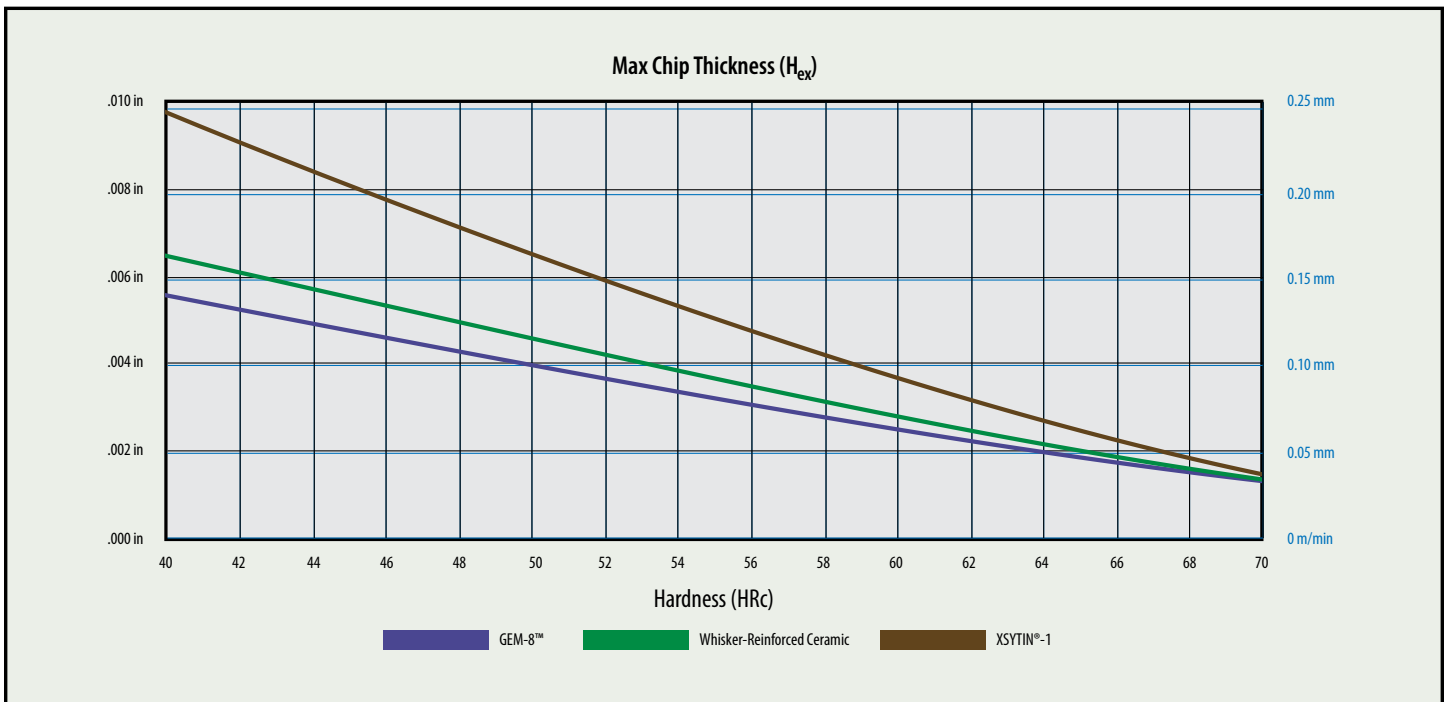
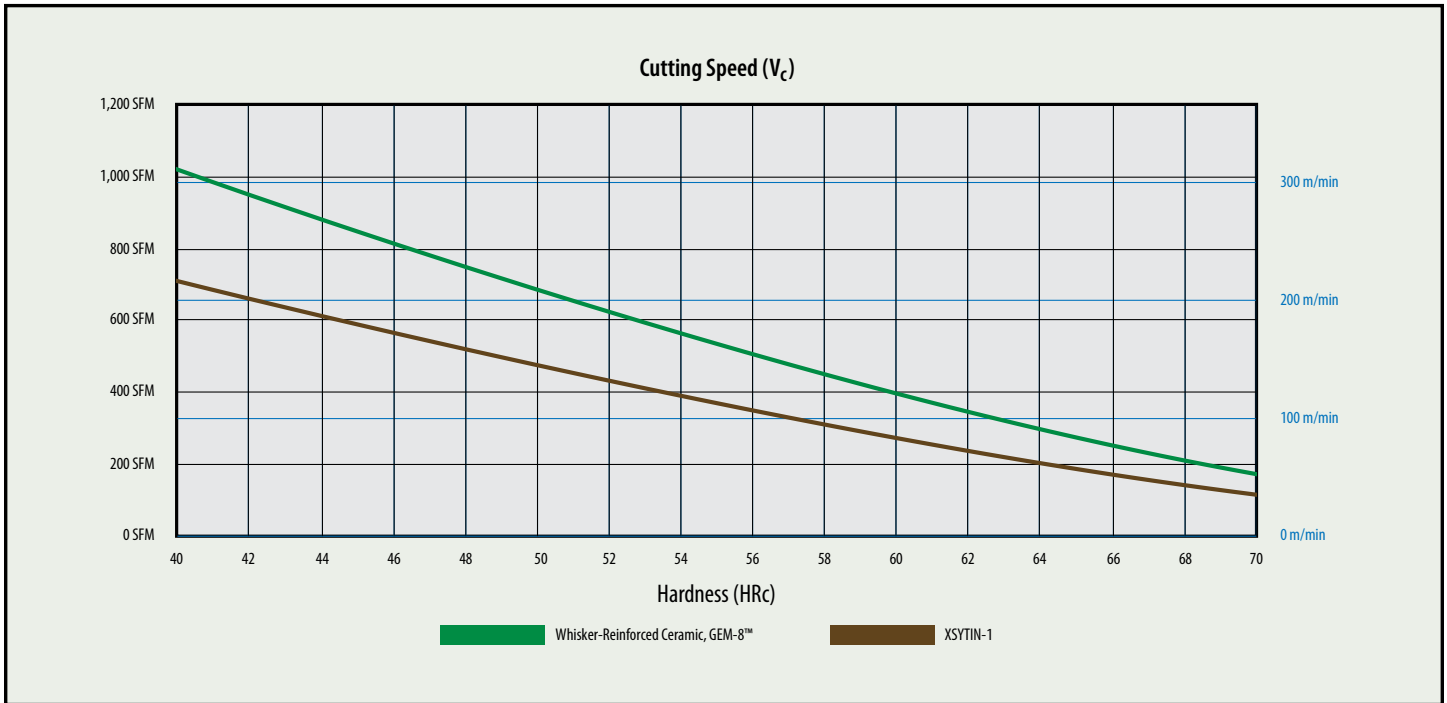

Note: for more recommendations on Cutting Speed and Chip Thickness in turning, see chart on ATI49.

Milling Hardened Steel

with Whisker-Reinforced Ceramics/XSYTIN®-1

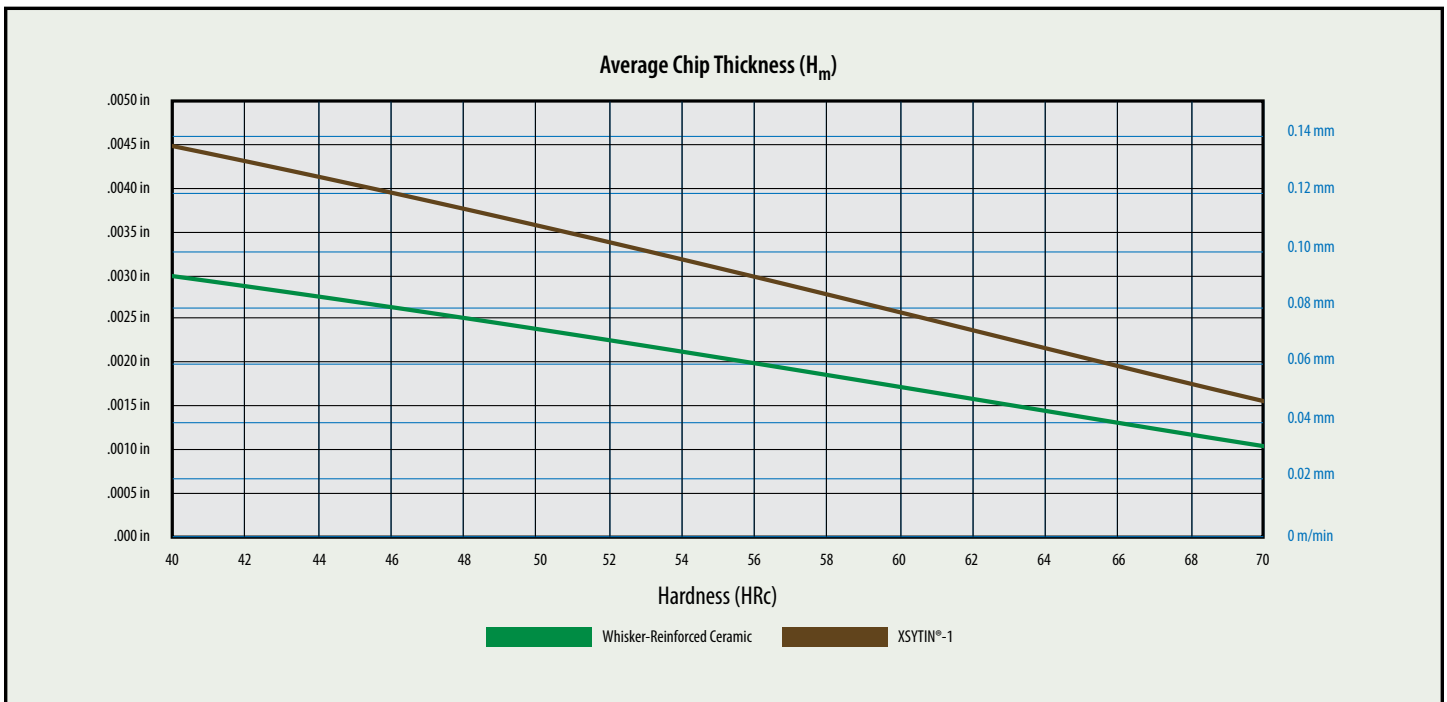
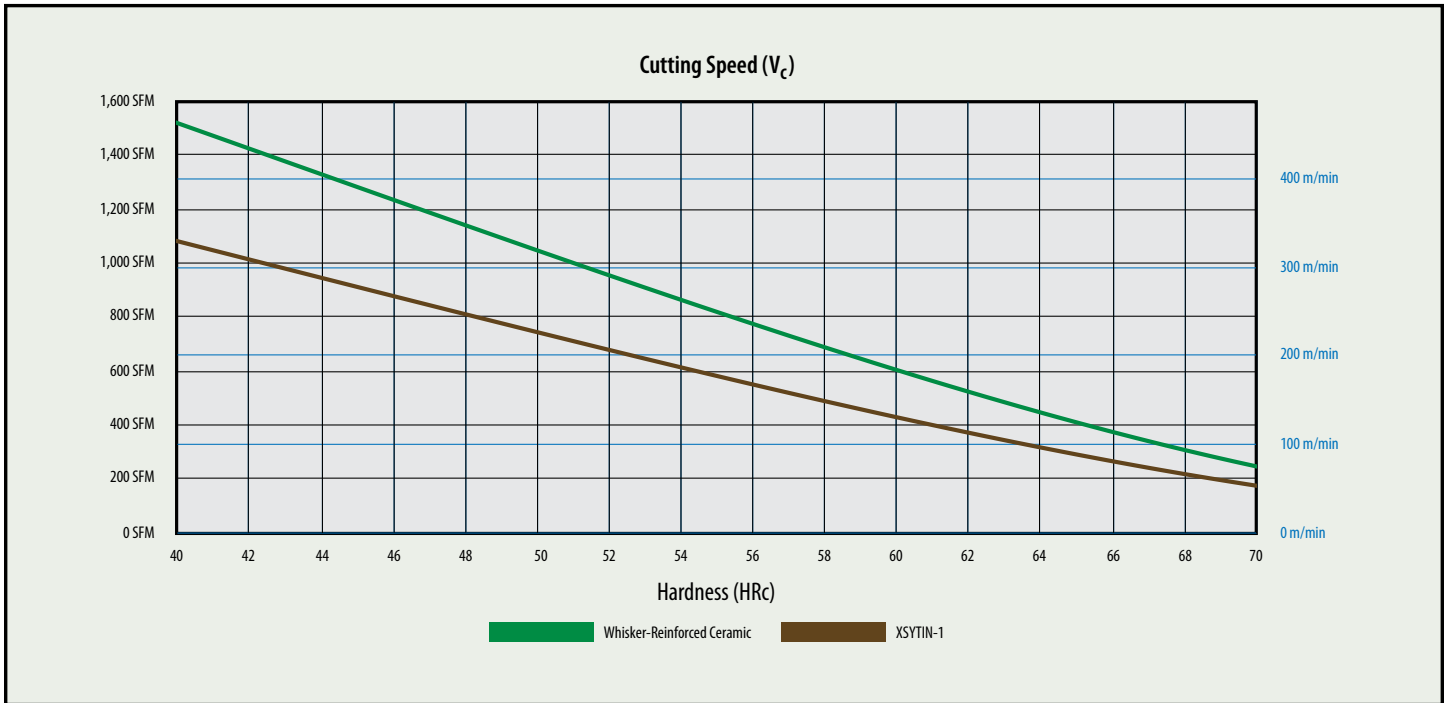

Note: for more recommendations on Cutting Speed and Chip Thickness in milling, see chart on AT174.

Machining Cast Iron

with GSN100™

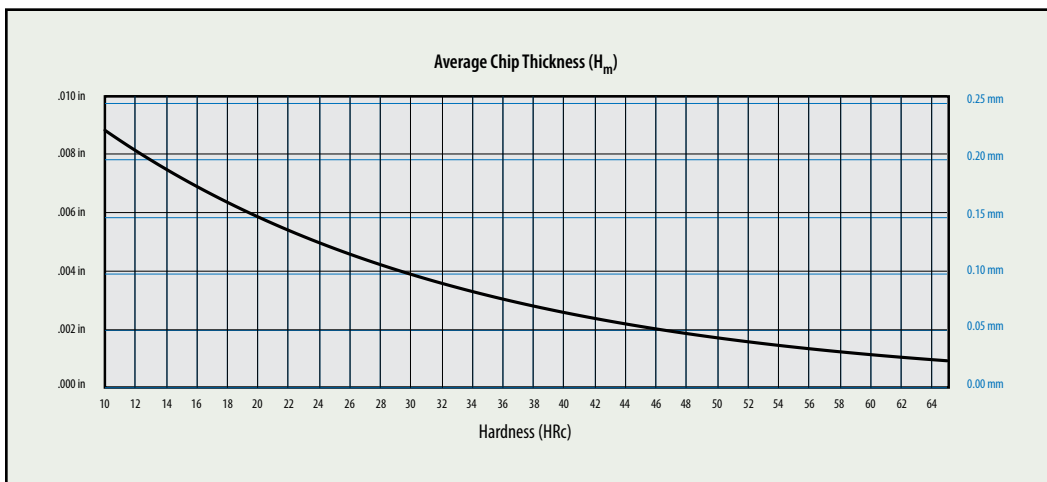
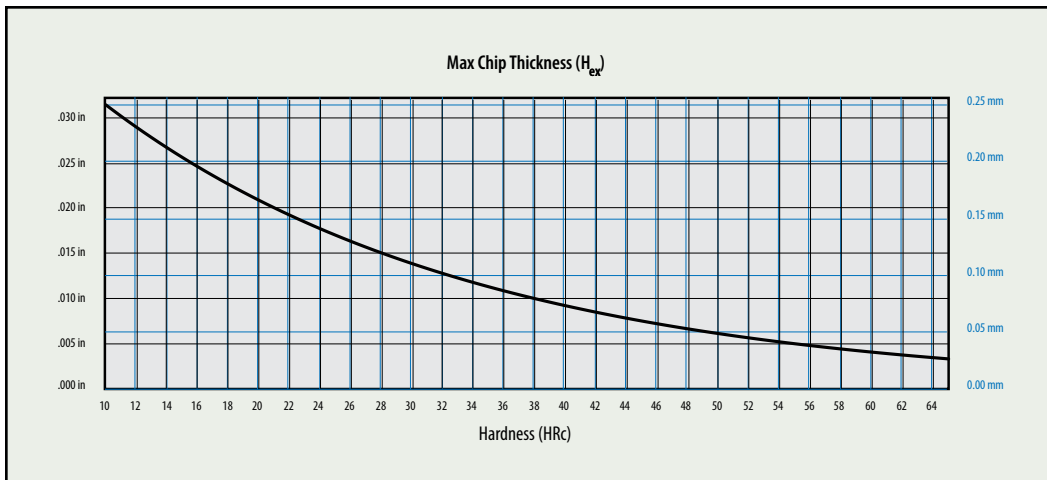
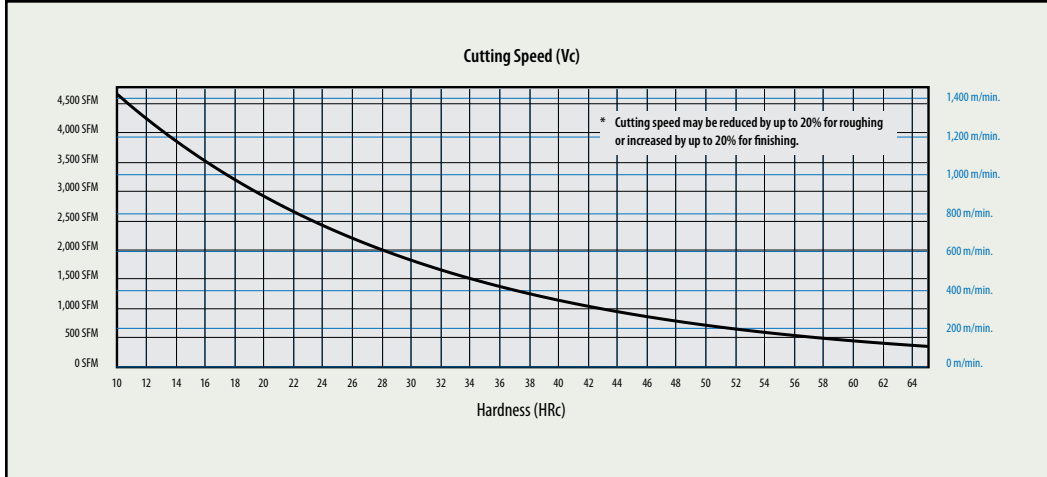

Note: for Chip Thickness recommendations, see charts on ATI49 and ATI74.

APPLICATION & TECHNICAL INFORMATION



Edge Preparations and Application Guide

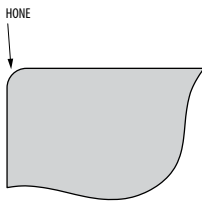

HONE

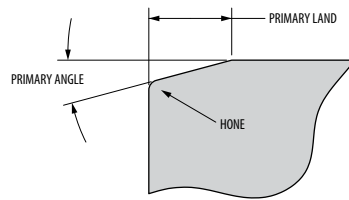

PRIMARY ANGLE

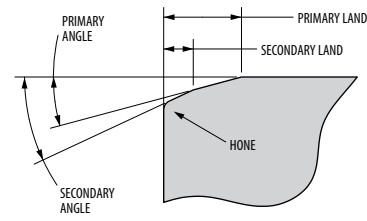

SECONDARY ANGLE

Edge Prep	Hone	Primary Land	Primary Angle	Secondary Land	Secondary Angle	Application
A	0,013 - 0,025mm R					Light hone added to designated lands and chipforms <ul style="list-style-type: none"> • GEM-8™ – Grooving of grey and nodular cast iron • WG-300°, WG-600°, and WG-700™ – Finish turning and grooving of HRSA • GSN100™ – Grooving of grey, nodular, and CGI cast iron • XSVTIN™-1 – General-purpose milling of HRSA, hardened steel, and maraging steel
B	0,025 - 0,051mm R					Large hone used in conjunction with heavy machining chamfers and designated negative lands. Applied where more edge strength and protection from irregular wear is required over A-hone.
T1		0,051 - 0,102mm	20°			<ul style="list-style-type: none"> • WG-300°, WG-600°, and WG-700™ – General-purpose turning of clean HRSA and steel below 50 HRC • XSVTIN™-1 – General-purpose turning and milling of HRSA (especially of a higher hardness) and hardened steel
T1A	0,013 - 0,025mm R	0,051 - 0,102mm	20°			<ul style="list-style-type: none"> • GEM-8™ – Finish-turning of grey and nodular cast iron or hardened steel • WG-300°, WG-600°, and WG-700™ – Light-medium turning and milling of hardened steel, lightly interrupted turning and turning of scale in HRSA, milling HRSA, general-purpose turning and milling of stainless steel • XSVTIN™-1 – Same applications as T1 where the interruption or hardness gradient and size of hard particles are greater - particularly heavy HRSA forging scale turning
T2		0,152 - 0,203mm	20°			Used in the same applications as T1 but at heavier depths of cut and/or heavier feed rates <ul style="list-style-type: none"> • WG-300°, WG-600°, and WG-700™ – Grey and nodular cast iron turning • GSN100™ – General purpose grey, nodular, and CGI cast iron milling
T2A	0,013 - 0,025mm R	0,152 - 0,203mm	20°			<ul style="list-style-type: none"> • GEM-8™ – Light-medium turning of grey and nodular cast iron or hardened steel • WG-300°, WG-600°, and WG-700™ – Grey and nodular cast iron milling, milling of hardened steel, heavy HRSA forging scale turning • GSN100™ – Same applications as T2 where more edge strength and protection from irregular wear is required • XSVTIN™-1 – General-purpose cast iron (including white cast iron, ADI, CGI) turning and milling

APPLICATION & TECHNICAL INFORMATION

Edge Preparations and Application Guide (Continued)

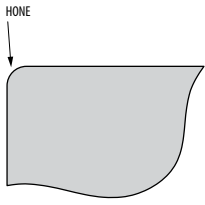

HONE

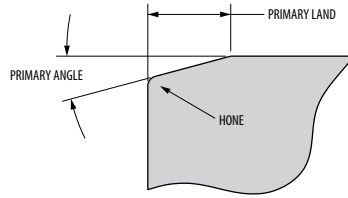

PRIMARY ANGLE

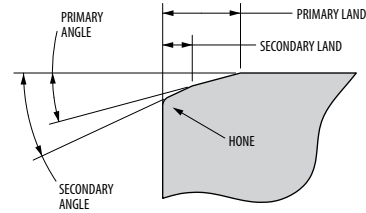

SECONDARY ANGLE

Edge Prep	Hone	Primary Land	Primary Angle	Secondary Land	Secondary Angle	Application
T3		0,330 - 0,381mm	30°			Used on smaller IC inserts as an alternative to T7
T3A	0,013 - 0,025mm R	0,330 - 0,381mm	30°			Used on smaller IC inserts as an alternative to T7A
T4A	0,013 - 0,025mm R	1,90mm	10°	0,17mm	25°	<ul style="list-style-type: none"> GEM-8™ – Medium turning of roll materials and hardened steel WG-300°, WG-600°, and WG-700™ – Medium-rough continuous-interrupted turning of hardened steel and roll materials XSYTIN®-1 – Rough turning of roll materials
T4B	0,025 - 0,051mm R					
T5A	0,013 - 0,025mm R	1,52mm	15°	0,17mm	30°	Same applications as T4A/B where more edge strength and protection from irregular wear is required
T5B	0,025 - 0,051mm R					
T6A	0,013 - 0,025mm R	1,52mm	20°	0,32mm	30°	Same applications as T5A/B where more edge strength and protection from irregular wear is required
T6B	0,025 - 0,051mm R					
T7		0,381 - 0,508mm	20°			<ul style="list-style-type: none"> WG-300°, WG-600°, and WG-700™ – Heavy turning or milling of cast iron or rough turning of particularly abrasive (high Ti, Al) HRSA GSN100™ – Heavy turning or milling of grey, nodular, and CGI cast iron XSYTIN®-1 – Heavy turning or milling of cast iron or rough turning of particularly abrasive (high Ti, Al) HRSA
T7A	0,013 - 0,025mm R	0,381 - 0,508mm	20°			<ul style="list-style-type: none"> GEM-8™ – Medium-rough turning of grey and nodular cast iron. GSN100™ – Same applications as T7 where more edge strength and protection from irregular wear is required
T9		0,152 - 0,203mm	30°			For use with higher feed rates in the same applications as T7
T9A	0,013 - 0,025mm R	0,152 - 0,203mm	30°			Same applications as T9 where more edge strength and protection from irregular wear is required
T10A	0,013 - 0,025mm R	2,290 - 2,540mm	15°	0,17mm	30°	<ul style="list-style-type: none"> GEM-8™ – Rough turning of white cast iron and roll materials WG-300°, WG-600°, and WG-700™ – Rough, continuous-interrupted turning of roll materials
T10B	0,025 - 0,051mm R					

Formulas for Turning and Facing

Imperial

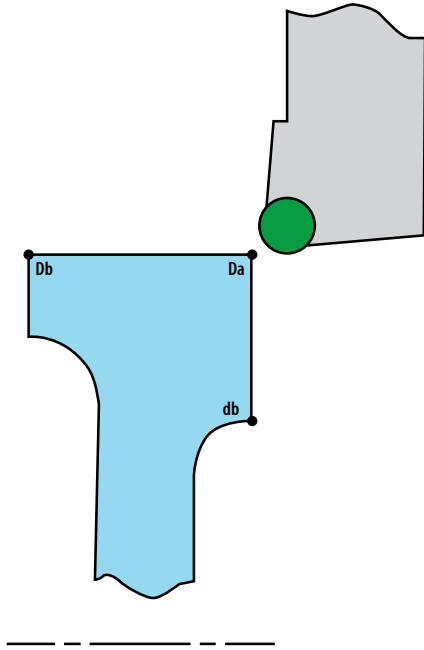

Turning

$$SFM = \frac{Dia. \times \pi \times RPM}{12}$$

$$RPM = \frac{SFM \times 12}{Dia. \times \pi}$$

$$T = \frac{LOC}{IPR \times RPM}$$

$$LOC \text{ Da to Db} = \frac{SFM \times 12 \times IPR \times T}{Dia. \times \pi}$$

Facing

To calculate the time (T) for a facing operation from starting point (Da) to finishing point (db):

$$\text{Time Da to db} = \frac{\pi (Da^2 - db^2)}{48 \times SFM \times IPR}$$

To calculate the endpoint (db) for facing from starting point (Da) to finishing point (db):

$$db = \sqrt{Da^2 - (15.279 \times T \times SFM \times IPR)}$$

If db is minus, you have passed center.

- SFM = Surface Speed (feet/minute)
- IPR = Feed Rate (inches/revolution)
- LOC = Length of cut (inches)
- T = Time (min.)
- π = 3.1416
- D = Large Diameter (inches)
- d = Small Diameter (inches)
- 15.279 = $\frac{48}{\pi}$

Note: The constant speed capabilities of the lathe are assumed in the above facing calculations.

Metric

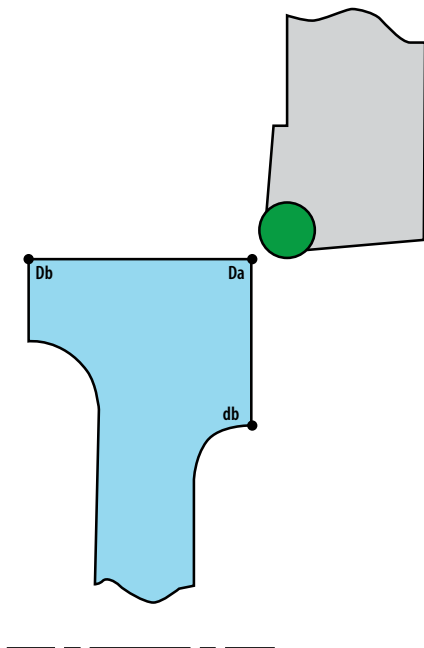

Turning

$$V = \frac{Dia. \times \pi \times RPM}{1000}$$

$$RPM = \frac{V \times 1000}{Dia. \times \pi}$$

$$T = \frac{LOC}{S \times RPM}$$

$$LOC \text{ Da to Db} = \frac{V \times 1000 \times S \times T}{Dia. \times \pi}$$

Facing

To calculate the time (T) for a facing operation from starting point (Da) to finishing point (db):

$$\text{Time Da to db} = \frac{\pi (Da^2 - db^2)}{4000 \times V \times S}$$

To calculate the endpoint (db) for facing from starting point (Da) to finishing point (db):

$$db = \sqrt{Da^2 - (1273,2 \times T \times V \times S)}$$

If db is minus, you have passed center.

- V = Surface Speed (meters/minute)
- S = Feed Rate (mm/revolution)
- LOC = Length of cut (mm)
- T = Time (min.)
- π = 3.1416
- D = Large Diameter (mm)
- d = Small Diameter (mm)
- 1273,2 = $\frac{4000}{\pi}$

Note: The constant speed capabilities of the lathe are assumed in the above facing calculations.

Optional Clamps

To give maximum flexibility and provide for maximum clamping advantage in any given cutting situation, there are alternative clamps available. The variation in these clamps is the reach. Barrel diameters are common.

A typical example of alternate clamp usage would be in holding an insert without a hole. In this case, the lock pin would be removed and the clamp substituted so that maximum top clamping capability may be applied.

We have chosen as standard for each tool cataloged a clamp and differential screw combination for use with inserts with holes (pinlock). A longer reach clamp should be used when using top clamp alone. If conditions indicate, another combination would be advantageous. Please note as follows:

- Clamps CLM6, CLM7 and CLM19 are interchangeable. The difference is in the reach only.
- CLM9, CLM12 and CLM30 are all interchangeable, the difference being in the reach only.
- CLM20 and CLM22 are interchangeable, the difference being in the reach only.

Barrel diameters "B" and thread sizes are common. The reach "C", height "D", and "E" and "G" dimensions may be different. It is very important that sufficient clearance exist in the toolholder for the clamp to drop down far enough into the holder to attain clamping action on the insert.

CLM20 CLM22

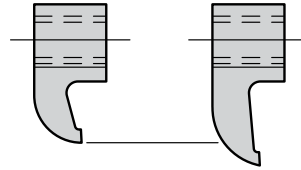

CLM19 CLM6 CLM7

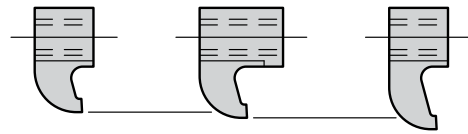

CLM9 CLM12 CLM30

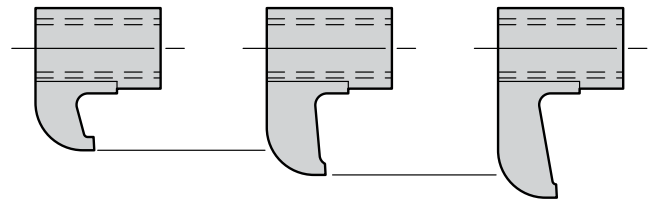

Clamp Interchangeability

Order Number	B	C	D	E	G	Thread
CLM6	7,87	14,73	11,18	4,83	2,29	M5 x 0.8
CLM7	7,87	16,26	7,87	1,65	-	M5 x 0.8
CLM9	10,87	19,05	16,76	8,89	3,05	M8 x 1
CLM12	10,87	22,35	17,53	8,89	3,05	M8 x 1
CLM19	7,87	13,97	7,11	1,65	-	M5 x 0.8
CLM20	9,47	18,54	10,16	3,30	-	M6 x 1
CLM22	9,47	21,59	13,46	7,11	3,30	M6 x 1
CLM24	12,52	25,40	19,81	11,68	3,30	M10 x 1.25
CLM30	10,87	25,40	16,76	8,89	3,05	M8 x 1

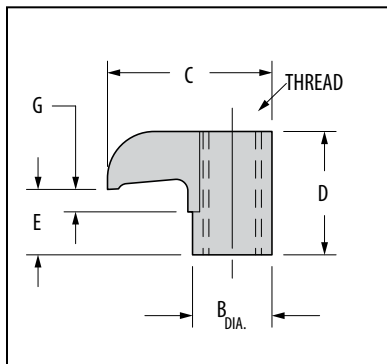



Greenleaf Advanced Ceramics

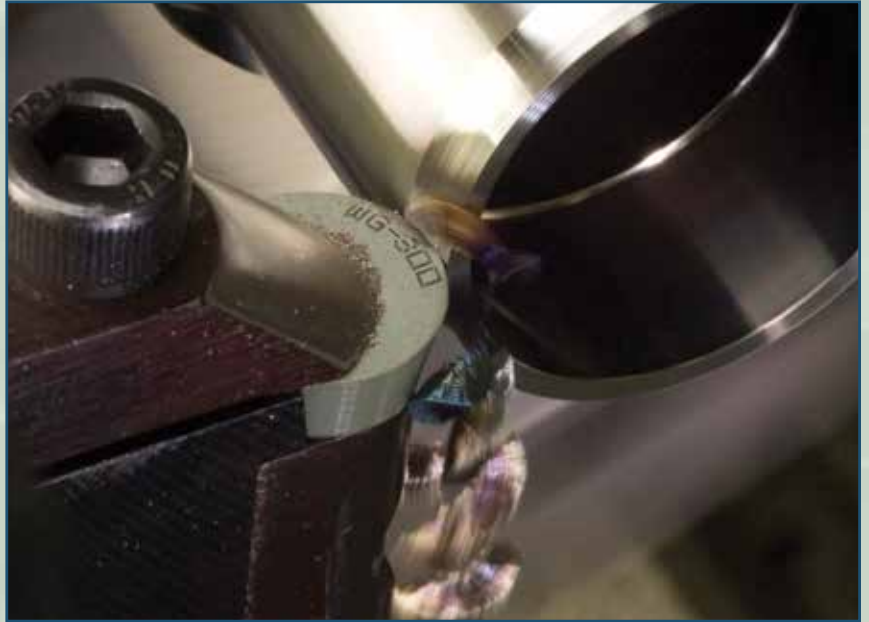

Index

	<i>Page</i>		<i>Page</i>
Glossary	ATI 29	Grooving and Profiling	ATI 63
What are Greenleaf ceramic cutting tools?	ATI 30-31	Profiling	ATI 64
Applying Greenleaf Ceramics	ATI 32	Whisker-Reinforced Ceramics	ATI 64
Application Guidelines	ATI 32	XSYTIN®-1	ATI 64
Tool-Holding Selection	ATI 33	Radial Engagement a.k.a. Wraparound	ATI 65
Insert Strength	ATI 34	Semi-Finishing	ATI 65
Edge Preparations	ATI 35	Fillets and Shoulders	ATI 65
Material Classification and Tool Selection.....	ATI 37	Corners in a Cavity	ATI 66
Heat-Resistant Super Alloys (S).....	ATI 37	Finishing	ATI 66
Hardened steel (H).....	ATI 39	WG-600®	ATI 67
Cast Iron (K)	ATI 43	GF-1	ATI 67
Stainless Steel (M)	ATI 46	Thin-Walled Components	ATI 68
Chip Formation.....	ATI 48	Test Ring Production	ATI 69
Chip Thickness.....	ATI 48	Coolant	ATI 69
Ceramic Wear Patterns.....	ATI 51	Stainless Steel (M).....	ATI 70
Machining Strategy: Continuous and Lightly Interrupted Cuts	ATI 54	Hardened Steel (H)	ATI 70
Material-Independent Guidelines	ATI 54	Cast Iron (K).....	ATI 71
Rake Angles and Clearance	ATI 54	Machining Strategy: Interrupted Cuts and Milling	ATI 72
Mechanical Stresses	ATI 55	Interrupted Turning.....	ATI 72
Heat Distribution	ATI 57	Whisker-Reinforced Ceramics	ATI 72
Cutting Tool Material Properties.....	ATI 57	XSYTIN®-1.....	ATI 72
Material-Specific Guidelines.....	ATI 58	Milling	ATI 73
Heat-Resistant Super Alloys (S)	ATI 58	Material-Independent Guidelines.....	ATI 73
Forging Scale Removal.....	ATI 58	Material-Specific Guidelines	ATI 74
Roughing: Straight Cuts.....	ATI 58	Extended Material Guide	ATI 76
Whisker-Reinforced Ceramics.....	ATI 58	Heat-Resistant Super Alloys (S)	ATI 76
XSYTIN®-1	ATI 62	Hardened steel (H)	ATI 77
Roughing: Opening Cavities.....	ATI 62	Cast Iron (K).....	ATI 77
Grooving.....	ATI 63	Stainless Steel (M).....	ATI 78

Glossary

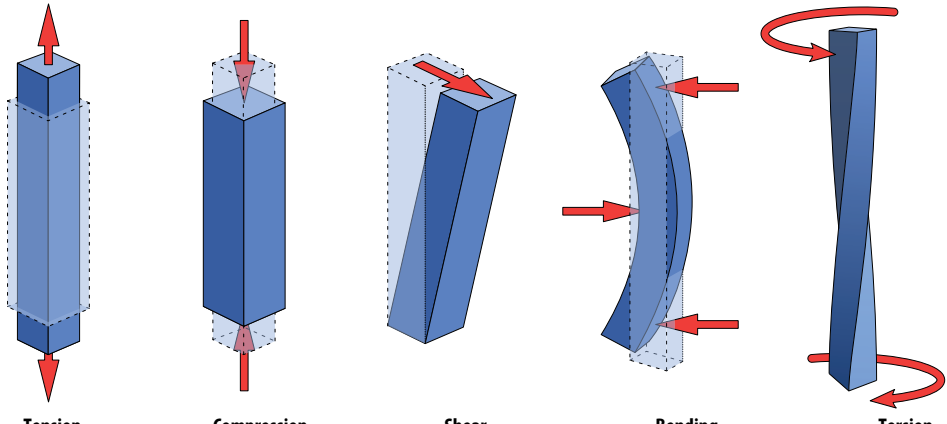
<p>Engineering stress</p>	<p>The state of being loaded in a particular direction, accompanied by deformation a.k.a. strain.</p>  <p style="text-align: center;"> Tension Compression Shear Bending Torsion </p> <p style="text-align: right; font-size: small;"><i>Different types of mechanical stress EN — Creator: MikeRun https://creativecommons.org/licenses/by-sa/4.0/</i></p>
<p>Fracture Toughness</p>	<p>The resistance of a material to crack growth. The single best predictor of regularity of wear and tool life in general for a ceramic cutting tool in a continuous cut.</p>
<p>Oxidation (v. Oxidize)</p>	<p>A mode of corrosion in which elements combine with oxygen to create oxides. Usually something to be avoided because it results in the deterioration of mechanical properties of a material. Rapid oxidation is also commonly referred to as ‘being on fire.’</p>
<p>Plasticization (v. Plasticize)</p>	<p>The action of thermal softening. Most materials lose strength and hardness with increasing temperature, becoming more ductile and requiring lower forces to deform.</p>
<p>Specific Cutting Energy</p>	<p>The energy required to form a chip of unit volume. Varies with material and strain rate.</p>
<p>Strain</p>	<p>Deformation. Can be elastic, in which case the deformation is recovered after the stress is removed, but in this guide, is used almost exclusively to denote the degree of plastic deformation. Can be tensile, compressive, or shear.</p>
<p>Strain Rate</p>	<p>The rate at which something is deformed. The change in the magnitude of strain per unit of time.</p>
<p>Transverse Rupture Strength</p>	<p>Also known as “modulus of rupture”, “bend strength”, or “flexural strength”. A material property, defined as the stress in a material just before it yields in a bending test.</p>
<p>WC-Co</p>	<p>Sintered tungsten carbide, commonly referred to as ‘carbide’ – the most common and widely used cutting tool material. It is usually composed of a substrate and a coating, with substrates varying by grain size, % of Co as binder, and any added carbides (TiC, TaC), as well as gradient sintering, enrichment, etc.</p>

What are Greenleaf ceramic cutting tools?

To answer this question thoroughly we need to start at the beginning – Greenleaf was born in the mid-1940s, as a manufacturer of indexable tungsten carbide and quickly evolved into a recognized toolmaker for the heavy machining industry. After being the first to bring CVD-coated carbide to the US market in 1969 Greenleaf started to develop ceramic cutting tools.

Greenleaf’s first commercially viable ceramic cutting tool – “GemPrest” was introduced in 1973 and constituted a hot-pressed $Al_2O_3 + TiC$ composite. Hot-pressing binds the components of a ceramic cutting tool more strongly than cold-pressing and sintering, increasing its hot-hardness and transverse rupture strength. This method of manufacturing cutting tools, with all the intricacies that were developed and added in the intervening years, continues to set Greenleaf cutting tools apart from the rest regardless of their chemical makeup.

Al_2O_3 in its pure form is a ceramic that is hard, non-reactive, and able to withstand compressive stresses at extreme temperatures, but is also rather brittle – so its uses are limited to a number of specific applications. Reinforcing Al_2O_3 with another material introduces impediments to stress flow, significantly altering its apparent properties. The result is a thermally conductive composite that is tougher, stronger and more resistant to crack growth.

Titanium carbide (TiC) is a very hard ceramic with roughly spheroidal grains and so, mechanically, the reinforcement mechanism is not unlike the reinforcement of cement with gravel to create concrete. The energy a crack must have to go around a TiC grain does not vary significantly with the direction from which the crack approaches the grain. Adding TiC makes the Al_2O_3 matrix more resistant to abrasive wear and stronger in tension, and increases its fracture toughness without sacrificing too much of the original hot-hardness and compressive strength, making it a viable cutting tool. Naturally, much has changed between 1973 and now, and the viability

of TiC-reinforced cutting tools especially when it comes to turning of hard, abrasive iron-based alloys has improved dramatically. As such, GEM-8™ shares little with GemPrest other than the most fundamental chemical constituents – Al_2O_3 and TiC.

Silicon carbide (SiC) is also a very hard material, but single grains can be grown to take the shape of elongated hexagonal prisms commonly referred to as ‘whiskers’ (SiC_w), which makes its reinforcement mechanism very different from that of TiC – closer to the reinforcement of concrete with rebar. Adding SiCw transforms Al_2O_3 to a much greater extent and produces a composite with properties that strongly depart from both pure Al_2O_3 and TiC-reinforced Al_2O_3 . $Al_2O_3 + SiC_w$ was introduced by Greenleaf in 1985 as WG-300® – the cutting tool material that truly marked the beginning of the era of ceramic machining.

WG-300® is the first commercially available ceramic composite using the technology of whisker-reinforcement. These whiskers are grown under carefully controlled conditions and, due to their high purity and lack of grain boundaries, approach the theoretical maximum tensile strength obtainable – on the order of 1 million psi (6,900 MPa). As a direct consequence of the tensile strength of the whiskers, when a crack starts to grow in the Al_2O_3 matrix and encounters a SiCw crystal at some angle to the plane of the crack it must either go around it where it will inevitably encounter another randomly-oriented SiCw crystal (and so on and so forth expending large amounts of energy in the process) or it must force the whisker to be pulled out of the matrix – which also requires a lot of energy. If a crack has insufficient energy to force a whisker to be pulled out it will cause the whisker to deform elastically and, once the force is removed, the whisker which is now under tension will act to bring the two planes of the crack back together. In this manner, the fracture toughness of WG-300® is made unprecedentedly high. High fracture toughness in turn means that WG-300® will wear predictably and consistently in even the most abrasive materials.

Figure 30a
Whisker-Reinforced WG-300®’s Fracture Surface

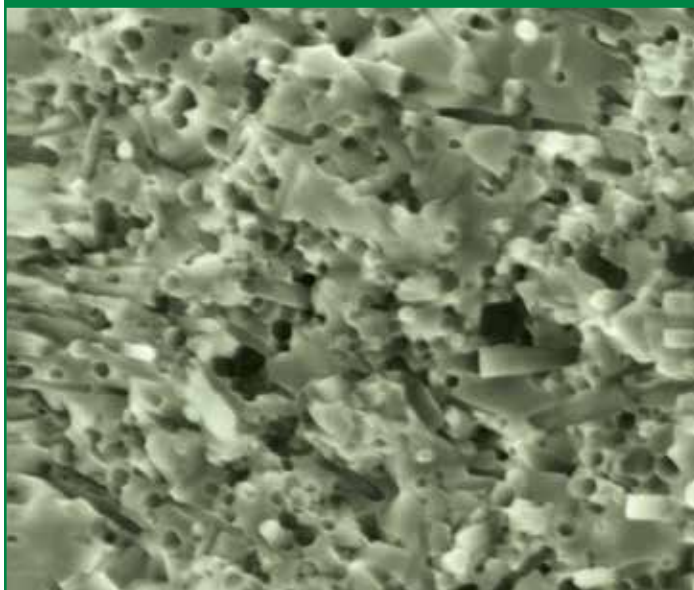

A close examination of the fracture surface at extreme magnification will reveal not only a clear indication of the whiskers randomly dispersed throughout the matrix, but also the obvious hexagonal holes where whiskers have actually been pulled out in the fracture process.

WG-300® properties

Density [g/cm ³]	—	3.74
Hardness Hv (500g load)	—	2100
Transverse Rupture Strength [MPa]	—	690
Fracture Toughness [MPa \sqrt{m}]	—	10.0
Thermal Expansion [10 ⁻⁶ /°C]	—	6.0
Thermal Conductivity [W/mK]	—	35

WG-600® is the first commercially available coated whisker-reinforced ceramic composite. The coating increases the tool’s hot-hardness and serves to further protect the substrate from oxidation and softening, extending tool life.

WG-700™ is the newest whisker-reinforced ceramic composite featuring improved toughness and a unique high-speed coating.

Concurrent with the work on Al_2O_3 composites, Greenleaf was developing another promising type of ceramic – Silicon Nitride (Si_3N_4). In 1986 Greenleaf launched **GSN100™** – a hot-pressed Si_3N_4 -based grade specifically for machining cast iron. Si_3N_4 and SiAlON (silicon nitride with the addition of aluminum and oxygen) ceramics differ from Al_2O_3 composites in a number of ways, but the primary properties that make them viable as cutting tools are their transverse rupture strength and toughness. Without additional strengthening mechanisms their fracture toughness does not begin to approach the fracture toughness of whisker-reinforced ceramics, making most silicon nitride and SiAlON grades currently on the market only suitable for machining grey and nodular cast iron and, in some cases, hardened steel.

XSYTIN®-1 is a Si_3N_4 -based phase-toughened ceramic that exhibits a set of unique material properties that make it the ideal cutting tool for a range of applications previously inaccessible to ceramics. Through the manipulation of grain growth and phase distribution, XSYTIN®-1 attains an internal matrix of interlocked grains, that, together with the inherent properties of Si_3N_4 , result in a reinforced structure that resists the nucleation and growth of cracks in a multitude of materials and machining environments and offers unparalleled transverse rupture strength and resistance to thermal shock. In practice, this means that XSYTIN®-1 is able to withstand unstable conditions with severe hardness gradients, interruption, or inclusions, or else support a very high chip load in clean cuts without notching. Because of its toughness and transverse rupture strength, applying XSYTIN®-1 outside the (very wide) envelope of recommended cutting conditions will not lead to catastrophic failure – rather the tool will top-slice until a deep notch forms, but will continue to cut while wearing in this fashion. When applied within the envelope of recommended cutting conditions XSYTIN®-1 will exhibit gradual flank wear with little to no notching in the majority of known heat-resistant super alloys, steels, hard cast irons, etc.

Figure 31a
XSYTIN®-1 Fracture Surface

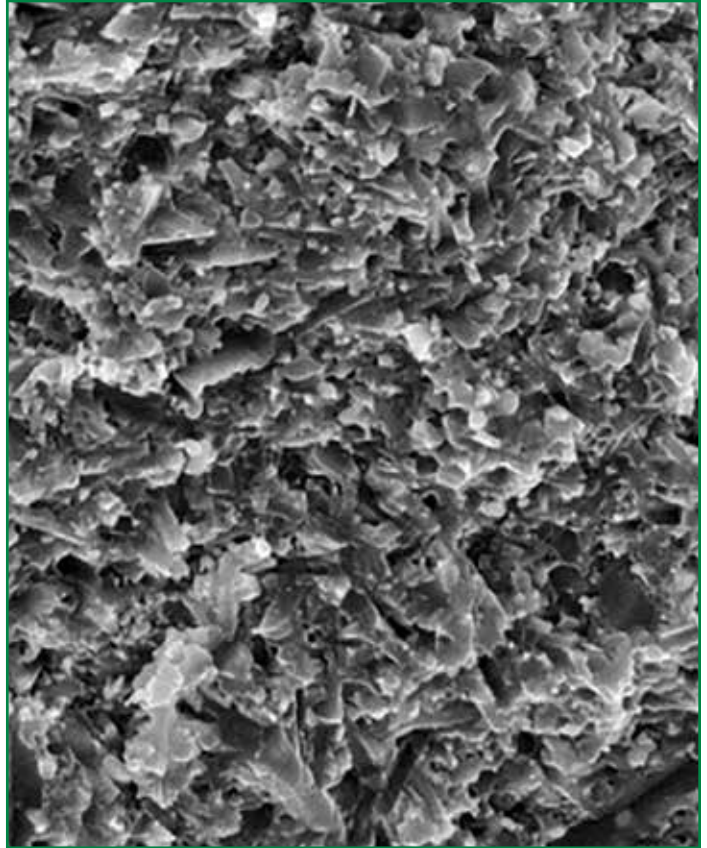

XSYTIN®-1 properties

Density [g/cm ³]	—	3.55
Hardness Hv (500g load)	—	1830
Transverse Rupture Strength [MPa]	—	1200
Fracture Toughness [MPa \sqrt{m}]	—	7.5
Thermal Expansion [10 ⁻⁶ /°C]	—	3.5
Thermal Conductivity [W/mK]	—	26

Applying Greenleaf Ceramics

All cutting tools exploit the fact that at a certain elevated temperature the hardness of the cutting tool is still higher than the hardness of the material being machined, and its strength is sufficient to withstand the mechanical loads the cutting tool is subjected to in the course of machining. The difference in hardness allows using the cutting tool to deform the workpiece material until it fails – forming a chip. The effect of the heat generated in cutting is two-fold:

1. Heat produced in the workpiece plasticizes (softens) the material ahead of the cut, reducing the strength of the material, making it easier to cut
2. Heat conducted into the tool plasticizes the tool, reducing its hardness, strength, and adversely affecting tool life

Higher temperatures also tend to raise the reactivity of both cutting tool and workpiece and make it more likely that either will oxidize or otherwise chemically interact.

Heat in cutting is generated through the following actions in descending order of relative magnitude:

1. Chip formation, which, depending on the material being machined and the geometry of the cutting tool will cause the material to fail in some combination of shear and tension with ductile metals failing almost exclusively in shear.
2. Friction between the chip and the cutting tool
3. Friction between the cutting tool and the workpiece

Unlike carbide, ceramics retain strength and hardness at temperatures far exceeding 800°C (1472°F). This property allows for much higher cutting speeds than those of carbide, an attribute that ceramic cutting tools became known for in the machining of heat-resistant super alloys, hardened steel, and various cast irons. The generated heat is dissipated as shown above with the chip carrying away the majority of the heat but the heat produced ahead of the cut plasticizes the material to a much greater extent than in carbide machining, lowering its strength and reducing the specific cutting energy.

In addition to the chosen cutting speed, feed, and depth of cut, the following factors contribute to heat generation:

1. Chip formation
 - a. Material: ductility, shear strength and how they vary with strain rate and temperature
 - b. Tool:
 - i. Macro-geometry: rake angles, cutting edge profile (e.g. extent of curvature)
 - ii. Micro-geometry: edge preparation, chipform
2. Friction between the chip and the cutting tool
 - a. Coefficient of friction between the workpiece material and the cutting tool
 - b. Rake angles, cutting edge profile
 - c. Coolant composition and pressure
3. Friction between the cutting tool and the workpiece
 - a. Coefficient of friction between the workpiece material and the cutting tool
 - b. Clearance between the flank of the tool and the workpiece as affected by the orientation and macro-geometry of the tool and geometry of the workpiece

Figure 32a
Heat Distribution in Ceramic Machining

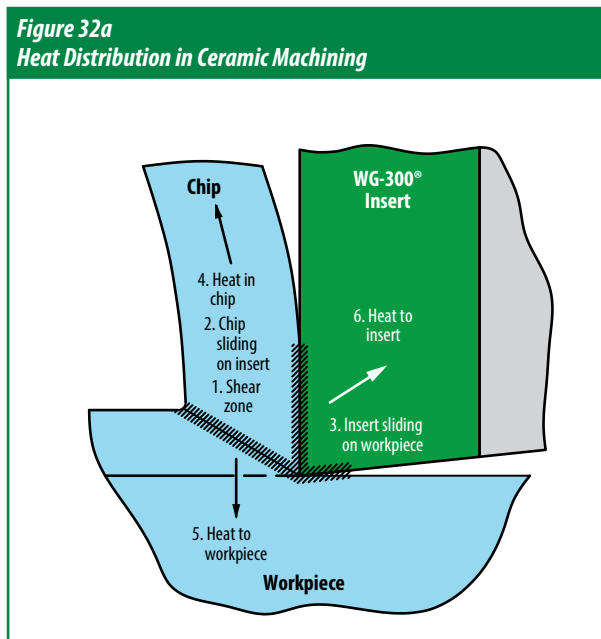

This heat is then dissipated through:

1. Transport away from the cutting zone in the chip
2. Conduction into the workpiece
3. Conduction into the tool

The highest temperature in a metal-cutting operation is typically seen at the very edge of the cutting tool – both in the case of tungsten carbide (WC-Co) and ceramic tools. The main difference between carbide and ceramic cutting tools is how high this temperature can be.

Application Guideline

1. Use the right tool holder, minimize tool deflection
2. Use the strongest insert possible
3. Use the right edge preparation
4. Use the right grade
5. Use the right cutting conditions
6. Optimize the machining strategy and tool path

Tool-Holding Selection

The term ‘tool’ usually refers to that part of the system which interacts with the workpiece to form a chip. When using a solid endmill, the endmill is the tool and the adapter that allows the endmill to be fixed in the spindle is the tool holder. In indexable tooling systems then, the insert is the tool and the milling cutter or turning holder are the tool holder.

Having chosen a tool holder that fits the geometry of the feature being machined (has enough reach to remove all of the programmed stock and enough clearance to avoid collisions), the number one concern when applying ceramics becomes rigidity. The cutting forces generated in ceramic machining are significantly higher than those in carbide machining, and the tool holder provides the interface through which these forces are transferred from the insert to the machine. It is necessary to use the most rigid tool holder and fix it in a manner that will minimize deflection. Any amount of deflection may lead to vibration. High-frequency loading, made higher by the speeds at which ceramics are applied, is extremely detrimental to the tool life of ceramics.

Increasing overhang of tool holders can produce dramatically unfavorable results. For the same cutting force, tool holder material, and cross-section having twice the overhang will result in an eight-fold increase in deflection! Increasing the cross-sectional area of the holder will increase its rigidity and reduce deflection. In practical terms, this means that the larger the cross-sectional area of the tool holder and the shorter the distance between the cutting edge and where the tool holder is attached to the machine (tool hangout) – the less deflection and the lower the detrimental effects of vibration. Whether it is audible or not – microvibration is a phenomenon that is not easy to detect or manage other than through meticulous observation and analysis of wear, or the use of specific measuring equipment in the course of machining.

Most notably, minimizing deflection must be considered when:

1. Using boring bars

Boring bars operate with much greater length-to-diameter ratios than turning tools. In this case, “heavy” metal or solid-carbide bars are often easily justified. Solid-carbide boring bars have three (3) times the modulus of elasticity (E) of a steel bar. This means that a carbide bar will only deflect 1/3 as much as a comparable steel bar under identical circumstances.

As a general rule, when machining nickel-based alloys, steel boring bars will give adequate performance at hangout-to-bar diameter ratios of up to 3:1. Special boring bars manufactured from “heavy” metals give an advantage over steel bars and can be used at ratios up to 5:1. Carbide boring bars extend this range to ratios up to 7:1. See Figure 33a.

2. Mounting shell-style milling cutters on an arbor or endmills in a longer holder

For shell-style milling cutters use an arbor of the largest diameter possible, ideally at least as large as the diameter of the mounting surface of the cutter, and the smallest length possible. For endmills – use the shortest holder possible.

Generally speaking, having a larger contact area between the tool holder and the spindle/turret is also beneficial. So a 50 taper is better than a 40, and fixing a square

Figure 33a
Shank Diameter-to-Bar-Length Ratio
for Ceramic Inserted Boring Bars

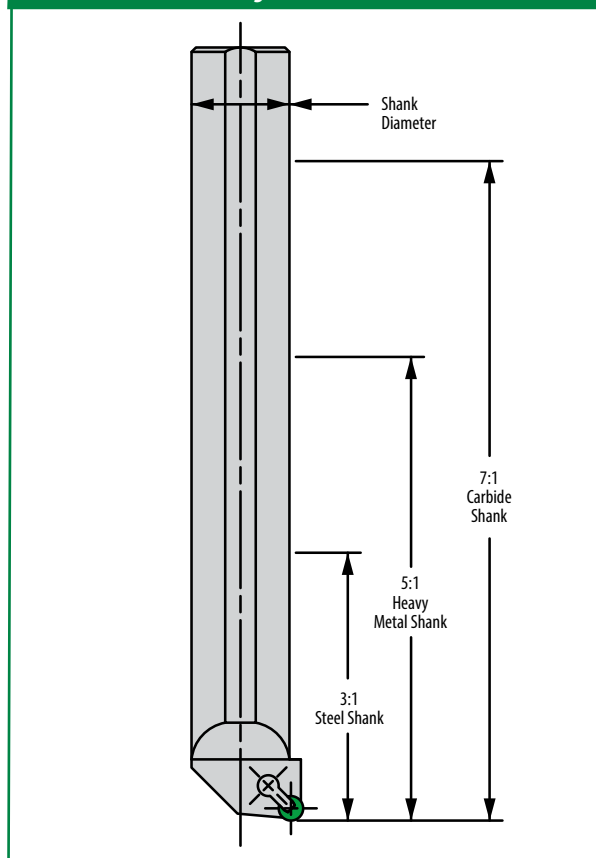

turning holder so that it is pushed as far into the turret as possible is better than having any of the tool hanging out for no reason.

Tool holders designed for ceramic inserts differ significantly from those designed for carbide and Greenleaf tools for ceramic inserts may differ from those produced by another manufacturer. These differences may be as follows:

1. Tolerances and shape of pocket and/or shim leading to incorrect insert seating, and incorrect distribution and transfer of stresses
2. Clamping / fixation leading to incorrect distribution and transfer of stresses
3. Rake angles that are not optimal for ceramic machining

Any of the above may lead to irregular wear or catastrophic failure on their own. Put together – poor tool life is almost guaranteed. Ceramic inserts should NOT⁽¹⁾ be used in a tool holder designed for carbide regardless of the manufacturer in question, and Greenleaf ceramic inserts should only be used in Greenleaf tool holders for ceramics – designed specifically and uniquely to extend tool life of ceramic inserts.

Finally, use integral tool holders whenever possible – modular tool holders add flexibility for usability in multiple applications, but add degrees of freedom that increase the potential for deflection and additional vibration.

⁽¹⁾ The only set of circumstances in which using a ceramic insert in a carbide holder could be considered is if there is no way to replace the tool, the cut is fairly light, and the ceramic in question is XSYTIN[®]-1. And even then – regular wear would not be expected.

Insert Strength

The magnitude of the stresses that an insert is able to carry without failing are not only material-dependent, but also directly related to its geometry—its thickness, shape, and corner radius. Ceramic materials with higher (transverse rupture) strength can be applied in more fragile configurations.

Thickness:

Increased insert thickness results in better impact resistance, heat dispersion, and tool life, particularly in roughing, where light irregular wear is acceptable but may cause a thinner insert to fracture, but generally in any stage of machining.

Figure 34a
Relative Strength for Various Insert Thicknesses

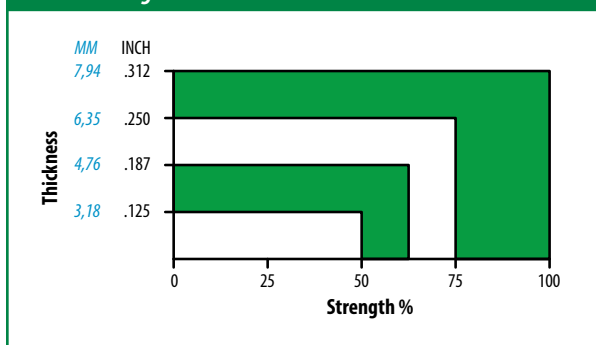

Corner radius:

The larger the corner radius, the stronger the corner. Do not attempt to do all roughing operations with a small corner radius just because the finished fillet calls for a small radius. Use a round insert or large radius insert for roughing and change the tool for the final cuts.

Figure 34c
Relative Strength for Various Insert Radii

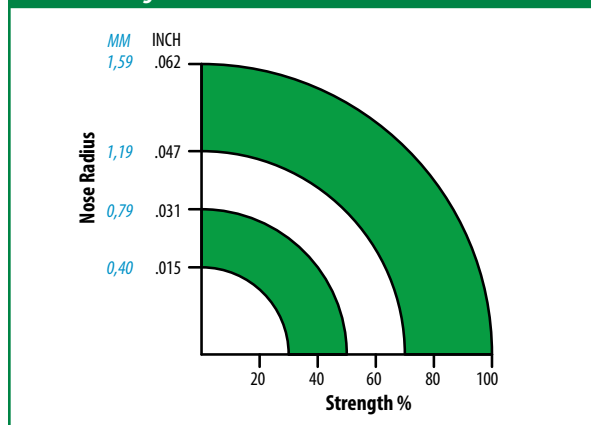

Shape:

In declining order of corner strength, the strongest inserts are: Round, 100° Diamond, Square, 80° Diamond, Triangle, 55° Diamond, and 35° Diamond. A pin-lock style insert – an insert with a hole (e.g. RNGA, SNGA, CNGA, DNGA, VNGA) is always weaker than an insert that is solid. Pin-lock style inserts should only be used when cutting forces are low, the cut is continuous, and tolerances are of primary importance – as in finishing operations. Inserts with increased flank clearance (e.g. RCGN, RPGN, SPGN, VCGN) are also weaker than negative inserts, but they are typically used with different rake angles, so the chip isn't as strongly sheared and the cutting forces are lower.

Figure 34b
Insert Shapes and Strengths

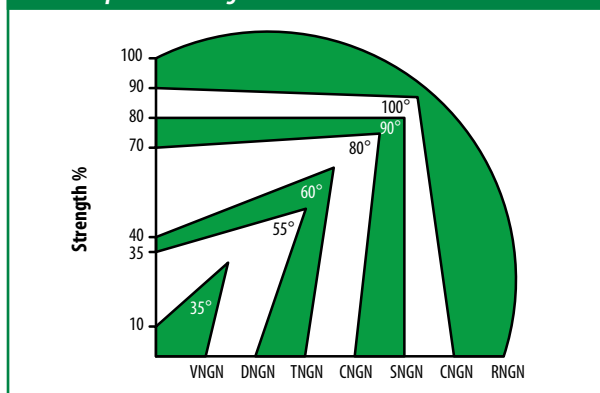

Edge Preparations

Figure 35a
Standard Edge Preparations

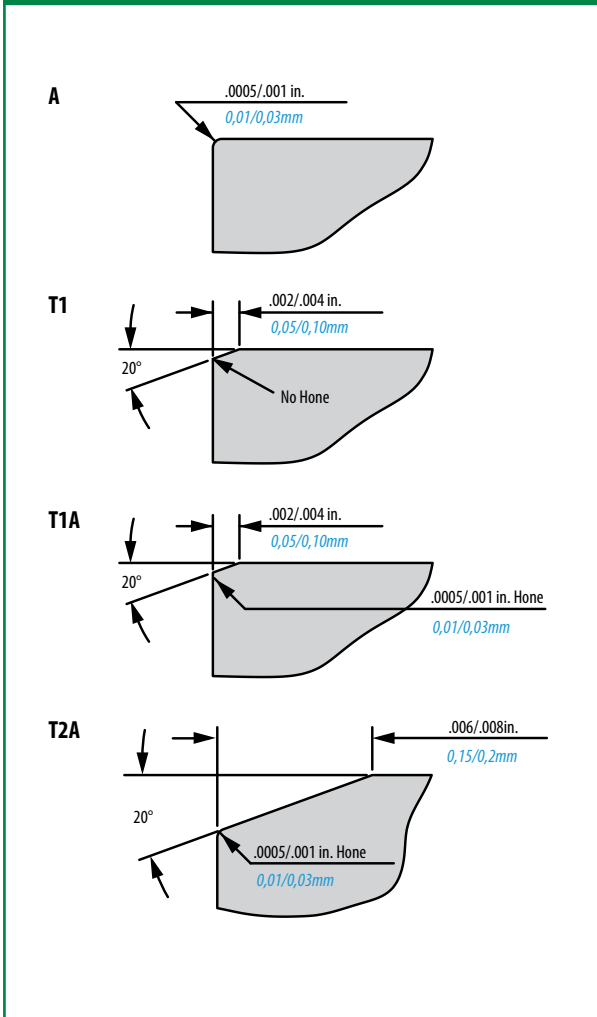

Unlike tungsten carbide (WC-Co) inserts whose edge is typically only honed, where the shape and size of the hone are quite important, ceramic inserts commonly require a chamfer (“upsharp” ceramic inserts without a hone or chamfer are generally not recommended). The size and angle of the chamfer(s) with respect to the rake face of the insert and the size of the hone define the edge preparation.

Hones on ceramic inserts are applied for the same reasons that hones are applied on carbide – to protect the edge from microchipping which then leads to uneven heat and stress distributions and may reduce tool life. Some applications, however, do not require a hone. The most common example of such would be the use of the T1 edge preparation on WG-300®, WG-600®, WG-700™ in clean turning of Inconel 718 – something made possible by the exceptional fracture toughness of WG-300®.

The choice of edge preparation depends on a number of factors, among them:

1. The transverse rupture strength and fracture toughness of the ceramic cutting tool material
2. The extent of variation of mechanical stresses in the course of machining: is the cut continuous or interrupted? How heavily interrupted? Are the fixture, part, and tool sufficiently rigid or prone to deflection? Are the spindle bearings worn and likely to encourage vibration?
3. Chip formation: does the chip separate well or is the material quite ductile and retains a large range of plastic deformation at high strain rates? In other words, is the chip typically continuous (e.g. nickel-based alloys), discontinuous (e.g. cast iron), or cyclical (e.g. titanium)? Is the material being machined homogeneous or not (e.g. large particles of a very high hardness embedded in a softer matrix; multiple phases that respond differently to high strain rates)?

Figure 35b
Edge Prep Effect on Chip Formation

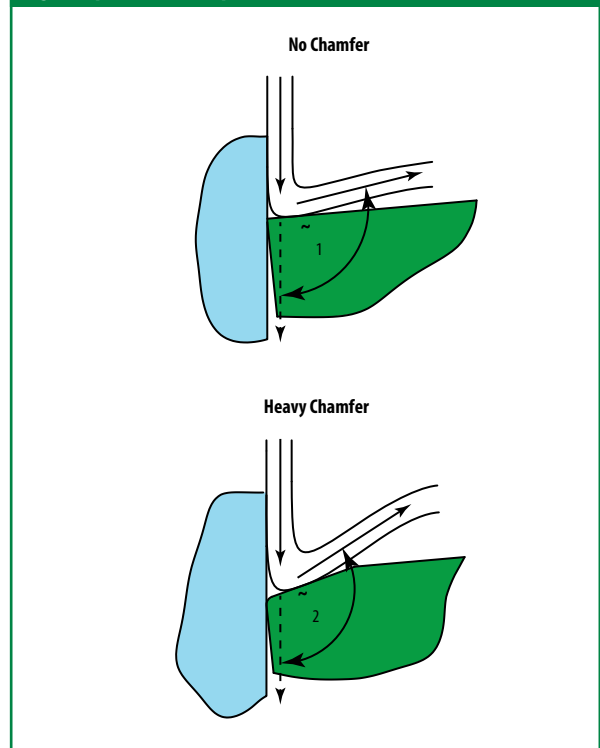

The edge preparation also affects chip formation, in that a chamfer will force a ductile chip through a greater change in direction (i.e. higher strain rate) increasing the degree to which the surface layer of the material is deformed in producing a chip, generating more heat and higher cutting forces. $\alpha_2 > \alpha_1$

A chamfer redirects some of the mechanical stresses so that a part of what would load the insert in bending instead loads it in compression. The compressive strength of ceramics is substantially higher than their tensile strength so that, when appropriate and necessary, a chamfer can be used to protect the edge from irregular wear such as chipping or top-slicing if the static loads or impact encountered in the course of machining locally exceed the strength or toughness of the cutting tool.

Figure 36a
Edge Prep Effect on Tool Stress

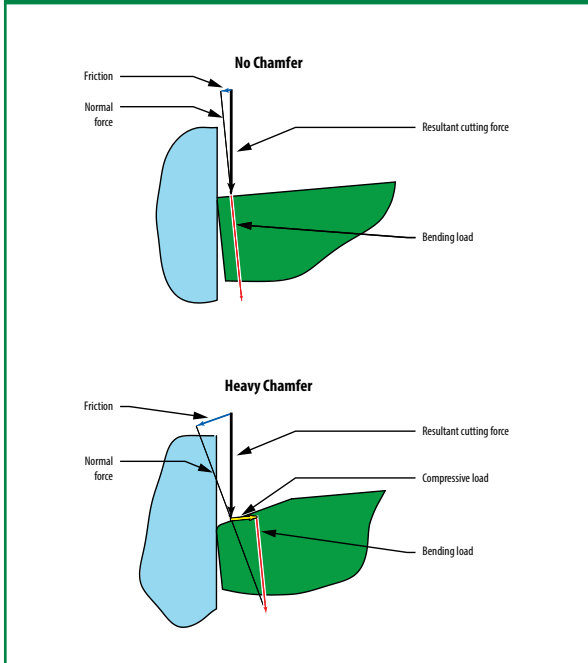

The same logic applies to increasing rake angles for negative inserts, which is one reason why standard Greenleaf tools for negative ceramic inserts have -10° side rake instead of the -5°-6° common in toolholders for WC-Co.

Figure 36b
Toolholder System

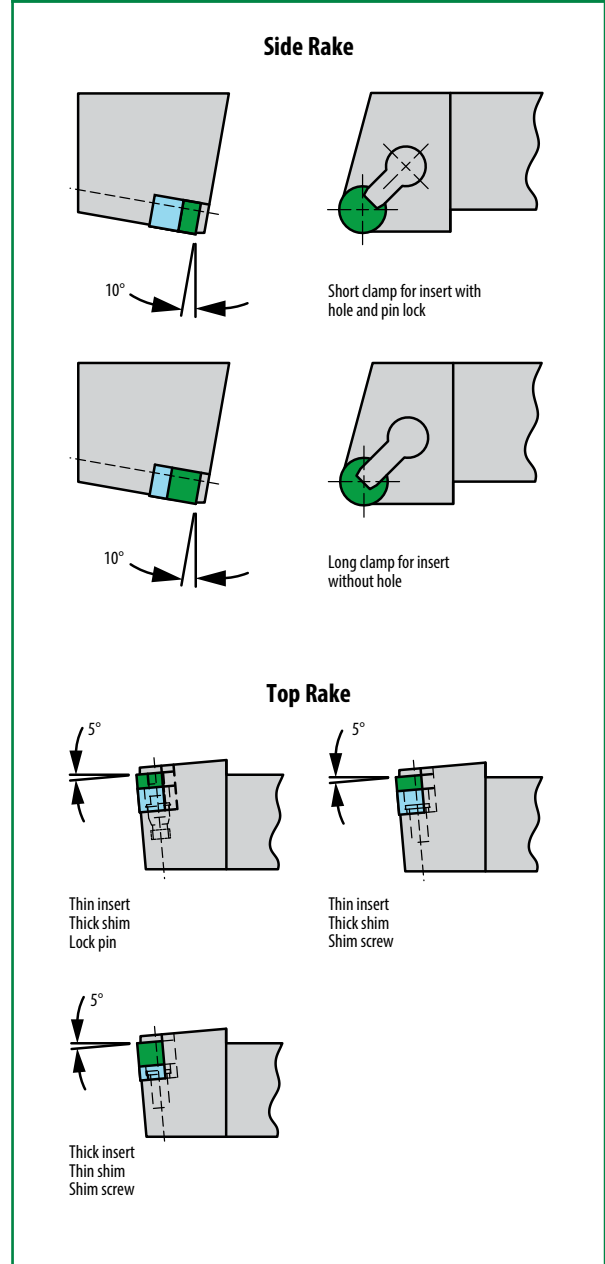

Selecting the appropriate edge preparation for the given combination of workpiece material, type of machining, and cutting tool material is paramount to the stability of the machining process and optimal tool life.

**See pages AT1 22-23 and the following section
on material-specific tool selection for more details.**

Material Classification and Tool Selection

Use the tables that follow as a guide.

The grade and edge preparation recommendations below are not definitive and should not be considered final. You may need to apply other grades and edge preparations to optimize the process.

However, based on decades of ceramic application history, the information in the tables provides the best starting point.

For additional information on materials, grades, edge preparations, and other product application data, please contact Greenleaf Technical Service.

For the purposes of the remainder of this guide, we will divide all materials commonly addressable with ceramics into groups that closely follow ISO material definitions and sub-groups as follows:

- Heat-resistant super alloys S
(corrosion-resistant 1, high-strength 2, wear-resistant 3)
- Hardened steel H (Fe base, C <2%)
(carbon and alloyed 1, maraging 2, tool steel 3, nitrided and/or carburized 4)
- Cast iron K (Fe base, C >2%)
(lamellar 1, nodular 2, CGI 3, white 4, ADI 5, nitrided and/or carburized 6)
- Stainless steel M (Fe base, Cr >10%)
(austenitic 1, martensitic 2, super-austenitic 3, duplex 4, PH 5)

Heat-Resistant Super Alloys (S)

Depending on one's definition of 'heat' and 'resistance' the term heat-resistant super alloys (HRSA) can refer to anything from 316 austenitic stainless steel to near-alpha titanium alloy Ti-6242. For the purposes of this guide, however, heat-resistant super alloys will specifically denote alloys with a nickel or cobalt matrix. Recent developments in stainless steel (duplex and super-austenitic stainless steel) produced alloys that offer a high resistance to corrosion at moderate temperatures with a significantly lower material cost than Ni-based alloys that were used for the same purpose. Corrosion-resistant Ni-based alloys are now almost exclusively used in environments that are not only corrosive but also require strength at elevated temperatures.

The reason why nickel and cobalt are so prized in high-temperature environments is that their melting point is relatively high, and unlike iron (which transforms from ferrite to austenite long before it starts to melt), they retain the same microstructure all the way until melting. With the addition of chromium, Ni- and Co-based alloys also exhibit remarkable resistance to corrosion at high temperatures. Finally, multiple mechanisms can be put in place through alloying and heat treatments to strengthen the nickel and cobalt base and stabilize the microstructure to prevent or slow down degradation at higher temperatures.

Corrosion-Resistant HRSA (S1)

Industry segments:

Oil and gas, petrochemical, pulp and paper, marine and offshore environments, pharma, hydraulics

Common S1 alloys:

Inconel 6XX series, Incoloy, Hastelloy, Monel

Recommended grades and edge preparations:

		Material Deposition Scale	Roughing	Medium-Roughing	Semi-Finishing	Finishing	Coolant
	Continuous Cuts	XSYTIN [®] -1 A / T1A	WG-300 [®] T1	WG-600 [®] T1	WG-600 [®] T1	WG-600 [®] A GF-1	YES
		WG-300 [®] T1A	XSYTIN [®] -1 A	WG-300 [®] T1	WG-300 [®] T1	WG-300 [®] A GF-1	
	Thin-Walled Turning	XSYTIN [®] -1 A	XSYTIN [®] -1 A	XSYTIN [®] -1 A	WG-300 [®] T1	WG-600 [®] A GF-1	YES
		WG-300 [®] T1A	WG-300 [®] T1	WG-300 [®] T1	WG-600 [®] T1	WG-300 [®] A GF-1	
Interrupted Cuts	Light Interruption	XSYTIN [®] -1 A	XSYTIN [®] -1 A	WG-600 [®] T1	WG-600 [®] T1	WG-600 [®] A GF-1	YES
		WG-300 [®] T1A	WG-300 [®] T1	WG-300 [®] T1	WG-300 [®] T1	WG-300 [®] A GF-1	
	Medium Interruption	XSYTIN [®] -1 A / T1	XSYTIN [®] -1 A / T1	XSYTIN [®] -1 A / T1	WG-700 [™] T1A	WG-600 [®] A GF-1	NO
		WG-300 [®] T1A	WG-300 [®] T1A	WG-300 [®] T1A	WG-300 [®] T1A	WG-300 [®] A GF-1	
	Severe Interruption or Milling	XSYTIN [®] -1 A / T1A	XSYTIN [®] -1 A / T1A	XSYTIN [®] -1 A / T1A	XSYTIN [®] -1 A / T1A	-	NO
		WG-300 [®] T1A	WG-300 [®] T1A	WG-300 [®] T1A	WG-300 [®] T1A	-	

High-Strength HRSA (S2)

Industry segments:

Turbo- and super-chargers for reciprocating engines, high-performance reciprocating engines, gas turbines for propulsion or power generation, rocket engines, and ramjets

Common S2 alloys:

Inconel 7XX series, Waspaloy, Rene, Mar-M, Nimonic, IN100, Udimet, RR1000, GTD 111, Haynes

Recommended grades and edge preparations:

		Forging Scale	Roughing	Medium-Roughing	Semi-Finishing	Finishing	Coolant
	Continuous Cuts	XSYTIN®-1 A / T1A	XSYTIN®-1 A	WG-600° T1	WG-600° T1	WG-600° A GF-1	YES
		WG-700™ T1A	WG-300° T1	WG-300° T1	WG-300° T1	WG-300° A GF-1	
	Thin-Walled Turning	XSYTIN®-1 A	XSYTIN®-1 A	WG-700™ T1	WG-700™ T1	WG-600° A GF-1	YES
		WG-300° T1A	WG-700™ T1	XSYTIN®-1 A	XSYTIN®-1 A	WG-300° A GF-1	
Interrupted Cuts	Light Interruption	XSYTIN®-1 A	XSYTIN®-1 A	WG-600° T1	WG-600° T1	WG-600° A GF-1	YES
		WG-300° T1A	WG-300° T1	WG-300° T1	WG-300° T1	WG-300° A GF-1	
	Medium Interruption	XSYTIN®-1 A / T1	XSYTIN®-1 A / T1	XSYTIN®-1 A / T1	WG-700™ T1A	WG-600° A GF-1	NO
		WG-700™ T1A	WG-700™ T1A	WG-700™ T1A	XSYTIN®-1 A	WG-300° A GF-1	
Severe Interruption or Milling	XSYTIN®-1 A / T1A	XSYTIN®-1 A / T1A	XSYTIN®-1 A / T1A	XSYTIN®-1 A / T1A	-	NO	
	WG-700™ T1A	WG-700™ T1A	WG-700™ T1A	WG-700™ T1A	-		

Wear-Resistant HRSA (S3)

Industry segments:

Oil & gas, power generation, petrochemical, hydraulics, material processing

Common S3 alloys:

Stellite, Eutalloy, Metco, Wall Colmonoy, Wearth, Triballoy

Recommended grades and edge preparations for materials with a hardness below 50 HRc:

		Material Deposition Scale	Roughing	Medium-Roughing	Semi-Finishing	Finishing	Coolant
	Continuous Cuts	XSYTIN®-1 A / T1A	XSYTIN®-1 A	WG-600° T1	WG-600° T1	WG-600° A GF-1	YES
		WG-300° T1A	WG-300° T1	WG-300° T1	WG-300° T1	WG-300° A GF-1	
	Thin-Walled Turning	XSYTIN®-1 A	XSYTIN®-1 A	WG-300° T1	WG-300° T1	WG-600° A GF-1	YES
		WG-300° T1A	WG-300° T1	XSYTIN®-1 A	XSYTIN®-1 A	WG-300° A GF-1	
Interrupted Cuts	Light Interruption	XSYTIN®-1 A	XSYTIN®-1 A	WG-600° T1	WG-600° T1	WG-600° A GF-1	YES
		WG-300° T1A	WG-300° T1	WG-300° T1	WG-300° T1	WG-300° A GF-1	
	Medium Interruption	XSYTIN®-1 A / T1	XSYTIN®-1 A / T1	XSYTIN®-1 A / T1	WG-300° T1A	WG-600° A GF-1	NO
		WG-300° T1A	WG-300° T1A	WG-300° T1A	XSYTIN®-1 A	WG-300° A GF-1	
Severe Interruption or Milling	XSYTIN®-1 A / T1A	XSYTIN®-1 A / T1A	XSYTIN®-1 A / T1A	XSYTIN®-1 A / T1A	-	NO	
	WG-300° T1A	WG-300° T1A	WG-300° T1A	WG-300° T1A	-		

Recommended grades and edge preparations for materials with a hardness of 50 HRc or higher:

		Material Deposition Scale	Roughing	Medium-Roughing	Semi-Finishing	Finishing	Coolant
	Continuous Cuts	WG-300° T1A	WG-300° T1A	WG-600° T1A	WG-600° T1A	WG-600° A	YES
		WG-600° T1A	WG-600° T1A	WG-300° T1A	WG-300° T1A	WG-300° A	
	Thin-Walled Turning	WG-300° T1A	WG-300° T1A	WG-600° T1A	WG-600° T1A	WG-600° A GF-1	YES
		WG-600° T1A	WG-600° T1A	WG-300° T1A	WG-300° T1A	WG-300° A GF-1	
Interrupted Cuts	Light Interruption	WG-300° T1A	WG-300° T1A	WG-600° T1A	WG-600° T1A	WG-600° A	YES
		WG-600° T1A	WG-600° T1A	WG-300° T1A	WG-300° T1A	WG-300° A	
	Medium Interruption	XSYTIN®-1 T1A	XSYTIN®-1 T1A	WG-300° T1A	WG-600° T1A	WG-600° T1A	NO
		WG-300° T1A	WG-300° T1A	WG-600° T1A	WG-300° T1A	WG-300° T1A	
Severe Interruption or Milling	XSYTIN®-1 A / T1A	XSYTIN®-1 A / T1A	XSYTIN®-1 A / T1A	XSYTIN®-1 A / T1A	-	NO	
	WG-300° T1A	WG-300° T1A	WG-300° T1A	WG-300° T1A	-		

Hardened Steel (H)

When referring to a material as 'hardened steel' this guide will address iron-based alloys that are hardened through quenching and machined at 40 HRc or higher. It is worth noting that there are essentially two kinds of hardened steel: one where there's enough carbon to create the microstructure, and low-carbon steels where nickel or other elements are used instead. The higher the carbon content – the more internal strain is produced and the higher the attainable hardness through quenching. High-

carbon hardened steels are rather brittle, with favorable chip formation. Low-carbon hardened steels are more ductile and require a different approach because the chip doesn't shear as easily. A class of materials known as TRIP (transformation-induced plasticity as in, for example, Mangalloy) steels where the hardening occurs in service as a result of mechanical stress will not be addressed in this guide, though their applications in earth-moving and high-impact environments are numerous and ceramics are exceptionally well-suited for their machining.

Carbon and Alloyed Hardened Steel (H1)

Industry segments:

General engineering, automotive, tools

Common H1 alloys:

All 4-digit AISI-SAE grades

Recommended grades and edge preparations for materials with a hardness of 40-49 HRc:

		Forging / Material Deposition Scale	Roughing	Finishing	Coolant
	Continuous Cuts	WG-300° T1A	WG-600° T1A	WG-600° T1A	YES
		GEM-8™ T1A	GEM-8™ T1A	GEM-8™ T1A	
	Thin-Walled Turning	XSYTIN®-1 A	WG-300° T1A	WG-600° T1A	YES
		WG-300° T1A	XSYTIN®-1 A	WG-300° T1A	
Interrupted Cuts	Light Interruption	XSYTIN®-1 A	XSYTIN®-1 A	WG-600° T1A	YES
		WG-300° T1A	WG-300° T1A	WG-300° T1A	
	Medium Interruption	XSYTIN®-1 A	XSYTIN®-1 A	WG-600° T1A	NO
		WG-300° T1A	WG-300° T1A	WG-300° T1A	
	Severe Interruption or Milling	XSYTIN®-1 A	XSYTIN®-1 A	WG-600° T1A	NO
		WG-300° T1A	WG-300° T1A	WG-300° T1A	

Recommended grades and edge preparations for materials with a hardness of 50-59 HRc:

		Forging / Material Deposition Scale	Roughing	Finishing	Coolant
	Continuous Cuts	WG-30°0 T1A	WG-600° T1A	WG-600° T1A	NO
		GEM-8™ T2A	GEM-8™ T2A	GEM-8™ T2A	
	Thin-Walled Turning	WG-300° T1A	WG-600° T1A	WG-600° T1A	NO
		WG-600° T1A	WG-300° T1A	WG-300° T1A	
Interrupted Cuts	Light Interruption	WG-300° T1A	WG-300° T1A	WG-600° T1A	NO
		XSYTIN®-1 T1A	XSYTIN®-1 T1A	WG-300° T1A	
	Medium Interruption	XSYTIN®-1 T1A	XSYTIN®-1 T1A	WG-600° T1A	NO
		WG-300° T1A	WG-300° T1A	WG-300° T1A	
	Severe Interruption or Milling	XSYTIN®-1 T1A	XSYTIN®-1 T1A	WG-600° T1A	NO
		WG-300° T2A	WG-300° T2A	WG-300° T1A	

Carbon and Alloyed Hardened Steel (H1) (Continued)

Recommended grades and edge preparations for materials with a hardness of 60 HRC or higher:

		Forging / Material Deposition Scale	Roughing	Finishing	Coolant
	Continuous Cuts	WG-300° T4B+	WG-600° T4B	WG-600° T1A	NO
		GEM-8™ T4B+	GEM-8™ T4B	GEM-8™ T2A	
	Thin-Walled Turning	WG-300° T4B+	WG-600° T4B	WG-600° T1A	NO
		WG-600° T4B+	WG-300° T4B	WG-300° T1A	
Interrupted Cuts	Light Interruption	WG-300° T4B+	WG-600° T4B	WG-600° T1A	NO
		WG-600° T4B+	WG-300° T4B	WG-300° T1A	
	Medium Interruption	WG-300° T4B+	WG-600° T4B	WG-600° T1A	NO
		WG-600° T4B+	WG-300° T4B	WG-300° T1A	
	Severe Interruption or Milling	XSYTIN®-1 T2A	XSYTIN®-1 T2A	WG-600° T1A	NO
		WG-300° T2A	WG-300° T2A	WG-300° T1A	

NOTE: T4B+ denotes the following edge preparations: T4B, T5B, T6B, T10B.

Maraging Steel (H2)

Industry segments:

Turbine engine shafts, drive shafts, crankshafts, gears, aircraft landing gear, ordnance

Common H2 alloys:

Maraging, AerMet, ML340, Super CMV, F1E, ES-1

Recommended grades and edge preparations:

		Forging Scale	Roughing	Finishing	Coolant
	Continuous Cuts	XSYTIN®-1 A	XSYTIN®-1 A	XSYTIN®-1 A	YES
	Thin-Walled Turning	XSYTIN®-1 A	XSYTIN®-1 A	XSYTIN®-1 A	YES
Interrupted Cuts	Light Interruption	XSYTIN®-1 A	XSYTIN®-1 A	XSYTIN®-1 A	YES
	Medium Interruption	XSYTIN®-1 A / T1A	XSYTIN®-1 A	XSYTIN®-1 A	NO
	Severe Interruption or Milling	XSYTIN®-1 A / T1A	XSYTIN®-1 A	XSYTIN®-1 A	NO

Tool Steel (H3)

Industry segments:

Material processing, wear-resistant applications (die and mold in particular)

Common H3 alloys:

W, O, A, D, S, T, M, H, P, L, F AISI-SAE tool steel grades such as: D2, S7, A2

Recommended grades and edge preparations for materials with a hardness of 40-49 HRC:

		Forging / Material Deposition Scale	Roughing	Finishing	Coolant
	Continuous Cuts	WG-300 [®] T1A	WG-600 [®] T1A	WG-600 [®] T1A	YES
		GEM-8 [™] T1A	GEM-8 [™] T1A	GEM-8 [™] T1A	
	Thin-Walled Turning	XSYTIN [®] -1 A	WG-300 [®] T1A	WG-600 [®] T1A	YES
		WG-300 [®] T1A	XSYTIN [®] -1 A	WG-300 [®] T1A	
Interrupted Cuts	Light Interruption	XSYTIN [®] -1 A	XSYTIN [®] -1 A	WG-600 [®] T1A	YES
		WG-300 [®] T1A	WG-300 [®] T1A	WG-300 [®] T1A	
	Medium Interruption	XSYTIN [®] -1 A	XSYTIN [®] -1 A	WG-600 [®] T1A	NO
		WG-300 [®] T1A	WG-300 [®] T1A	WG-300 [®] T1A	
	Severe Interruption or Milling	XSYTIN [®] -1 A	XSYTIN [®] -1 A	WG-600 [®] T1A	NO
		WG-300 [®] T1A	WG-300 [®] T1A	WG-300 [®] T1A	

Recommended grades and edge preparations for materials with a hardness of 50-59 HRC:

		Forging / Material Deposition Scale	Roughing	Finishing	Coolant
	Continuous Cuts	WG-300 [®] T1A	WG-600 [®] T1A	WG-600 [®] T1A	NO
		GEM-8 [™] T2A	GEM-8 [™] T2A	GEM-8 [™] T2A	
	Thin-Walled Turning	WG-300 [®] T1A	WG-600 [®] T1A	WG-600 [®] T1A	NO
		WG-600 [®] T1A	WG-300 [®] T1A	WG-300 [®] T1A	
Interrupted Cuts	Light Interruption	WG-300 [®] T1A	WG-300 [®] T1A	WG-600 [®] T1A	NO
		XSYTIN [®] -1 T1A	XSYTIN [®] -1 T1A	WG-300 [®] T1A	
	Medium Interruption	XSYTIN [®] -1 T1A	XSYTIN [®] -1 T1A	WG-600 [®] T1A	NO
		WG-300 [®] T1A	WG-300 [®] T1A	WG-300 [®] T1A	
	Severe Interruption or Milling	XSYTIN [®] -1 T1A	XSYTIN [®] -1 T1A	WG-600 [®] T1A	NO
		WG-300 [®] T2A	WG-300 [®] T2A	WG-300 [®] T1A	

Recommended grades and edge preparations for materials with a hardness of 60 HRC or higher:

		Forging / Material Deposition Scale	Roughing	Finishing	Coolant
	Continuous Cuts	WG-300 [®] T4B+	WG-600 [®] T4B	WG-600 [®] T1A	NO
		GEM-8 [™] T4B+	GEM-8 [™] T4B	GEM-8 [™] T2A	
	Thin-Walled Turning	WG-300 [®] T4B+	WG-600 [®] T4B	WG-600 [®] T1A	NO
		WG-600 [®] T4B+	WG-300 [®] T4B	WG-300 [®] T1A	
Interrupted Cuts	Light Interruption	WG-300 [®] T4B+	WG-600 [®] T4B	WG-600 [®] T1A	NO
		WG-600 [®] T4B+	WG-300 [®] T4B	WG-300 [®] T1A	
	Medium Interruption	WG-300 [®] T4B+	WG-600 [®] T4B	WG-600 [®] T1A	NO
		WG-600 [®] T4B+	WG-300 [®] T4B	WG-300 [®] T1A	
	Severe Interruption or Milling	XSYTIN [®] -1 T2A	XSYTIN [®] -1 T2A	WG-600 [®] T1A	NO
		WG-300 [®] T2A	WG-300 [®] T2A	WG-300 [®] T1A	

Note: Roughing is for DOC greater than 0.04" (1mm)

Nitrided and/or Carburized Steel (H4)

Industry segments:

Bearings, hydraulics, wear-resistant applications

Common H4 alloys:

32CrMoV13, M50, M50NiL, M2, Pyrowear 675, Nitralloy

Recommended grades and edge preparations:

		White Layer	Roughing	Finishing	Coolant
	Continuous Cuts	GEM-8™ T4B+	GEM-8™ T4B+	GEM-8™ T7A	NO
		WG-300° T4B+	WG-300° T4B	WG-300° T7A	
	Thin-Walled Turning	GEM-8™ T4B+	GEM-8™ T4B+	GEM-8™ T7A	NO
		WG-300° T4B+	WG-300° T4B	WG-300° T7A	
Interrupted Cuts	Light Interruption	GEM-8™ T4B+	GEM-8™ T4B+	GEM-8™ T7A	NO
		WG-300° T4B+	WG-300° T4B	WG-300° T7A	
	Medium Interruption	WG-300° T4B+	WG-300° T4B	WG-300° T7A	NO
		GEM-8™ T4B+	GEM-8™ T4B+	GEM-8™ T7A	
	Severe Interruption or Milling	XSYTIN®-1 T2A	XSYTIN®-1 T2A	WG-600° T1A	NO
		WG-300° T2A	WG-300° T2A	WG-300° T1A	

Cast Iron (K)

Cast iron is an alloy of iron and >2% carbon where carbon forms graphite (because of the addition of silicon) or cementite (Fe₃C). Because of the inability of graphite to carry stresses or the high fraction of brittle phases most cast iron is quite brittle. The quantity of carbon that remains as graphite and relative fraction of phases

ultimately affect hardness, strength, and the behavior of the material. This guide will not address the machining of malleable cast irons (EN-GJMB, EN-GJMW), austenitic nodular cast irons (EN-GJSA, Ni-resist), or cast irons specific to the roll industry, though all of them lend themselves exceptionally well to ceramic machining.

Gray (Lamellar) Cast Iron (K1)

Industry segments:

Automotive, general engineering, housings, machine tools

Common K1 alloys:

GG15 – GG35 a.k.a. EN-GJL-150 – EN-GJL-350
(for 150-350 MPa minimum tensile strength)

Recommended grades and edge preparations:

		Roughing	Finishing	Coolant
Interrupted Cuts	Continuous Cuts	GSN100™ T2	GSN100™ T2	POSSIBLE
		XSYTIN®-1 T2	WG-600° T2	
	Light-Medium Interruption	GSN100™ T2	GSN100™ T2	NO
		XSYTIN®-1 T2	WG-600° T2	
	Severe Interruption or Milling	GSN100™ T2A	GSN100™ T2	NO
		XSYTIN®-1 T2A	WG-600° T2	

Ductile (Nodular) Cast Iron (K2)

Industry segments:

Pipe, automotive, wind energy, machine tools, metal processing

Common K2 alloys:

GGG40 – GGG80 a.k.a. EN-GJS-400 – EN-GJS-800
(for 400-800 MPa minimum tensile strength)

Recommended grades and edge preparations:

		Roughing	Finishing	Coolant
Interrupted Cuts	Continuous Cuts	GSN100™ T2	GSN100™ T2	POSSIBLE
		XSYTIN®-1 T2	WG-600° T2	
	Light-Medium Interruption	GSN100™ T2	GSN100™ T2	NO
		XSYTIN®-1 T2	WG-600° T2	
	Severe Interruption or Milling	GSN100™ T2A	GSN100™ T2	NO
		XSYTIN®-1 T2A	WG-600° T2	

Compacted Graphite (Vermicular) Cast Iron (K3)

Industry segments:

Automotive, high-compression (and high-displacement) diesel engines, turbochargers

Common K3 alloys:

CGI, EN-GJV-300 – EN-GJV-500 (for 300-500 MPa minimum tensile strength)

Recommended grades and edge preparations:

		Roughing	Finishing	Coolant
Interrupted Cuts	Continuous Cuts	XSYTIN®-1 A / T2	XSYTIN®-1 A / T2	POSSIBLE
		GSN100™ T2	GSN100™ T2	
	Light-Medium Interruption	XSYTIN®-1 A / T2	XSYTIN®-1 A / T2	NO
		GSN100™ T2	GSN100™ T2	
	Severe Interruption or Milling	XSYTIN®-1 A / T2A	XSYTIN®-1 A	NO
		GSN100™ T2A	GSN100™ T2A	

White Cast Iron (K4)

Industry segments:

Grinding and ore crushing equipment, rolls, pumps, extrusion, and various applications requiring high resistance to abrasion and high hot-hardness

Common K4 alloys:

Ni-Hard, EN-GJN-HV350 – EN-GJN-HV600 (for 350-600 minimum HV hardness)

Recommended grades and edge preparations:

		Roughing	Finishing	Coolant
Interrupted Cuts	Continuous Cuts	GEM-8™ T10B	WG-600° T4B+	NO
		WG-300° T4B+	GEM-8™ T10B	
	Light-Medium Interruption	WG-300° T4B+	WG-600° T4B+	NO
		XSYTIN®-1 T2A+	WG-300° T4B+	
	Severe Interruption or Milling	XSYTIN®-1 T2A+	WG-600° T1A	NO
		WG-300° T2A+	WG-300° T1A	

Austempered Ductile Iron (K5)

Industry segments:

Structural applications requiring lower overall weight than the equivalent in structural steel: construction, mining, agriculture, automotive, railroad, etc.

Common K5 alloys:

ADI, EN-GJS-800 – EN-GJS-1400 (for 800-1400 MPa minimum tensile strength)

Recommended grades and edge preparations:

		Roughing	Finishing	Coolant
Interrupted Cuts	Continuous Cuts	GSN100™ T2	GSN100™ T2	POSSIBLE
		XSYTIN®-1 T2	WG-600° T2	
	Light-Medium Interruption	GSN100™ T2	GSN100™ T2	NO
		XSYTIN®-1 T2	WG-600° T2	
	Severe Interruption or Milling	GSN100™ T2A	GSN100™ T2	NO
		XSYTIN®-1 T2A	WG-600° T2	

Nitrided and/or Carburized Cast Iron (K6)

Industry segments:

High-compression, high-displacement diesel engines, wear-resistant applications not requiring tensile strength

Common K6 alloys:

K1, K2

Recommended grades and edge preparations:

		White Layer	Roughing	Finishing	Coolant
	Continuous Cuts	GEM-8™ T4B+	GEM-8™ T4B+	GEM-8™ T7A	NO
		WG-300® T4B+	WG-300® T4B	WG-300® T7A	
	Thin-Walled Turning	GEM-8™ T4B+	GEM-8™ T4B+	GEM-8™ T7A	NO
		WG-300® T4B+	WG-300® T4B	WG-300® T7A	
Interrupted Cuts	Light Interruption	GEM-8™ T4B+	GEM-8™ T4B+	GEM-8™ T7A	NO
		WG-300® T4B+	WG-300® T4B	WG-300® T7A	
	Medium Interruption	WG-300® T4B+	WG-300® T4B	WG-300® T7A	NO
		GEM-8™ T4B+	GEM-8™ T4B+	GEM-8™ T7A	
	Severe Interruption or Milling	XSYTIN®-1 T2A	XSYTIN®-1 T2A	WG-600® T1A	NO
		WG-300® T2A	WG-300® T2A	WG-300® T1A	

Stainless Steel (M)

Steel containing more than ~11% chrome where the chrome is available to form a passivating layer of oxides on the surface that prevents any layers below from being affected and reforms almost instantly if any part of it is removed is known as stainless for its resistance to corrosion. Stainless steels can be ferritic, austenitic, martensitic, or some mixture thereof. Higher alloying content is associated with higher resistance

to different corrosive media, while martensite and precipitates are associated with higher hardness and strength. With the exception of high-carbon martensitic stainless steel, M class alloys are low-carbon and as such are tough and ductile. The majority of machined stainless steels are not ferritic, which is why this guide will not address ferritic stainless steels.

Austenitic Stainless Steel (M1)

Industry segments:

Petrochemical, oil & gas, power generation, medical, pulp and paper, structural elements

Common M1 alloys:

300 and 200 AISI/ASTM series, with 304 and 316 being the most common of all

Recommended grades and edge preparations:

		Roughing	Coolant
Interrupted Cuts	Continuous Cuts	WG-600° T1A	YES
		WG-300° T1A	
	Light-Medium Interruption	WG-600° T1A	YES
		WG-300° T1A	
	Severe Interruption or Milling	WG-600° T1A	NO
		WG-300° T1A	

Martensitic Stainless Steel (M2)

Industry segments:

Aerospace, power generation, medical, gears, valves, shafts, offshore oil & gas, bearings

Common M2 alloys:

416 (1.4005), 410 (1.4006), 420 (1.4021), 431 (1.4057), 248SV (1.4418), CA6NM (1.4313), Jethete M152 (1.4938)

Recommended grades and edge preparations:

		Forging / Material Deposition Scale	Roughing	Finishing	Coolant
Interrupted Cuts	Continuous Cuts	WG-300° T1A	WG-600° T1A	WG-600° T1A	YES
		WG-600° T1A	WG-300° T1A	WG-300° T1A	
	Light-Medium Interruption	WG-300° T1A	WG-600° T1A	WG-600° T1A	YES
		WG-600° T1A	WG-300° T1A	WG-300° T1A	
	Severe Interruption or Milling	WG-300° T1A	WG-600° T1A	-	NO
		WG-600° T1A	WG-300° T1A	-	

Super-Austenitic Stainless Steel (M3)

Industry segments:

Pulp & paper, petrochemical, water treatment, pollution control, offshore oil & gas, power generation

Common M3 alloys:

S31266 (1.4659), 904L (1.4539), N08031 (1.4562), S34565 (1.4565), N08926 (1.4529), S31254 (1.4547), N0828 (1.4563), S32654 (1.4652), 1.4588

Recommended grades and edge preparations:

		Roughing	Coolant
Interrupted Cuts	Continuous Cuts	WG-600° T1A	YES
		WG-300° T1A	
	Light-Medium Interruption	WG-600° T1A	YES
		WG-300° T1A	
	Severe Interruption or Milling	WG-600° T1A	NO
		WG-300° T1A	

Duplex Stainless Steel (M4)

Industry segments:

Petrochemical, oil & gas, power generation, pharmaceutical, geothermal, desalination, biomass, mining

Common M4 alloys:

F51 (1.4462), F53 (1.4410), F55 (1.4501), 255 (1.4507), 1.4162, 1.4362, CD3MN

Recommended grades and edge preparations:

		Roughing	Coolant
Interrupted Cuts	Continuous Cuts	WG-600° T1A	YES
		WG-300° T1A	
	Light-Medium Interruption	WG-600° T1A	YES
		WG-300° T1A	
	Severe Interruption or Milling	WG-600° T1A	NO
		WG-300° T1A	

Precipitation-Hardening Stainless Steel (M5)

Industry segments:

Aerospace, power generation, petrochemical, oil & gas

Common M5 alloys:

A286, PH14-8Mo, PH15-7Mo, 17-7PH, PH13-8Mo, 15-5PH, 15-7PH, 17-4PH

Recommended grades and edge preparations:

		Roughing	Coolant
Interrupted Cuts	Continuous Cuts	WG-600° T1A	YES
		WG-300° T1A	
	Light-Medium Interruption	WG-600° T1A	YES
		WG-300° T1A	
	Severe Interruption or Milling	WG-600° T1A	NO
		WG-300° T1A	

Chip Formation

Broadly speaking, ceramic machining differs from carbide machining in the strain rates that the machined materials are subjected to. The strain rates are significantly higher because of the speeds at which ceramics are applied, the significantly more negative rake angles, and absence of chipforms in roughing, all of which the ceramic cutting tool materials are able to withstand because of their high-temperature strength and hardness.

Machining processes produce high strain rates in ductile materials, and the goal in general is to:

1. Make use of the compressive strain in the primary shear zone to plasticize the machined layer of material ahead of the cut, reducing specific cutting energy. Then force the chip through a great degree of deformation quickly, embrittling it and making it easier to break
2. Direct chip flow with geometric features of the tool to minimize strain rates at and ahead of the cutting edge (so minimize heat generation) but force the chip to curl and break on impact

Chip Thickness

Chip thickness is a parameter that is particularly important in ceramic machining because of its role in the distribution of heat and the importance of heat in a ceramic machining operation. In turning, chip thickness is a function of feed and lead angle, where a round insert's lead angle varies with depth of cut, while in milling it is also affected by the engagement (stepover).

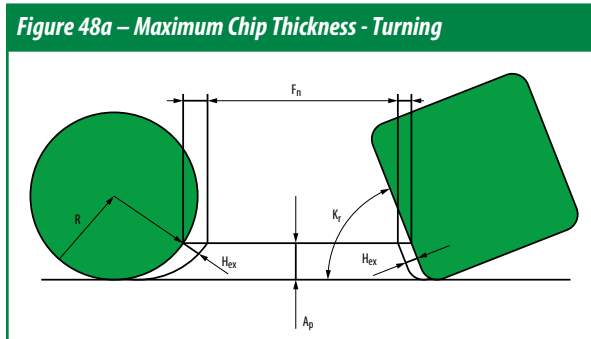

For straight-edged inserts in turning:

$$H_{ex} = F_n \sin(K_r)$$

For round inserts in turning:

$$H_{ex} \approx F_n \sin(\cos^{-1}(1 - A_p/R))$$

The majority of the heat generated in ceramic machining is a result of the strain that the deformed surface layer of the workpiece experiences, so it comes as no surprise that the majority of the heat is also evacuated as the deformed surface layer separates and becomes the chip. The capacity of the chip to carry heat, however, is limited by its thickness – the thinner the chip the less heat it is able to carry out of the cutting area. It is possible, then, to control the distribution of heat to some degree by adjusting the chip thickness.

It is a common misconception that ceramic machining can only be carried out at a single 'optimal speed.' Reducing the cutting speed lowers strain rates, reducing the extent to which the chip is embrittled and the heat that is generated, increasing the

With strain rates that WC-Co tools are able to produce (the primary limitation being hot-hardness: the higher the strain rate the more heat is produced, which greatly diminishes the strength and hardness of WC-Co) option 1 is not viable. Option 2 is then the primary method, which is why chipforms play such a pivotal role in carbide machining.

With the much higher temperatures that Greenleaf ceramics are able to sustain, option 1 is the primary method of chip formation and breaking in all ductile materials.

Because hardness and strength are most often positively correlated, it also follows that the strain rates required for the same type of chip formation are lower for harder materials and vice versa. So, Waspaloy heat treated to 34 HRC will contain a lower fraction of fine precipitates (and/or have higher average grain size) than Waspaloy heat treated to 42 HRC, and the strain rates required to produce a favorably sheared chip in 34 HRC Waspaloy are higher, corresponding to higher cutting speeds.

specific cutting energy and requiring higher effort to continue deforming the surface layer to failure. This, in turn, may exceed the strength of the cutting tool, leading to irregular wear or fracture. So, to compensate for the higher material strength one must reduce the mechanical loads by reducing the cross-sectional area of the chip. And reducing the chip thickness (as opposed to chip cross-sectional area, which would imply the ability to control heat evacuation the same effect by reducing feed or depth of cut independently) reduces the capacity of the chip to carry heat away, allowing more heat to remain in the cutting zone, plasticizing the workpiece material and locally reducing its strength.

A rule of thumb that holds for all ceramic turning of ductile materials:

Having determined the optimal cutting speed and chip thickness for a given insert in a given material, one can vary speed and chip thickness proportionately up or down as required. Adjusting up is dependent on the limits of the cutting tool, machine, and workpiece.

Note that this relationship is far from exact and cannot be used to reduce the speed indefinitely – there is a minimum speed below which strain rates are too low and the stress required to deform the material to failure is higher than the strength of the ceramic cutting tool, resulting in irregular wear or fracture.

It does, however, mean that having found one combination of speed and chip thickness with RNGN-45 T1 WG-300® in forged Inconel 718 at 45 HRC we are able to apply any other WG-300® negative insert with the T1 edge preparation at the same rake angles in any other part from forged Inconel 718 at 45 HRC.

Suppose that you run a test and find that a solid cylinder of forged Inconel 718 at 45 HRC is best machined with an RNGN-45 T1 WG-300® at $V_c = 1150$ SFM (350m/min) and a chip thickness of $H_{ex} = 0.0063$ " (0.16mm). Suppose then, that instead of machining a solid cylinder you are machining a thin-walled seal in a used VTL – the rigidity of part, fixture, and machine are rather different, and it's likely that the cutting forces required to turn the part at $V_c = 1150$ SFM (350m/min) and $H_{ex} = 0.0063$ " (0.16mm) with a round insert would lead to deflection, vibration, and very poor tool life. So, changing

the tool to a CNGN-452 T1 WG-300® and reducing the speed to 820 SFM (250m/min) would require reducing the chip thickness to $0.0063" \times 820/1150 = 0.0043"$ (0.11mm) which at nearly no lead angle^[2] for a CNGN would translate into 0.0047 IPR (0.12mm/rev) feed and a depth of cut that the insert can sustain without failure – something that should be determined through trial and error.

It also follows that for every combination of material and cutting tool there is an optimal $V_c \times H_{ex}$ pair at the higher end of speeds (so in stable machining environments) that can be adjusted to fit the given application, as above.

These recommendations for continuous cuts are provided in the tables on the following pages.

^[2] The convention in this guide is to measure the lead angle as the angle between the cutting edge and a line drawn perpendicular to the direction of feed. As such, the lead angle of the 80° corner of a CNGN is typically -5°, while the lead angle of a high-feed milling cutter is, for example, 80°.

Note that these are the recommended starting cutting conditions. You may need to adjust both speed and chip thickness up or down to optimize the process for your unique machining environment.

Speed and Chip Thickness Recommendations — Turning

	HRC	Cutting Speed: V_c [SFM]				Cutting Speed: V_c [m/min]			
		Maximum Chip Thickness: H_{ex} [inch]				Maximum Chip Thickness: H_{ex} [mm]			
		GEM-8™	WG-300® WG-600® WG-700™	XSYTIN®-1	GSN100™	GEM-8™	WG-300® WG-600® WG-700™	XSYTIN®-1	GSN100™
S1: Corrosion-Resistant HRSA Inconel 625, Incoloy 825, Hastelloy, Monel		V_c :	1500	800		450	250		
		H_{ex} :	0.0065	0.0095		0.16	0.24		
S2: High-Strength HRSA (Solution-Treated^[3]) Low γ'^[4] S2 (Solution-Treated and Aged) Inconel 706, Inconel 718, Inconel 725 High γ' S2 (Solution-Treated and Aged) IN100, Udimet 720, Waspaloy, C1023, Rene 88, N-18	20	V_c :	1950	1250		600	375		
		H_{ex} :	0.007	0.0105		0.18	0.27		
	40-45	V_c :	1150	800		350	250		
		H_{ex} :	0.0065	0.0095		0.16	0.24		
	40-50	V_c :	650	500		200	150		
		H_{ex} :	0.0045	0.007		0.12	0.18		
S3: Wear-Resistant HRSA Stellite, Eutalloy, Metco, Wall Colmonoy, Weartech	20 ^[5]	V_c :	1950	1250		600	375		
		H_{ex} :	0.007	0.0105		0.18	0.27		
	62	V_c :	250	200		80	55		
		H_{ex} :	0.003	0.0045		0.08	0.12		
H1: Carbon and Alloyed Steel All 4-digit AISI-SAE grades: 1010, 1060, 4140, 2550, 2350, etc.	40	V_c :	1000	1000	700	300	300	210	
		H_{ex} :	0.0045	0.0065	0.0095	0.12	0.16	0.24	
	60	V_c :	500	500	350	150	150	105	
		H_{ex} :	0.002	0.0025	0.0035	0.05	0.06	0.09	
H2: Maraging Steel Maraging 250, AerMet 100, ML340, Super CMV, F1E, ES-1	55	V_c :		600				180	
		H_{ex} :		0.008				0.2	
H3: Tool Steel D2, M4, S7, A2, etc.	45	V_c :	750	750	500	225	225	160	
		H_{ex} :	0.004	0.0045	0.007	0.1	0.12	0.18	
	65	V_c :	250	250	200	80	80	55	
		H_{ex} :	0.0015	0.0015	0.0025	0.04	0.04	0.06	
H4: Nitrided and/or Carburized Steel 32CrMoV13, M50, M50NiL, M2, Pyrowear 675, Nitalloy	64	V_c :	250	250	200	80	80	55	
		H_{ex} :	0.0015	0.0015	0.0025	0.04	0.04	0.06	
K1: Lamellar (Grey) Cast Iron GG15, GG25, GG35 (EN-GJL-150, EN-GJL-250, EN-GJL-350)		V_c :		3600	3600			1100	1100
		H_{ex} :		0.014	0.014			0.35	0.35
K2^[6]: Nodular Cast Iron GGG40 – GGG80 (EN-GJS-400 – EN-GJS-800)		V_c :		2600	2600			800	800
		H_{ex} :		0.01	0.01			0.25	0.25
K3: Compacted Graphite Iron (CGI) EN-GJV-300 – EN-GJV-500		V_c :		1150	1150			350	350
		H_{ex} :		0.01	0.01			0.25	0.25

Table continued on following pages

^[3] Solution Treated condition - most alloying elements are in solid solution, strength and hardness are low

^[4] Solution Treated and Aged condition - secondary phases have been precipitated. γ' : Ni, Ti & Ni₃Al, so alloys with lower Al and Ti content (like Inconel 718) have less γ' and alloys with more Al and Ti (like IN100) have more γ' . The heat treatment (particularly solutioning temperature and aging temperature and time) also affect γ' fraction.

^[5] Where two sets of values are shown for different hardness, extrapolate cutting speed and chip thickness linearly to obtain starting cutting data for the material machined. e.g., turning H1 steel at 50HRC with GEM-8™: $V_c = 750$ SFM (225m/min).

^[6] Cast irons used as rolls in material processing applications vary greatly in composition, microstructure, and machinability. Cutting speeds range from 130 SFM (40m/min) in particularly hard white irons to 650 SFM (200m/min) in alloyed pearlite.

Speed and Chip Thickness Recommendations — Turning (Continued)

	HRC	Cutting Speed: V _c [SFM] Maximum Chip Thickness: H _{ex} [inch]				Cutting Speed: V _c [m/min] Maximum Chip Thickness: H _{ex} [mm]				
		GEM-8™	WG-300® WG-600® WG-700™	XSYTIN®-1	GSN100™	GEM-8™	WG-300® WG-600® WG-700™	XSYTIN®-1	GSN100™	
		V _c	H _{ex}	V _c	H _{ex}	V _c	H _{ex}	V _c	H _{ex}	
K4: White Cast Iron Ni-Hard, EN-GJN-HV350 – EN-GJN-HV600	60	V _c	250	250	200		80	80	55	
		H _{ex}	0.001	0.0015	0.0025		0.03	0.04	0.06	
K5: Austempered Ductile Iron (ADI) EN-GJS-800 – EN-GJS-1400		V _c			1000				300	
		H _{ex}			0.01				0.25	
K6: Nitrided and/or Carburized Cast Iron K1 and K2 are commonly used as the parent material	64	V _c	250	250	200		80	80	55	
		H _{ex}	0.001	0.0015	0.002		0.03	0.04	0.05	
M1: Austenitic Stainless Steel 304, 316, 301, 201, 202, 205, etc.		V _c		1300				400		
		H _{ex}		0.011				0.28		
M2: Martensitic Stainless Steel 416, 410, 420, 431, etc.	50	V _c		500				150		
		H _{ex}		0.0045				0.12		
M3: Super-Austenitic Stainless Steel S31266, 904L, N08031, S34565, 1.4588, etc.		V _c		1000				300		
		H _{ex}		0.0065				0.16		
M4: Duplex Stainless Steel F51 (1.4462), F53 (1.4410), F55 (1.4501), 255 (1.4507), CD3MN		V _c		1300				400		
		H _{ex}		0.011				0.28		
M5: Precipitation-Hardening Stainless Steel A286, PH14-8Mo, PH15-7Mo, 15-5PH, 15-7PH, 17-4PH, 17-7PH	40	V _c		1000				300		
		H _{ex}		0.0065				0.16		

Ceramic Wear Patterns

While there are always multiple wear mechanisms in play, one will typically be dominant and tool-life limiting. The following are the most common dominant modes of wear when machining with ceramics:

1. FLANK: Flank Wear and Edge Rounding

Figure 51a

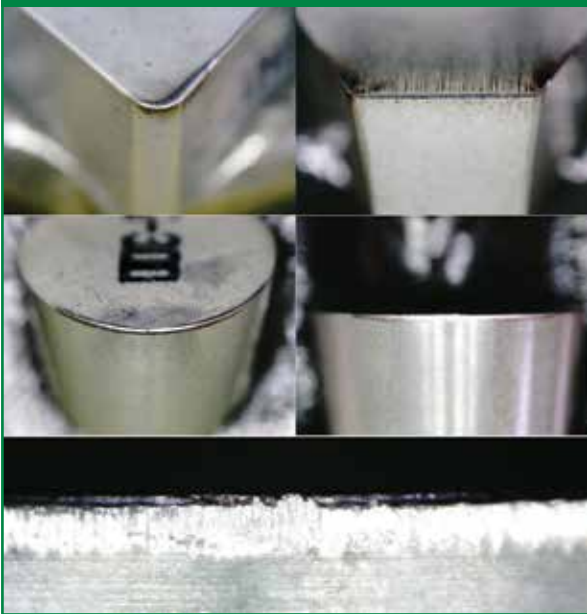

Flank wear and edge rounding is what is referred to as ‘regular wear’ (where all other entries below are jointly described as ‘irregular wear’). It is by far the best kind of wear to have. Simply put, it means that the machining process is stable, stresses are carried well, heat distribution does not result in insufficient plasticization or excessive heat in either tool or workpiece, and the tool is being consumed evenly as material is removed.

2. RAKE: Chipping

Chipping is frequently a result of vibration and instability, or the cutting tool encountering large inclusions along the cutting path that are significantly different (typically harder) from the rest of the material being machined. Chipping leads to

Figure 51b



an uneven distribution of mechanical stresses and heat along the cutting edge and lowers tool life. Prolonged chipping may lead to flaking. To maximize rigidity, use the strongest tool and fixture available, and reduce tool hangout to a minimum. Cutting forces may need to be reduced through insert geometry and cutting conditions. Lower speed generally corresponds to lower likelihood of hitting harmonics, but it may also be enough to introduce variation in RPM (+/-5% for example) to break up any resonance. If chipping is a result of hitting hard particles in the material – use a heavier edge preparation, and potentially lower the cutting speed to reduce thermal softening of the tool and force of impact.

3. RAKE: Flaking

Figure 51c

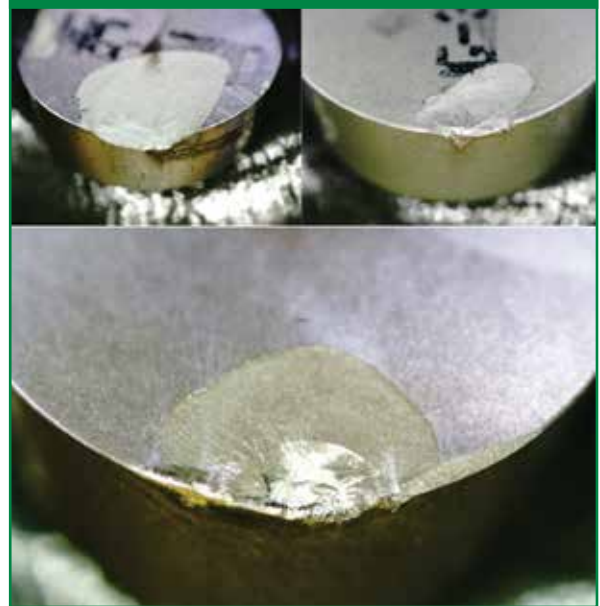

Flaking is a more severe version of chipping and may indicate the speed being too low to reach optimal strain rates and plasticization, or the chip thickness being too high resulting in excessive mechanical stress and too much heat leaving the cutting zone with the chip. Prolonged flaking may lead to top-slicing. Optimize cutting speed first since it is the parameter that is of greatest influence in ceramic machining. Make sure that entry into the material and any changes in the direction of the tool path are as smooth and gradual as possible. If the material has particles of high hardness (more common in roll turning) – increase the edge preparation and use an insert with a stronger shape.

4. RAKE: Top-Slicing

Figure 52a



Top-slicing occurs when the mechanical stresses parallel to the surface of the tool exceed the transverse rupture strength of the cutting tool. This is generally a result of excessive chip thickness combined with speed that is too low or too high. In Al_2O_3 -based ceramics it's more likely that the speed is too low, while in Si_3N_4 -based ceramics it's more likely that the speed is too high. Unexpected top-slicing generally indicates instability. Reevaluate the cutting path to rule out any sudden increases in chip thickness, and reduce cutting conditions, particularly feed rate.

5. FLANK: Flank-Slicing

Figure 52b

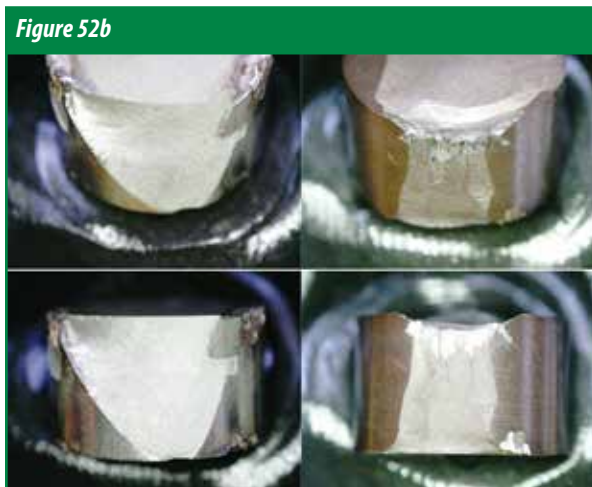

Flank slicing is usually a result of impact that exceeds the toughness and transverse rupture strength of the cutting tool. Flank slicing is also an end-case of existing irregular wear and excessive speed. Use a tougher cutting tool grade (e.g. XSYTIN®-1), lower the cutting speed, and once again make sure that everything about the cutting path is as smooth as can be.

6. RAKE & FLANK: Chemical Wear

Figure 52c

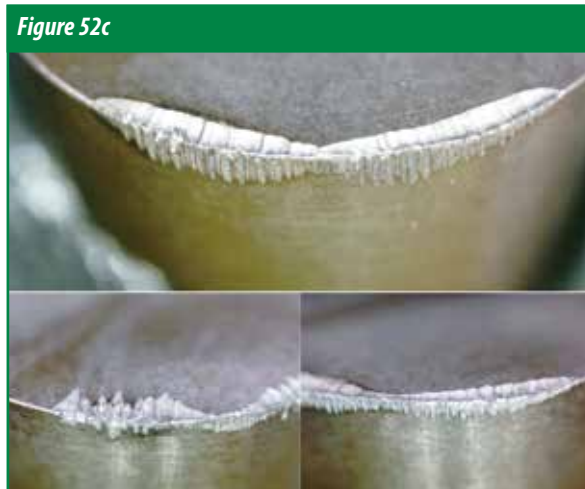

Chemical wear occurs as a result of chemical interaction between the tool and the workpiece at elevated temperatures. It is expressed as crater wear on the rake face and aggressive abrasion and ridges on the flank. Reducing the amount of generated (lower cutting speed) and retained (higher chip thickness) heat is somewhat helpful, but cutting tool and workpiece material incompatibility may ultimately mean that another cutting tool should be used. This mode of wear is the least common, provided the material being machined is addressed in this guide and recommendations for cutting tool selection are followed. Particularly aggressive chemical wear looks like mechanical abrasion.

7. FLANK: Mechanical Abrasion

Figure 52d



In instances where mechanical abrasion is the primary wear mechanism the flank of the insert looks like it's been ground by the workpiece after a short time in the cut. The material being machined is probably more like a composite in microstructure – with significant strength and hardness variation between the main phases, and 1) the hardness of the cutting tool is not sufficiently higher than the microhardness of certain phases of the workpiece material 2) the heat retained in the cutting zone is too high 3) there is aggressive chemical wear. Reduce cutting speed and feed, use a heavier edge prep, or ultimately switch to a grade with higher hot hardness (e.g. GEM-8™). This wear is more common in S3, H4, K4, K6, and M4 material sub-groups.

8. FLANK: Notching**Figure 53a**

Notching is mostly mechanical in nature, with the additional chemical element if the temperature at the surface is sufficiently high to allow the cutting tool to oxidize. Otherwise, it's a special case of mechanical abrasion that occurs when a cutting tool that is less resistant to crack initiation is used to machine a material that exhibits heavy strain-hardening, or when a carbide/oxide-rich scale is present. In either case – the hardness of the surface layer is higher than the hardness of the material deeper in the cut, which leads to higher heat generated in the portion of the cutting zone where this harder layer is being removed, which softens the cutting tool sufficiently to enable heavier abrasive wear. This wear is more common with Al_2O_3 -based ceramics in S and M material groups, or when removing any hard scale. Straight-edged inserts are generally more susceptible to notching than round inserts (because of the higher edge strength of round inserts) though a much stronger determinant is the lead angle – the lower the lead angle the more likely it is that there will be notching. Lower speed and higher lead angles (or lower depth of cut with round inserts) reduce notching. Ceramics with a combination of high fracture toughness and transverse rupture strength (e.g. XSYTIN[®]-1) are inherently more resistant to notching and should be used to their full extent. Having found the optimal cutting speed, try increasing the feed rate to widen the notch and reduce the contact time between the tool and the workpiece.

9. RAKE: Crater Wear**Figure 53b**

Crater wear is more common in XSYTIN[®]-1 and is mostly a combination of chemical wear and mechanical abrasion. Unless the crater wear is very aggressive, which would then make it more likely to be predominantly chemical in nature, it is a reliable and manageable wear pattern. Increasing the feed (and reducing the depth of cut if chip thickness should be preserved with a round insert) would move the crater farther from the edge, not compromising the strength and toughness of the cutting tool. Reducing the speed will also reduce the rate at which the crater forms.

10. RAKE & FLANK: Fracture**Figure 53c**

Fracture, otherwise known as catastrophic failure, is what happens when ceramic tools are grossly misapplied. And even when grossly misapplied, XSYTIN[®]-1 will likely not fracture but will show heavy top-slicing that has a deep notch-like appearance from the flank of the insert.

Figure 53d
XSYTIN[®]-1 Heavy Top-Slicing

Machining Strategy: Continuous and Lightly-Interrupted Cuts

This section of the guide aims to describe how best to apply ceramics in turning to extend tool life. Tool life here is measured in volume of material removed per edge – not minutes. While a WC-Co tool is capable of perhaps 20-30 minutes of tool life in a demanding application, it will remove significantly less material than a well-applied ceramic cutting tool that's been in the cut for 5-10 minutes. The more “difficult” the material machined – the more important it is to adhere to the recommendations put forth in this guide. In order of decreasing “difficulty”, they are roughly as follows:

S2, S3, S1, H2, K5, K3, M4, M5, M3, H4, K6, K4, M1, H3, M2, H1, K2, K1.

WC-Co vs. Ceramics

It is quite important to note that carbide machining is much more forgiving than ceramic machining – carbide will machine most materials with some degree of success. Because of the toughness and strength of carbide, it does not require as much care when applied – speed being too low is rarely a concern, the variation of

mechanical stresses is less detrimental to tool life, inserts with holes are the norm, and positive rake angles can be applied almost indiscriminately of the material being machined.

One cannot apply ceramics in the same fashion as carbide and expect to be successful.

In 99% of all cases changing from carbide to ceramics requires rethinking the entire process. But after all is said and done, the productivity and tool life that ceramics offer are more than worth the efforts that go into the extensive trial and implementation period.

Material-Independent Guidelines

Regardless of the workpiece material and application, ensuring the wear is regular (so is kept to flank wear and edge rounding) is beneficial to the reliability of the process and will result in higher tool life. To that end, one must consider the following when machining with ceramics:

1. Rake angles and clearance
2. Mechanical stresses
3. Heat distribution
4. Cutting tool properties

Rake Angles and Clearance

Under normal tool wear circumstances, a tool is said to be “worn out” when the flank wear has developed to the point that surface finish has deteriorated outside of acceptable limits. This is determined when the width of the wear land has decreased clearance and increased heat and pressures in the tool-workpiece interface area to the point that further use will lead to complete failure of the tool by severe flaking or fracture. Assuming that flank wear is the primary mode of wear, tool life, as judged by wear land development, can be prolonged by increasing the tool side clearance. The same logic applies to increasing rake angles for negative inserts, which is another reason why standard Greenleaf tools for negative ceramic inserts have -10° side rake instead of the -5° - -6° common in toolholders for WC-Co.

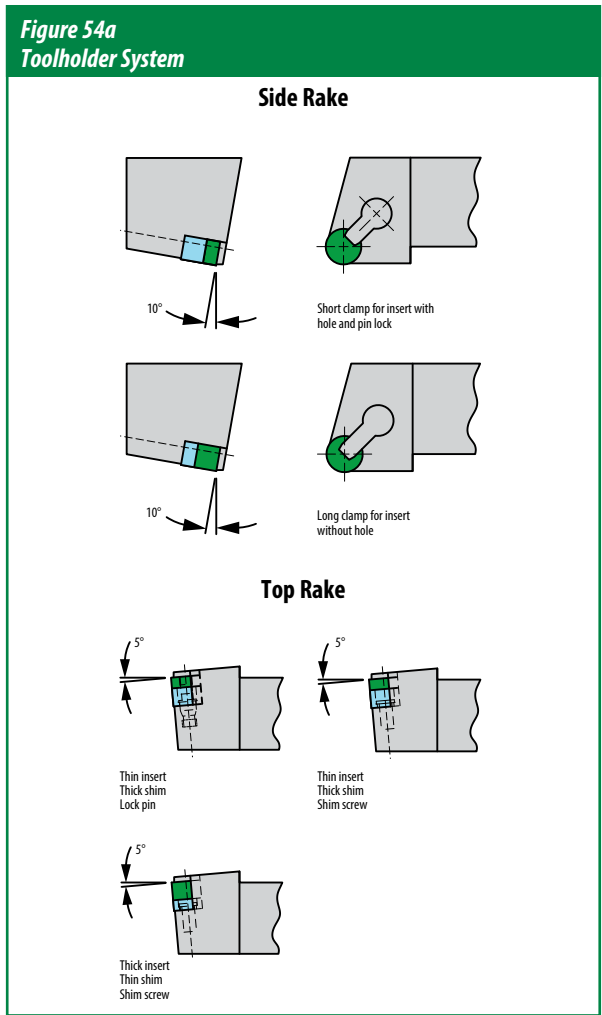

For example, to see the difference that 11° clearance makes compared to 7° clearance, refer to the illustration. (Figure 55a) With a 7° clearance angle, 0.003" (0.07 mm) of material will be worn from the insert to produce a 0.025" (0.64 mm) wear land, whereas 0.005" (0.12 mm) of material must be worn from an 11° clearance insert to produce the same amount of wear land. This will then equate to increased tool life between indexes. It is recommended that tooling be carefully evaluated on all operations relative to using clearance angle inserts. In most cases, investments in new tools can be justified. Standard Greenleaf tools for V-bottom round inserts are designed to take 7° and 11° side clearance inserts.

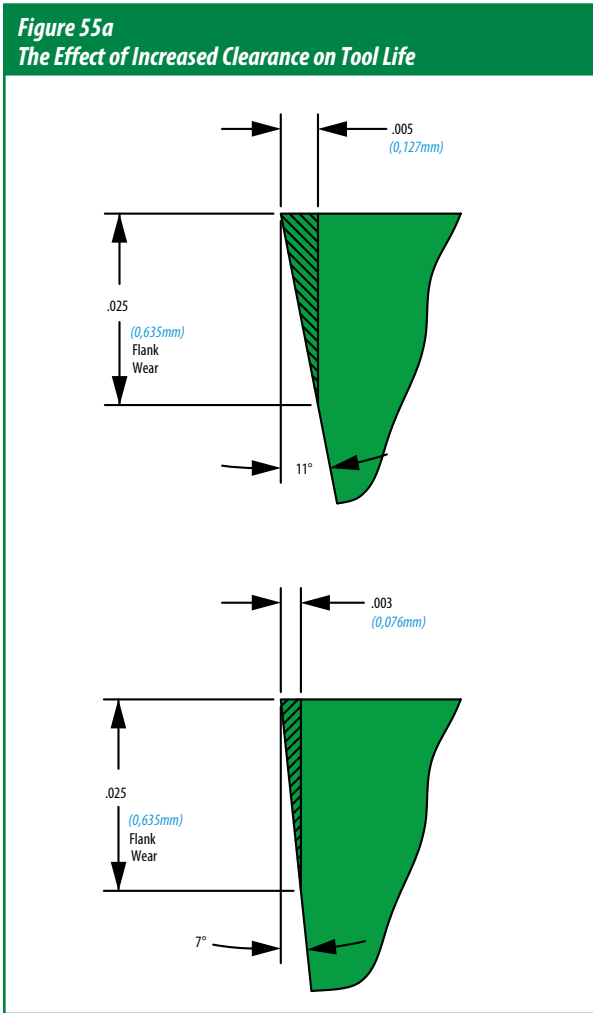

Note that 11° clearance and -10° side rake are only beneficial when wear is regular and the cut is stable. For applications where deflection and vibration are likely because the workpiece material is more difficult to machine and the holder lacks rigidity because of the geometry of the feature machined, 7° clearance will provide higher edge strength and more reliability.

Mechanical Stresses

Reducing variation in cutting forces is perhaps the most important because, with lower tensile strength and brittle fracture being the primary mechanism of failure, ceramics are generally not as resistant to impact as WC-Co. The following are instances in which extra care must be taken to protect the edge from irregular wear by avoiding changes in cutting forces:

1. Entering and exiting the cut

It is highly beneficial to enter the cut on a large radius (rolling in) or at least with a 50% reduction in feed to prevent the sharp edge of the workpiece from damaging the tool while the heat distribution has not reached an equilibrium and plasticization of the workpiece is low. Failure to do so may result in notching (particularly in S materials), chipping, and flaking.

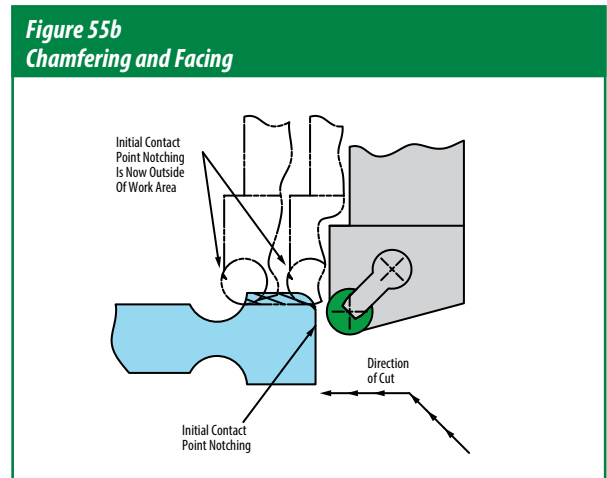

Another approach is to pre-chamfer the entry, eliminating first contact with a sharp edge:

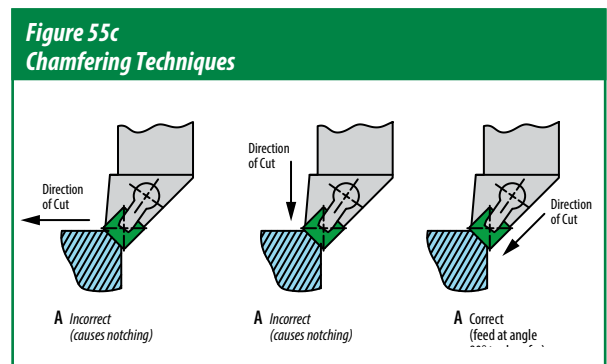

Exiting the part can also be damaging to the tool, because both the workpiece and the tool can spring back after the load of the cutting force is removed. To avoid this, pre-chamfer the exit or reduce the feed to 50% when exiting the material:

Figure 56a
Pre-Chamfer to Eliminate Burrs

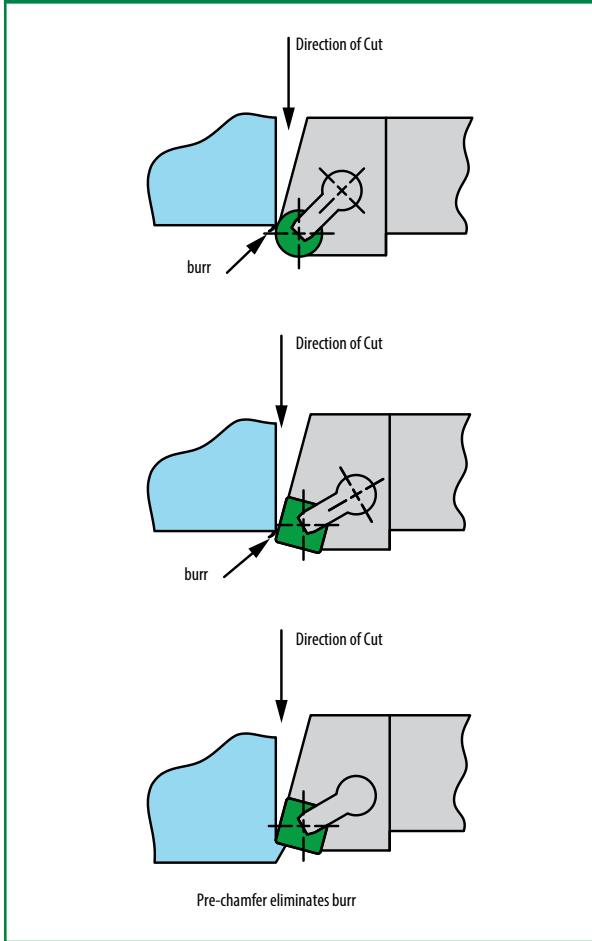

In ductile materials (S, M, H2) this also prevents the thin and plasticized wall of material from coiling over and forming a burr.

2. Direction and magnitude of cutting forces

Always consider the direction and magnitude of the cutting force produced by the chosen tool with respect to the geometry of the workpiece and the location and rigidity of the fixture. The greater the length of the edge engaged in the cut – the greater the cutting forces. So, higher lead angles will result in higher cutting forces, and round inserts will produce higher cutting forces at the same depth of cut than straight-edged inserts at a lead angle of 45° or less. Higher lead angles will also direct a greater portion of the resultant cutting force perpendicular to the machined surface. Machining in a direction that does not have sufficient rigidity in the component – when there is no clear compressive path for the stresses to flow into the fixture, will likely lead to deflection, vibration, and irregular wear.

Figure 56a
Cutting Direction Resultant Forces

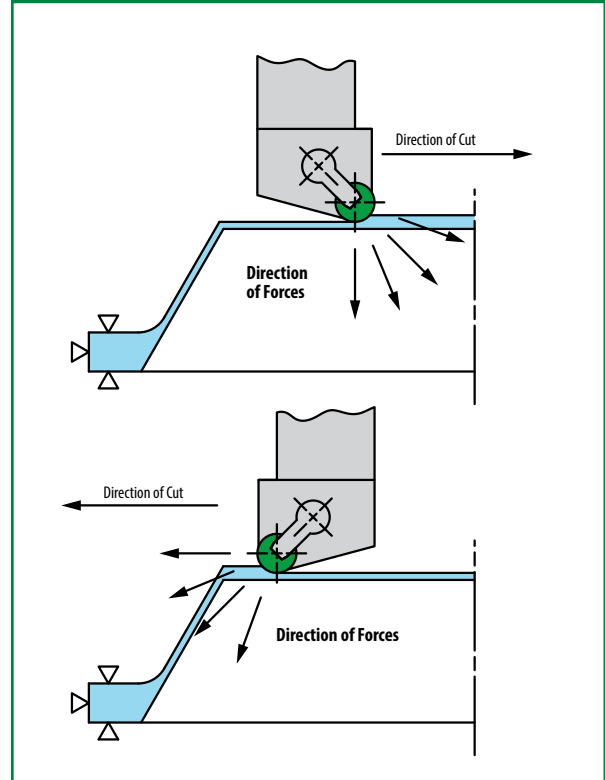

3. Round vs. straight-edged

Round inserts should be used in ceramic machining whenever possible, because they are strongest and most versatile.

The main downside to using a round insert is that at equal cutting conditions and with the same edge preparation the cutting forces will be significantly higher than with a straight-edged insert (at a lead angle of, say 45°), owing to the higher length of edge in the cut.

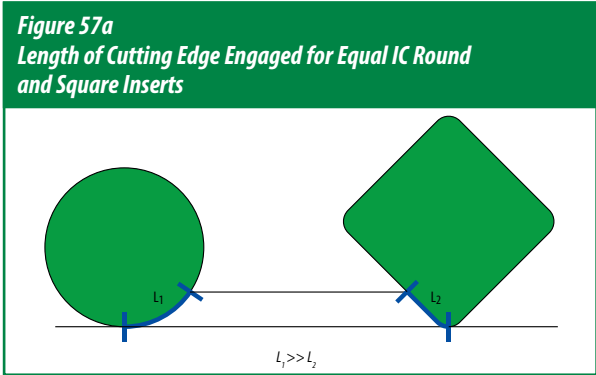

Higher cutting forces mean higher spindle loads (so one may also run into machine power as a limitation when using round inserts), but also higher mechanical stresses that the component and tool have to carry without deflecting. An extreme case would be the use of a round negative insert for small-ID and large OAL boring – often this is impossible and a straight-edged insert has to be used instead. S and M material groups' tendency to strain-harden, however, means that the higher cutting forces that a round insert produces have to be weighed against the lower resistance to notching of straight-edged inserts, particularly at lower lead angles. Some instances warrant the use of an SNGN for roughing instead. XSYTIN®-1 is particularly well-suited for this in S materials because of its superb resistance to notching – more on this in the section on machining heat-resistant super alloys.

4. Turning to a shoulder

One of the most common operations encountered in all turning is machining to a flange or shoulder. Regardless of the shape of the insert, approaching the shoulder leaves no room for the chips to flow, trapping them between the tool and the part and increasing cutting forces. If higher spindle loads are observed with a straight-edged insert machining to a shoulder, reduce the feed by 50% in subsequent passes.

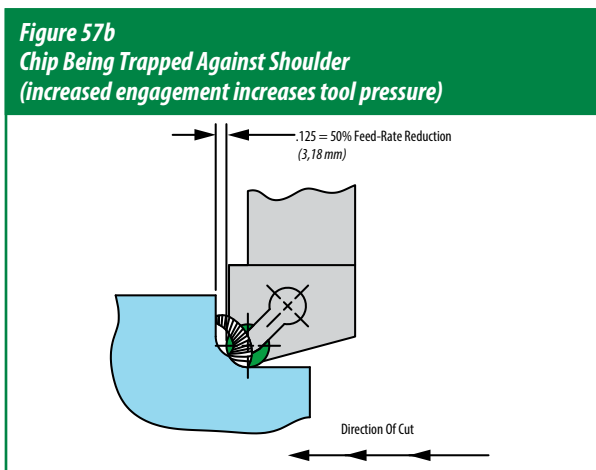

From the perspective of chip thickness, turning to a shoulder with an insert with a small corner radius actually presents less of a challenge, but as the corner radius grows and round inserts or full-nose grooving inserts are used, more and more material is left at the shoulder for subsequent passes, so that, eventually, the depth of cut grows to the radius of the insert when approaching the shoulder as seen in Figure 57b above.

Without a reduction in feed, this causes the chip thickness to increase considerably as the lead angle approaches 0, and causes the cross-sectional area of the chip to grow considerably, increasing the cutting forces. The increase in chip thickness changes the heat distribution, while the increase in cutting forces may exceed the strength of the insert leading to flaking or top-slicing or, in extreme cases, fracture. With access to CAM or validation modules that can track chip thickness and adjust the feed rate when generating the tool path this is no longer a concern because feed will be adjusted in the program with the increasing depth of cut. Otherwise, a reduction of feed on the order of 50% is recommended for the segment of the tool path where depth of cut starts to grow at the shoulder.

5. Connecting tool path segments

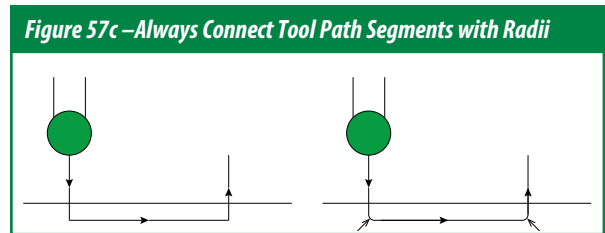

It is paramount to have **NO** sharp points in the tool path. All segments must be connected by a radius, no matter how small, but preferably the larger the better. Any sharp points in the path will result in sudden changes of direction and/or magnitude of cutting forces, or dwell if the feed speed is too high for the dynamics of the machine. That being said, CNC is not a prerequisite for ceramic machining, especially on a lathe.

6. Face-turning to center

Ceramics do not tolerate near-0 cutting speed because the strain rate approaches 0, as does heat that is so necessary in reducing the strength of the workpiece material and thereby reducing cutting forces. It is generally not recommended to machine with ceramics in conditions that approach 0 cutting speed. Some exceptions can be made and it can, on occasion, be done successfully, but as a rule – drill a hole with carbide before face turning whenever possible.

Heat Distribution

As previously mentioned in the section on chip thickness, heat generation and evacuation are pivotal in the ceramic machining process. Since chip thickness is affected by the lead angle and feed, chip thickness for round inserts is a function of the radius of the insert, feed, and depth of cut.

Figure 58a
Lead-Angle Effect on Round vs. Straight-Edged Inserts and the Theoretical Chip Thickness

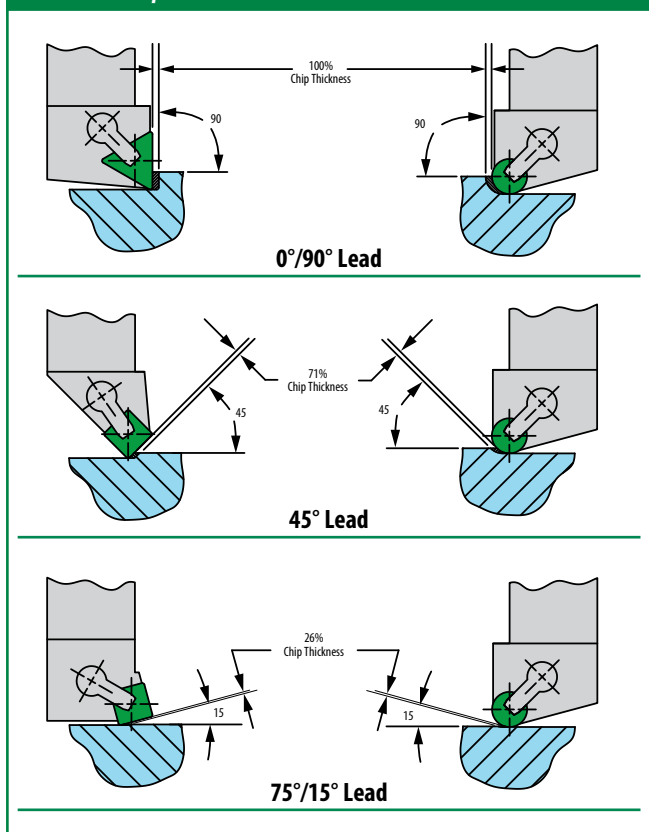

Using a smaller or larger insert, or changing the depth of cut with a round insert will change the chip thickness and affect the heat distribution. Increasing the chip thickness removes more heat from the cutting zone, and reducing the chip thickness does the opposite.

The best scenario is one where a CAM or validation module is used to monitor the chip thickness to adjust the feed rate based on the radius of the insert and the depth of cut at which the insert is currently engaged.

Failing that, feed rates need to be programmed manually so that the chip thickness that is found to be optimal at a given speed is kept constant. Changes to chip thickness alter the heat distribution and will likely lead to irregular wear, lowering tool life. This is especially important in the machining of S-class materials, but also applies to all ceramic machining.

Cutting Tool Material Properties

Al_2O_3 -based ceramics are inherently different from Si_3N_4 -based ceramics. Alumina-based grades are harder, more wear-resistant, more chemically stable at higher temperatures, but less resistant to notching whereas silicon nitride is tougher, stronger, more resistant to thermal shock, but starts to oxidize around $1000^\circ C$ (1832 F). It is no surprise then, that applications requiring wear resistance and hot hardness are best tackled with whisker-reinforced ceramics, while applications requiring strength, toughness, and resistance to thermal shock should be addressed with XSYTIN®-1.

It also follows that, as far as optimal chip thickness is concerned, having a lower chip thickness is more damaging to XSYTIN®-1 (too much heat), and having a higher chip thickness is more damaging to whisker-reinforced ceramics because the mechanical stresses may be too high, or there may be insufficient plasticization.

Some materials remain ductile and retain strength despite high strain rates and plasticization, and so require cutting tools that exhibit both high fracture toughness and transverse rupture strength. These materials, previously not machinable with ceramics, can now be machined with XSYTIN®-1.

Material-Specific Guidelines

Heat-Resistant Super Alloys (S)

The importance of chip thickness in machining of heat-resistant super alloys cannot be overstated. Suffice it to say that if you deal with the production of large quantities of complex components in nickel- or cobalt-based HRSAs then tool life and therefore cost of tooling per component could be dramatically improved through the use of a CAM or verification module that has the ability to adjust programmed feed to keep chip thickness constant.

Nickel- and cobalt-based alloys are very susceptible to strain-hardening. This means that even if there isn't a carbide/oxide-rich forging scale, the surface of the component after every subsequent pass in turning or milling is harder than the rest of the workpiece. The strains that the surface is subjected to as it is being machined dictate the degree to which strain-hardening occurs. So, using a negative ceramic insert with a negative edge preparation at negative rake angles will strain-harden the surface considerably more than a very positive carbide insert with a positive chipform and 0 or positive rake.

Regardless of which machining method preceded the operation now being addressed with ceramics – the surface is harder, and, unless specific measures are taken, notching is a concern.

Because of differences in material properties, whisker-reinforced ceramics are more prone to notching than XSYTIN®-1. The best tool path for WG-300® can vary significantly from the best tool path for XSYTIN®-1.

Forging Scale Removal

Forging scale in S materials goes hand in hand with some degree of runout and presents the first challenge in machining. One false assumption that should be dispelled is that the depth of cut must be kept low to reduce stresses and prevent the insert from flaking – on the contrary, because of the quantity of large, hard particles, keeping the depth of cut low will result in aggressive abrasive wear that will grind down the flank, weakening the edge and making catastrophic failure more likely. The cutting edge should be below the scale for as much of every revolution as possible – ideally 100% of the time. The higher the runout, however, the higher the maximum depth of cut needed to keep the edge of the insert in clean material for scale removal. This means higher cutting forces, a higher lead angle for round inserts, and a higher chance of notching.

Due to their higher edge strength and resistance to notching, round inserts are generally recommended for forging scale removal; but if the radial runout and cutting forces are too high, manifesting as deflection, vibration, or high spindle loads, a straight-edged insert in XSYTIN®-1 at a lead angle of 45° or higher can be used for outstanding results instead.

Because of the difference in hardness between the scale and the material below it, it is almost impossible to find a set of cutting conditions at which the wear would be regular in both, so some notching is always expected. However, with XSYTIN®-1's transverse rupture strength and toughness, we are able to apply it at conditions that are optimal for the hardness of the scale without fearing irregular wear in base material. It is recommended to reduce both speed and chip thickness by 20-30% from optimal cutting conditions in clean material for both XSYTIN®-1 and whisker-reinforced ceramics when machining forging scale.

Roughing: Straight Cuts

Whisker-reinforced ceramics and XSYTIN®-1 are both extremely capable of productive and reliable roughing of heat-resistant super alloys that can reduce cycle times by a factor of 4 or more compared to coated carbide. Whisker-reinforced ceramics generally perform better in stable environments capable of sustaining high speeds without any loss of rigidity or increase in vibration. XSYTIN®-1 performs better in applications with cutting speed limitations, in unstable environments, but in machines that are nevertheless capable of producing enough power at the spindle, because with the lower strain rates and higher chip thickness that are optimal in applying XSYTIN®-1, cutting forces can be as much as double those for WG-300®. This also makes sense because the transverse rupture strength of XSYTIN®-1 is roughly double that of WG-300® and cutting tools should be applied at the limit of their material properties to maximize productivity.

Whisker-Reinforced Ceramics

1. Optimal depth of cut

When notching is the primary mode of wear – i.e., the wear that progresses quickest and ultimately limits tool life, round inserts and straight-edged inserts with a corner radius should be applied at or below 45° radial engagement. The higher the lead angle – the higher the component of the cutting force acting perpendicular to the cutting edge – the stronger the notching. Reducing the depth of cut while keeping the chip thickness constant, however, reduces the rate of metal removal, because the increase in feed does not keep the cross-sectional chip area constant. And so, the right compromise between tool life and productivity must be found.

Figure 55b
Recommended Depth of Cut for Round Inserts

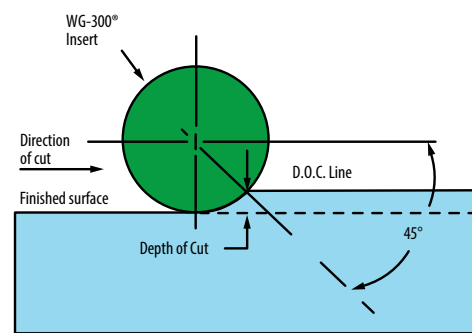

Insert Radius		Optimum Depth of Cut	
Inches	Millimeter	Inches	Millimeter
.125	3,18	.037	0,93
.187	4,76	.052	1,40
.250	6,35	.073	1,86
.312	7,94	.092	2,33
.375	9,53	.110	2,79
.437	11,11	.128	3,26
.500	12,70	.147	3,72

When notching is not the primary concern and wear is regular, a better balance between the rate of metal removal and wear is reached at 60° engagement with round inserts in whisker-reinforced ceramics.

Figure 60a
Recommended Depth of Cut for Insert Nose Radii

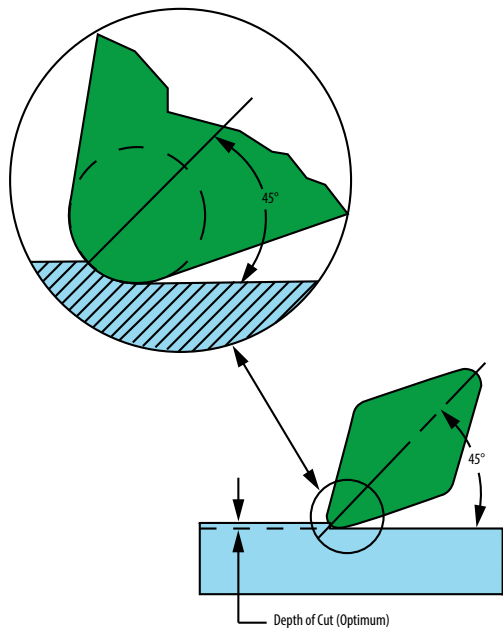

Insert Radius		Optimum Depth of Cut	
Inches	Millimeter	Inches	Millimeter
.015	0,38	.0046	0,12
.031	0,80	.0092	0,23
.048	1,21	.0139	0,35
.063	1,59	.0183	0,47
.094	2,38	.0275	0,70
.125	3,18	.0370	0,93

2. Taking fewer passes

Reducing contact time is generally beneficial to wear so long as the same or higher quantity of material is removed per operation. So, when applying a straight-edged insert, and so long as cutting forces aren't too high – the wear is regular, there is no deflection-vibration, the spindle load is not too high – take fewer passes at a higher depth of cut instead of multiple passes at a lower depth of cut. This also extends tool life by using more of the insert, distributing the wear over a greater portion of the cutting edge.

Figure 60b
Rethink Depth of Cut

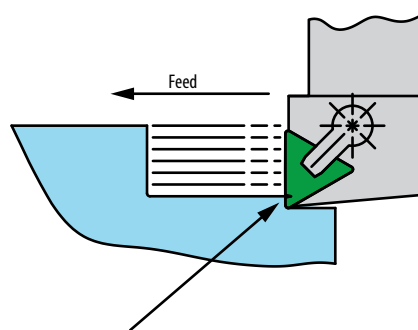

Multiple passes at the same depth of cut causes notching at weak section of insert.

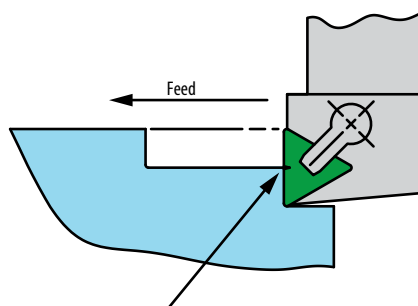

Fewer deep passes moves notching to a stronger section of the insert.
(A reduction of feed rate will be necessary.)

3. Varying the depth of cut

Since notching occurs at the depth of cut it makes sense to distribute the notching and vary the depth of cut between passes instead of repeating multiple passes at the same depth of cut. If notching is the primary mode of wear – depth of cut should be reduced with each subsequent pass to present an un-notched edge to the cut. If wear is regular then depth of cut should be increased with each subsequent pass instead. Always keep in mind that with round inserts changing the depth of cut affects lead angle and feed rate must be adjusted to keep the chip thickness constant.

Figure 61a
Multiple Passes at the Same Depth of Cut

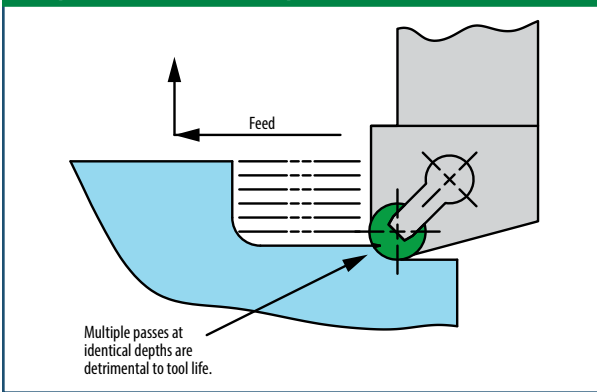

Figure 61b
Multiple Passes at Varying Depths of Cut with Notching

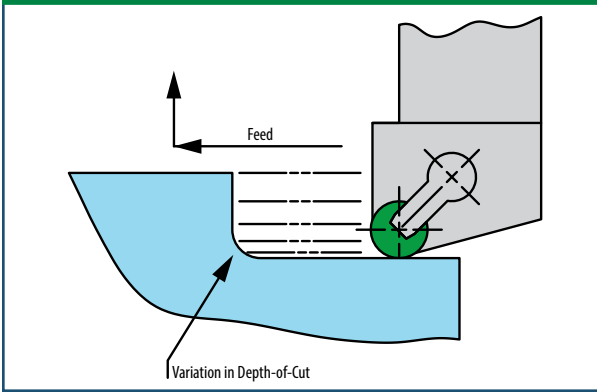
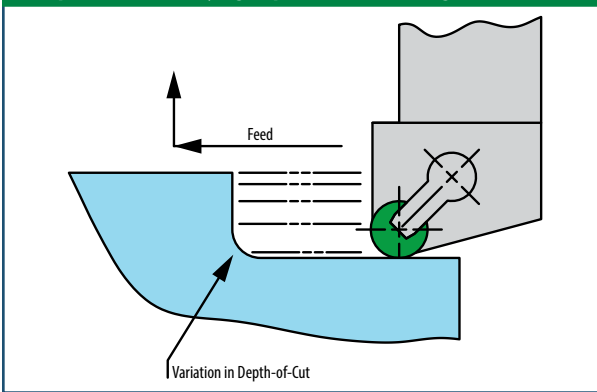

Figure 61c
Multiple Passes at Varying Depths of Cut with Regular Wear



4. Ramping

The best way to vary the depth of cut if notching is the primary mode of wear is to vary it continuously by ramping. Ramping on straight cuts can be done with both negative and positive inserts. Negative inserts can only be used to ramp out and then ramp in by doing a subsequent straight pass (as in Figure 61d) while positive inserts can be used to ramp in, plunge, and carry out sinusoidal ramping (as in Figure 61e) though ramping out following a plunge is preferable because the cross-sectional chip area decreases as wear increases – resulting in lower peak loads than ramping in.

Note that in all cases, optimal chip thickness must be kept as close to constant as possible for a given speed. For passes that are sufficiently short – say, a minute or less in cut time, split the ramp into four segments and assign a feed value to each segment that would, on average, result in the right chip thickness. For longer passes – increase the number of segments. Finally, the more aggressive (steep) the ramp – the more segments should be programmed to reduce the variation in chip thickness.

Figure 61d
Multiple Passes Using Ramping Technique

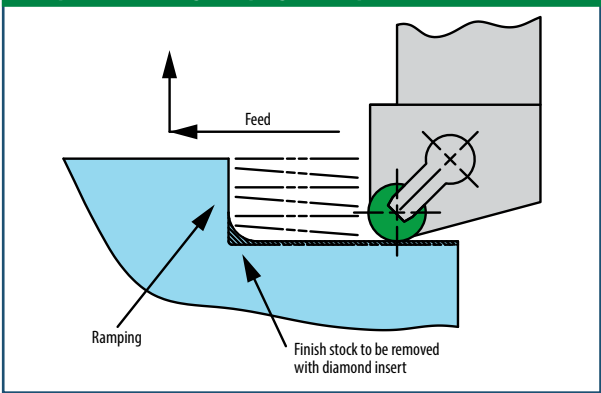
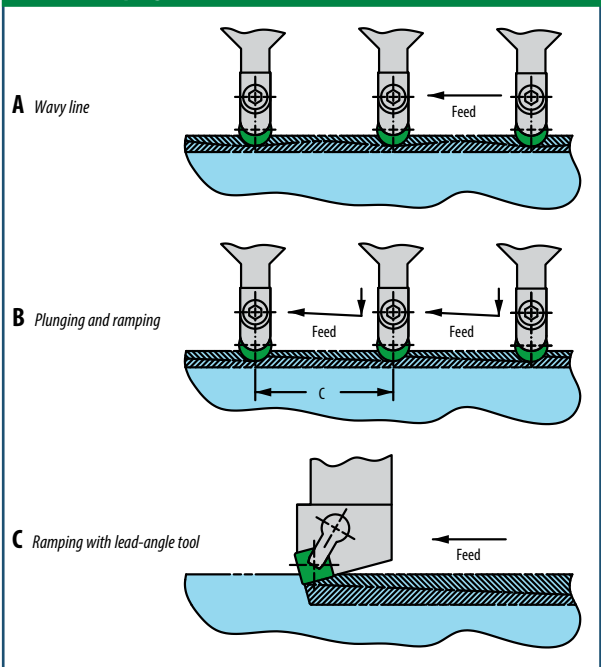

Figure 61e
Various Ramping Methods



XSYTIN®-1

Because XSYTIN®-1 is considerably stronger and more resistant to notching but less stable at higher temperatures compared to whisker-reinforced ceramics, the main concern when applying XSYTIN®-1 is to avoid any tool paths where the chip thickness drops off and the heat in the cutting zone increases beyond optimal levels.

Since notching is generally less common, there is less need to vary the point of contact between the surface of the workpiece and the tool. In fact, ramping, especially when depth of cut is low, can be detrimental to tool life because the chip is not sufficiently thick to carry enough heat out of the cutting zone.

1. Optimal depth of cut

Because of heat, optimal cutting speeds for XSYTIN®-1 are always lower than those for whisker-reinforced ceramics. Because of the lower strain rates, the material is typically more ductile and stronger, and requires higher effort to be sheared off. Because of the increased ductility the chip also doesn't break as easily, which can lead to crater wear. To avoid crater wear entirely, the optimal depth of cut for round XSYTIN®-1 inserts even where whisker-reinforced ceramics notch, is greater than 60°-65° radial engagement.

Figure 62a
Recommended Depth of Cut for Round Inserts (XSYTIN®-1)

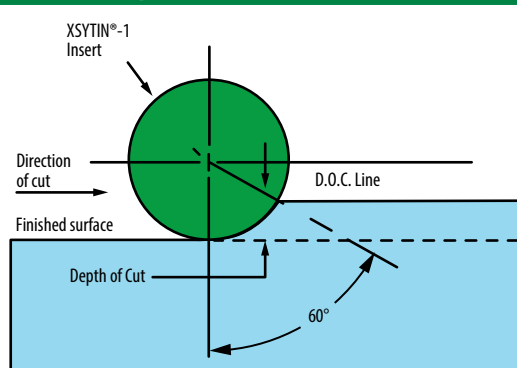

Insert Radius		Optimum Depth of Cut	
Inches	Millimeter	Inches	Millimeter
.125	3,18	.063	1,50
.187	4,76	.094	2,38
.250	6,35	.125	3,18
.312	7,94	.156	3,97
.375	9,53	.188	4,76
.437	11,11	.219	5,55
.500	12,70	.250	6,35

The higher the curvature of the chip (the higher the depth of cut with a round insert) the less likely it is that the chip will stay intact as it separates from the workpiece.

2. Taking fewer passes

Reducing contact time is generally beneficial to wear so long as the same or higher quantity of material is removed per operation. While the cutting forces aren't too high – wear is regular, there is no deflection-vibration, the spindle load is not too high, take fewer passes at a higher depth of cut instead of multiple passes at a lower depth of cut.

3. Round vs. straight-edged

Because of XSYTIN®-1's resistance to notching and edge strength, straight-edged inserts (SNGN, for example) can be used at 45° or higher lead angles in heat-resistant super alloys to reduce cutting forces at the same depth of cut, or significantly increase metal removal rates at the same spindle load.

Roughing: Opening Cavities

The two mechanically different approaches to opening cavities are grooving and profiling. While grooving is indisputably more productive, it is also more costly, and generally requires more sister tooling. Profiling (the use of a v-bottom positive round insert or a full-nose grooving insert) is the most cost-effective, but not the fastest.

There are, ultimately, three styles of inserts, then, that can be used in combination to open cavities:

- V-bottom positive rounds – e.g., RPGN-3V
- Full-nose grooving inserts – e.g., WG-6250A, where the last three digits denote the width of the insert in 1/1000ths of an inch, and the 'A' stands for 'A-hone'
- Flat-nose grooving inserts – e.g., WG-6250-2A, where the last digit indicates the corner radii of the insert in 1/64ths of an inch

Figure 62b
Insert Styles Used in Combination to Open Cavities

V-Bottom Positive Round Insert

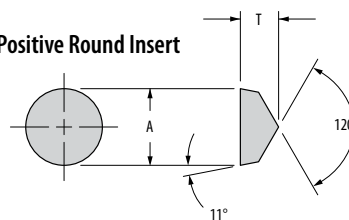

Full-Nose Grooving Insert

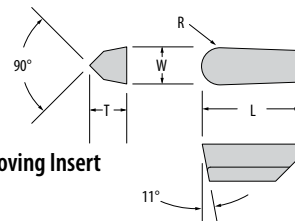

Flat-Nose Grooving Insert

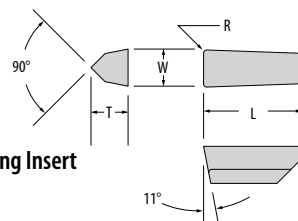

Grooving

When the corner radii of the cavity are small (0.050" / 1.2mm or less) using a flat-nose grooving insert makes the most sense, but notching is difficult to avoid with partial engagement of the insert. If the material being machined is sufficiently strong (e.g. all S2 alloys in the STA condition), chips will shear off well and burring will not occur. If, however, we are grooving an S1 alloy, it is likely that following the method shown in Figure 56 will result in a thin wall of the material peeling off despite the fact that the width of the machined area is smaller than the width of the insert. To avoid this, and assuming some productivity can be sacrificed for reliability, we recommend using a full-nose grooving insert or a round v-bottom insert to profile the cavity as discussed in the 'Profiling' section below.

Alternating the plunge order to engage the insert fully instead of stepping over and having a slight imbalance in cutting forces with higher susceptibility to notching is not recommended because the flanges left to machine between grooves are generally not rigid, which, combined with the relative flexibility of the grooving blade typically leads to vibration and irregular wear.

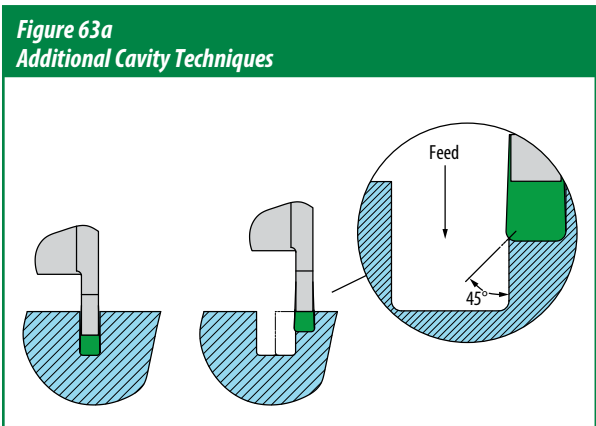

Note that grooving with a round V-bottom insert or a full-nose grooving insert is an exceptionally stable and effective operation, provided the machine has enough power and the workpiece/tool/fixture are sufficiently rigid. The only downsides are the scallops that are left and have to be machined at the end, any resulting burrs, and the difficulty in chip breaking.

The feed rates recommended for grooving differ from the feed rates recommended for regular turning because the cutting forces that would be produced if regular chip thickness recommendations were followed would exceed the strength of the cutting tool for most narrow groovers. Instead, use the same cutting speed as in turning, but determine the feed from Figure 63b below:

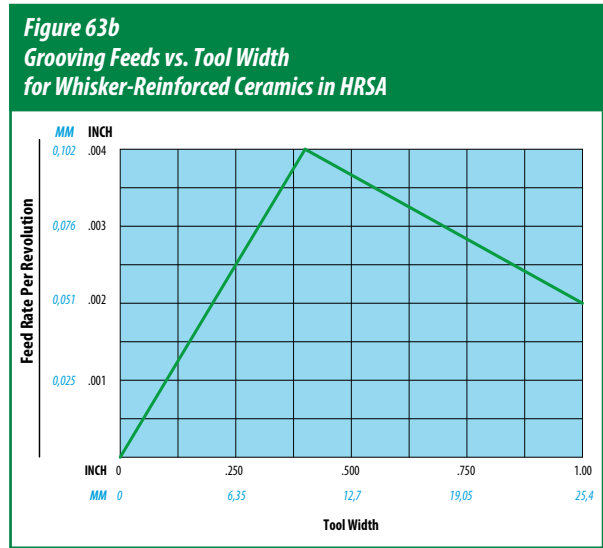

For XSYTIN®-1, increase the feed from the determined value by a factor of x1.5.

Grooving and Profiling

An alternative to the methods above would combine a flat-nose grooving insert and a round (RPGN or WG-XXXX) insert using the flat-nose groover first, removing the remaining stock with a round, and doing a final blend cut with the flat-nose groover if necessary.

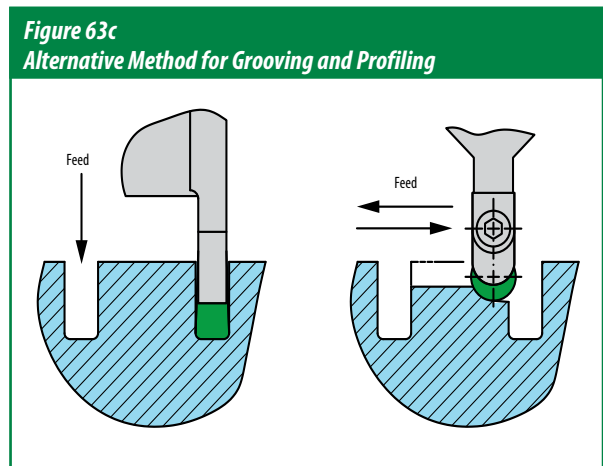

Profiling

Provided the corner radii of a cavity are sufficiently large, profiling is a method that requires only one tool to complete the operation. Here a V-bottom round insert or a full-nose grooving insert are used to feed in multiple directions.

Whisker-Reinforced Ceramics

To avoid notching, the most effective method of profiling with whisker-reinforced ceramics is ramping. To start the cut, one can either plunge into the material or ramp into it – both with their pros and cons. Plunging allows ramping out, which alleviates the stress on the tool towards the end of the cut. Because we need to avoid any sharp corners in the tool path, however, plunging should be connected to the ramp by a radius sufficiently large to allow the machine to execute the cut with no sudden changes in direction, which is slightly more difficult to program while keeping the chip thickness constant. Plunging on a radius followed by feeding perpendicular to the axis of the tool is known as trochoidal turning. With whisker-reinforced ceramics, plunging on a radius is a great way to enter the material, provided the path then follows a ramp (in or out) and chip thickness is kept constant throughout.

Figure 64a – Plunging Followed by Ramping out

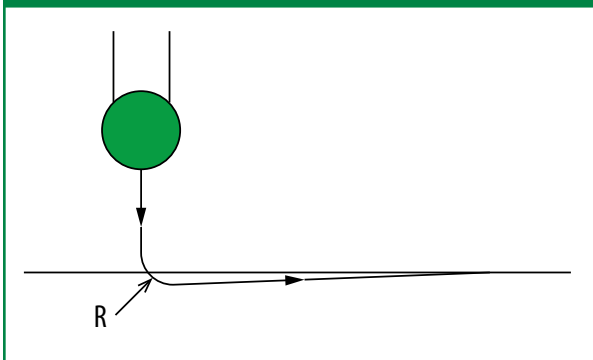

Ramping in is generally better for mechanical stresses, but will end with the insert at its highest wear approaching the shoulder. In the following passes, this tool path will require a significant reduction in feed when approaching the shoulder because the depth of cut will grow to the radius of the insert, where the lead angle and chip thinning are 0.

Figure 64b – Ramping in

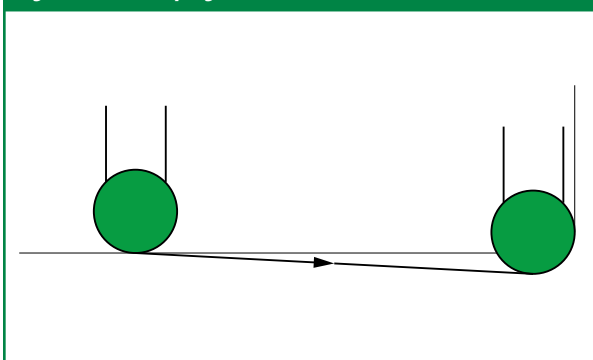

Throughout both ramping methods, chip thickness must be kept constant to preserve the balance of heat. Plunging should be done at a feed rate equal to the recommended chip thickness since the chip thickness then equals the feed rate, with feed rate adjusted in all other paths to conserve chip thickness for the given speed and insert radius.

XSYTIN[®]-1

Since notching is generally not a concern, profiling with XSYTIN[®]-1 needs only to minimize the variation in mechanical stresses but depth of cut can usually be kept constant. Ramping where the depth of cut is below 60° engagement is not recommended. Ramping, in general, is not needed and the most efficient and productive method is to use trochoidal turning.

Figure 64c – Trochoidal Turning

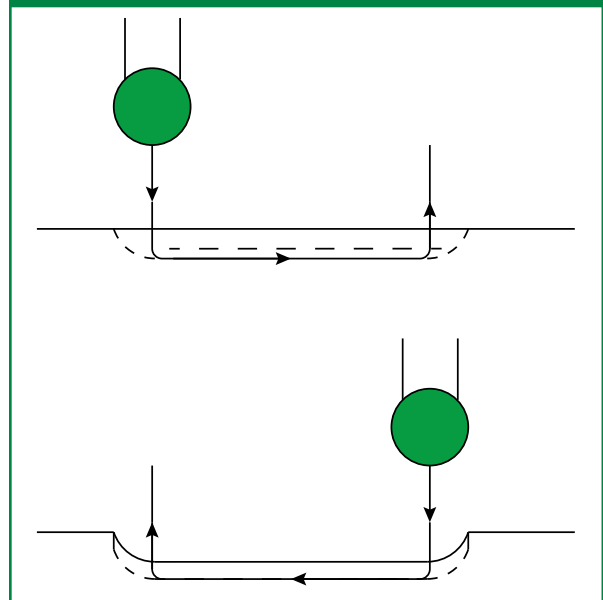

When programming the tool path, use a radius of twice the radius of the insert for entry and exit to reduce radial engagement. And as always, adjust feed rates to keep chip thickness constant throughout.

Radial Engagement a.k.a. Wraparound

One final aspect that should be considered when profiling is the direction from which a cut should be executed given surfaces that do not meet at a right angle.

Figure 65a
Tool Engagement Angle

Maintaining a reduced engagement area as shown is preferred. If the increased engagement area is unavoidable, then a 50% feed reduction may be necessary.

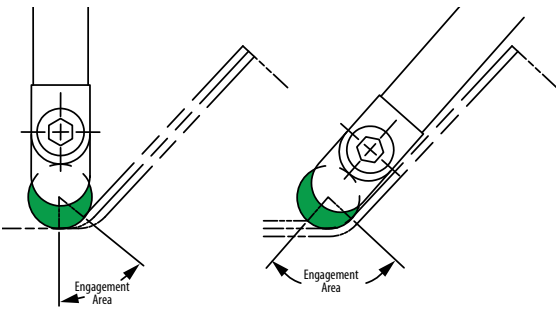

Preferred - reduced engagement area

Semi-Finishing

Semi-finishing is an operation that is carried out at a low depth of cut and removes any material left over by larger inserts, mismatches, excessive internal surface stresses, and otherwise prepares the workpiece for finishing.

Fillets and Shoulders

The most common semi-finishing operation requires the removal of material left behind by round inserts in corners. To avoid notching, the best methods are as follows:

Figure 65b
Finishing a Fillet Using an 80° Diamond Insert (Plunge Cut)

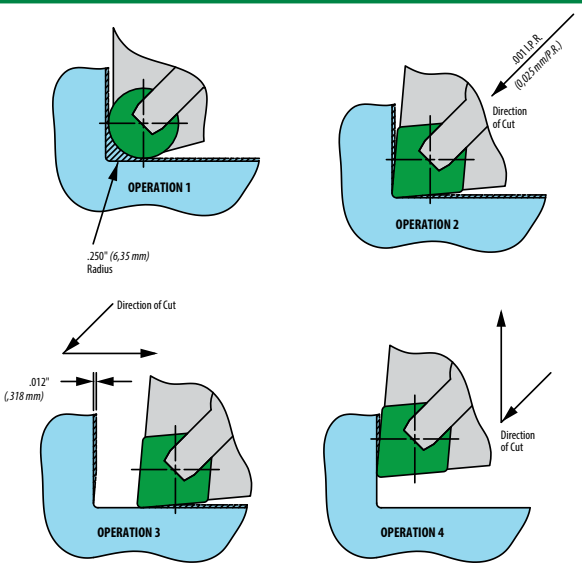
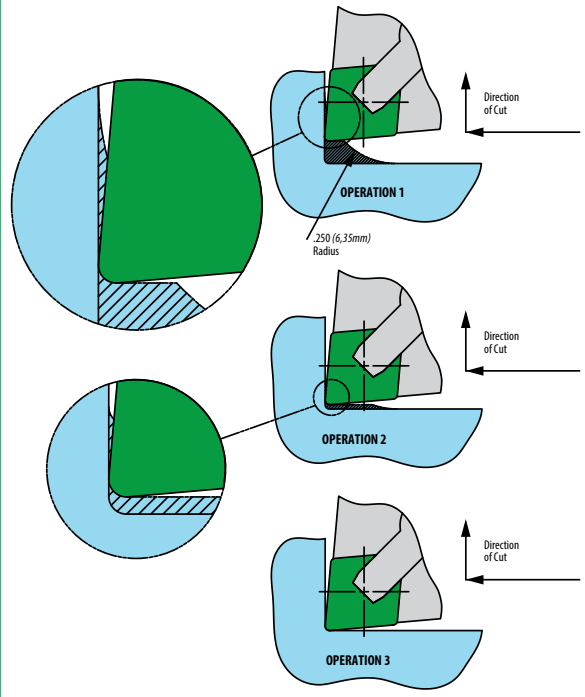

Figure 65c
Ramping Effect on Shoulder Cuts

In this method, a CNGN452 (12 07 08) insert is shown in the finish operation on a fillet roughed with a RNGN45 (12 07 00) insert leaving a .250" (6,3 mm) radius. The finish operation is performed by feeding several times into the fillet. It is essential when the wall is reached to *immediately* raise the tool vertical to remove the scallop which would otherwise be left on the wall. This material will tend to cool and present a hardened, irregular surface needing a subsequent operation. The finish passes described will tend to notch the tool and should be programmed at various depths to reduce this effect. The final pass should be less than the 45° line of the tool nose radius.



Corners in a Cavity

Semi-finishing of corners in a cavity requires the use a flat-nose grooving insert to produce the corners and blend the cut, as seen in Figure 66a.

Figure 66a
Turning to a Shoulder in Cavities with V-Bottom Grooving Inserts

This example shows the profiling of the groove or cavity using a V-bottom grooving insert. It is important to keep the finish stock very light on the sides so that the cut is below the 45° mark on the insert radius. This will vary with the radius needed. The larger the radius, the greater the stock can be.

In the corner itself, we use the “ramp” inherent in the radius left by the round insert used for roughing to reduce or eliminate notching of the tool. This is a further benefit of roughing with round inserts or profiling the corner in the program.

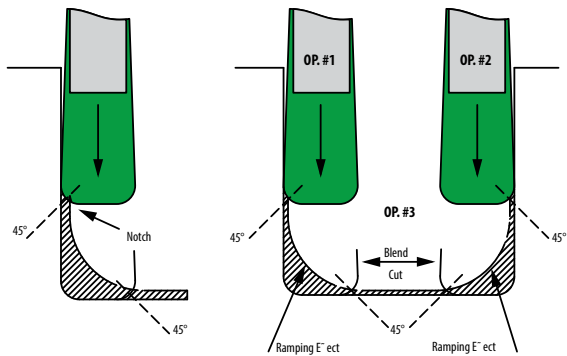

Watch the depth-of-cut line!

Leaving less than 0.0079” (0.2mm) of stock material for finishing is not recommended, especially when using the T1 edge preparation – the insert may refuse the cut, bouncing along the surface and smearing the material instead of cutting it. However, GF-1 (below) is able to take much lower depths of cut consistently and reliably – as little as 0.002” (0.05mm).

Leaving too much material poses the risk of notching, as seen in Figure 66b below.

Figure 66b
Carbide Method Beware

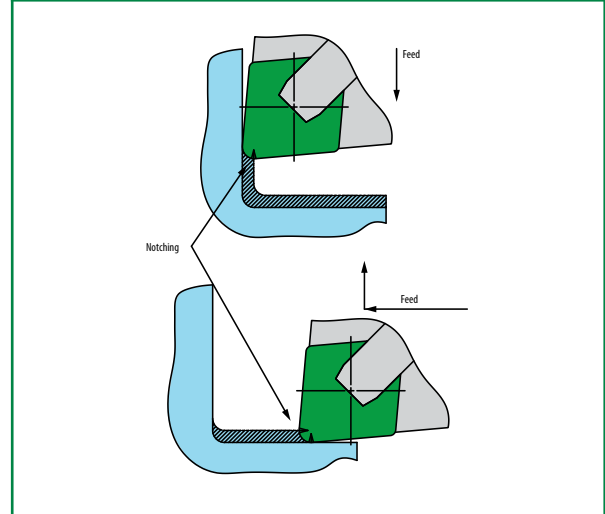

The ideal amount of material would be such that the straight-edged insert executing the finish cut is engaged to 45° of the corner radius.

Figure 66c
Ceramic Method

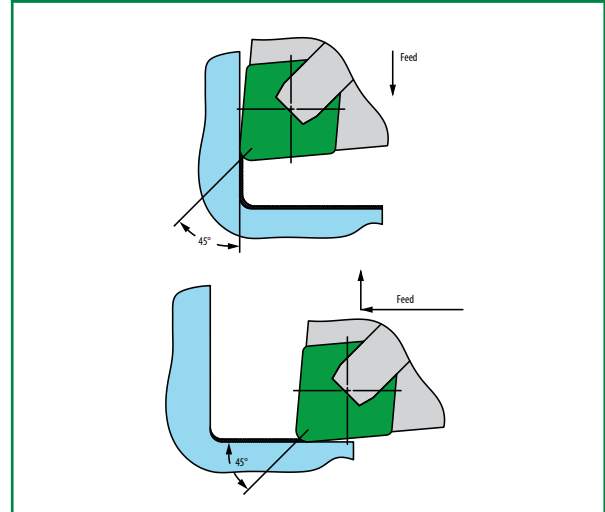

Finishing

Finishing is the final stage of machining that leaves the surface in the desired condition with the appropriate Ra, Rz, acceptable thickness of deformed layer, and magnitude of internal stresses.

Because of the very strict requirements on surface quality of heat-resistant super alloys, particularly in critical rotating parts in aircraft engines, the finishing is typically done with WC-Co tools. Greenleaf’s whisker-reinforced ceramics, however, are exceptionally well-suited for the task of finishing heat-resistant super alloys.

WG-600

Following grinding, the edge of any ceramic (or CBN/PCD) insert is ultimately a well-aligned collection of jagged peaks. The coating of WG-600® levels these peaks out, providing a smoother surface with which to remove material, which itself produces a smoother surface (especially after the coating has “worn in” slightly) and protecting the substrate from heat and abrasive wear. With the high strain rates and plasticization of whisker-reinforced ceramics in heat-resistant super alloys, chips separate well and the surface finish is excellent.

GF-1

GF-1 is a chipform that Greenleaf adds to round v-bottom inserts that makes the cut more positive. Combining the high strain rates and plasticization of ceramic machining with the positive rake angle of GF-1 significantly reduces the cutting forces and compressive stresses that the surface is subjected to. The result is a surface with fewer defects and a lower thickness of deformed layer than what is commonly seen in finishing with WC-Co tools.

Multiple OEMs and share partners have certified WG-300/600 GF-1 for finishing of critical rotating components in gas turbines.

Figure 67a – GF-1 Chipform



Figure 67b
Theoretical Surface Roughness

Roughness average		8	16	32	63	80	100	125	150	200	250
Micro inches (Ra)		0,2	0,4	0,8	1,6	2,0	2,5	3,1	3,8	5,0	6,3
Micro meter (µm)		0,2	0,4	0,8	1,6	2,0	2,5	3,1	3,8	5,0	6,3
Nose radius		Feed rate per revolution									
Inches	.0156	.002	.0025	.004	.0055	.0065	.007	.0075	.008	.010	.011
mm	0,40	0,05	0,06	0,10	0,14	0,17	0,18	0,19	0,20	0,25	0,23
Inches	.0313	.003	.004	.0055	.008	.009	.010	.011	.012	.014	.016
mm	0,79	0,08	0,10	0,14	0,20	0,23	0,25	0,28	0,30	0,35	0,41
Inches	.0469	.0035	.005	.007	.0095	.0105	.012	.013	.015	.017	.019
mm	1,19	0,09	0,13	0,18	0,24	0,27	0,30	0,33	0,38	0,43	0,42
Inches	.0625	.004	.0055	.008	.011	.0125	.014	.015	.017	.020	.022
mm	1,59	0,10	0,14	0,20	0,28	0,32	0,35	0,38	0,43	0,50	0,56
Inches	.0938	.0045	.007	.009	.013	.015	.017	.019	.021	.023	.026
mm	2,38	0,11	0,18	0,23	0,33	0,33	0,43	0,43	0,53	0,58	0,66
Inches	.125	.0055	.008	.011	.016	.018	.020	.022	.024	.027	.031
mm	3,13	0,14	0,20	0,23	0,41	0,45	0,50	0,56	0,60	0,69	0,79
Inches	.1875	.007	.0095	.0135	.017	.021	.025	.027	.030	.034	.040
mm	4,76	0,18	0,24	0,34	0,43	0,53	0,64	0,69	0,76	0,86	1,02
Inches	.250	.008	.011	.016	.022	.025	.027	.031	.034	.040	.044
mm	6,35	0,20	0,28	0,41	0,56	0,65	0,69	0,79	0,86	1,02	1,12

Thin-Walled Components

Components with thin walls are quite common in gas turbines. Because of the lack of rigidity, special measures must be taken to ensure that the component is produced reliably and efficiently.

1. Reduce and redirect cutting forces if there is deflection and/or vibration.
 - a. Use smaller-radius round and full-nose grooving inserts.
 - b. Use smaller-corner-radius straight-edged inserts.
 - c. Use a toolholder with a lower lead angle for straight edged-inserts.
 - d. Use positive inserts at $0^\circ/0^\circ$ rake instead of negative inserts at $-5^\circ/-10^\circ$
 - e. Use a lighter edge preparation for more positive cutting (uncoated instead of coated, un-honed instead of A-hone, A instead of T1, T1 instead of T1A, T1A instead of T2A, or GF-1 instead of a flat top, for example), lowering the compressive stress in the deformed layer of the workpiece material.
 - f. Reduce the cutting speed and chip thickness proportionately.
2. Use whisker-reinforced ceramics instead of XSYTIN[®]-1 to reduce cutting forces so long as high-RPM machining is stable – there is no vibration at high speed.
3. Use XSYTIN[®]-1 if whisker-reinforced ceramics notch too quickly or if higher speed leads to vibration but the part and fixture can handle higher cutting forces at lower RPM
4. Do not continue to cut with an edge that exhibits irregular wear – avoid irregular wear at all costs
5. Apply high volume of coolant to the cutting zone to prevent the thin walls from becoming too saturated with heat – this may alter the microstructure of the material, scrapping the part

The following are two examples of thin-walled applications where simple adjustments to the process solved the problem:

Figure 68a
Thin-Wall Grooving

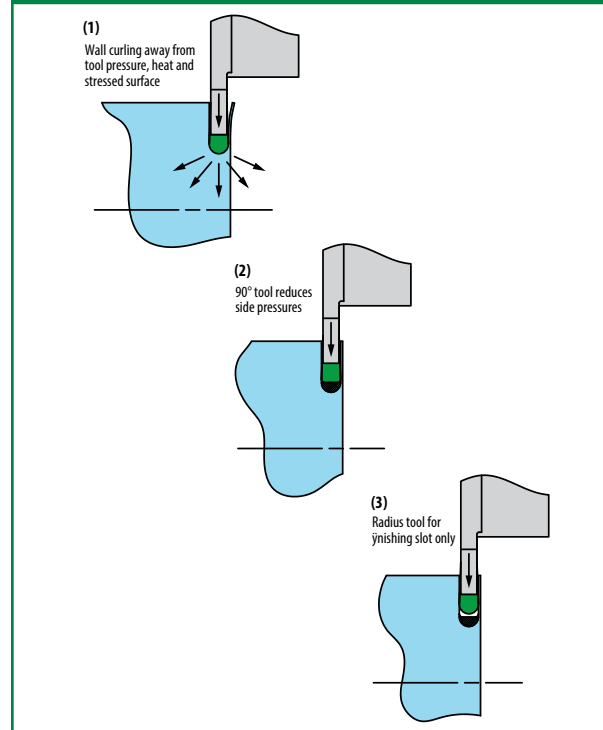
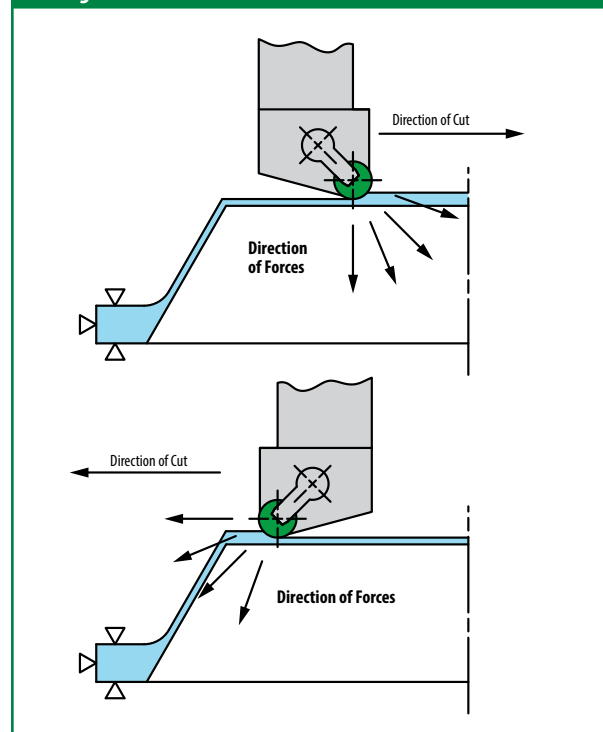
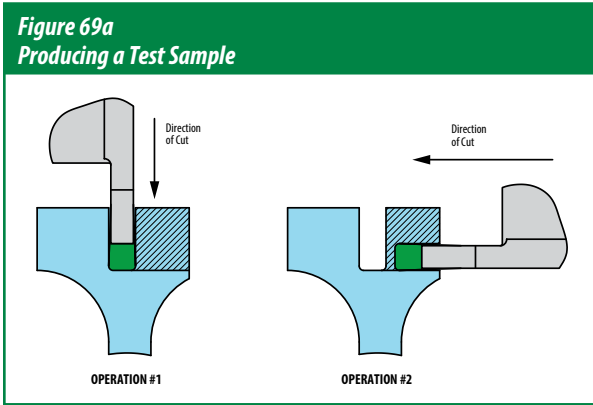

Figure 68b
Cutting Direction Resultant Forces



Test Ring Production



It is possible to make shoulder cuts with grooving tools involving the removal of large amounts of material by producing a complete ring.

This technique is being applied in the production of large gas turbine discs very effectively but requires a special set-up. The method is illustrated in Figure 69a.

In effect, two 90° opposing grooves are plunged into the part using a V-bottom grooving tool. This generates two clean walls and the required corner radius.

When the second groove breaks into the first one, a complete ring is produced. A fixture must be used to hold the ring as it parts from the main forging or else the tool will be damaged. It is worth constructing a special clamping fixture for such cases since the method itself is so economical.

Cut-Off

Face-turning or grooving to center reduces the cutting speed to 0, which ceramics generally don't tolerate. If it must be done – use XSYTIN®-1. Not reducing the speed to 0 is still very much preferred.

Coolant

Note: This section of the guide concerns continuous cuts and very light interruption only.

The heat produced in ceramic machining as a result of strain is beneficial, but having the heat accumulate in the workpiece and tool is generally detrimental to tool life. Coolant does not affect the heat distribution in the cutting zone, but it does influence the capacity of the tool and workpiece to carry heat away from the cutting zone. Excess heat conducted into the tool and workpiece from the cutting zone should be removed through coolant. Higher flow rates are more beneficial than higher pressure, though high-pressure coolant (HPC) will evacuate (and segment) the chips more expeditiously. HPC should be kept below 65bar for finishing operations – higher pressure of coolant tends to bombard the finished surface with the chips, resulting in a shot-peening effect.

Oil-based, water-soluble, emulsion-type coolants are best. The use of straight oils is to be avoided since the hazards of oil smoke and fire exist.

The delivery of coolant is quite important, particularly in grooving operations. It should be delivered as close to the cutting edge as possible, preferably through the clamp or tool.

Using a whisker-reinforced ceramic grooving tool and then completing the cut-off with a drill or boring tool in a secondary operation is shown in Figure 69b. This technique works best with smaller components where the cut-off piece can be captured on the drill or boring tool.

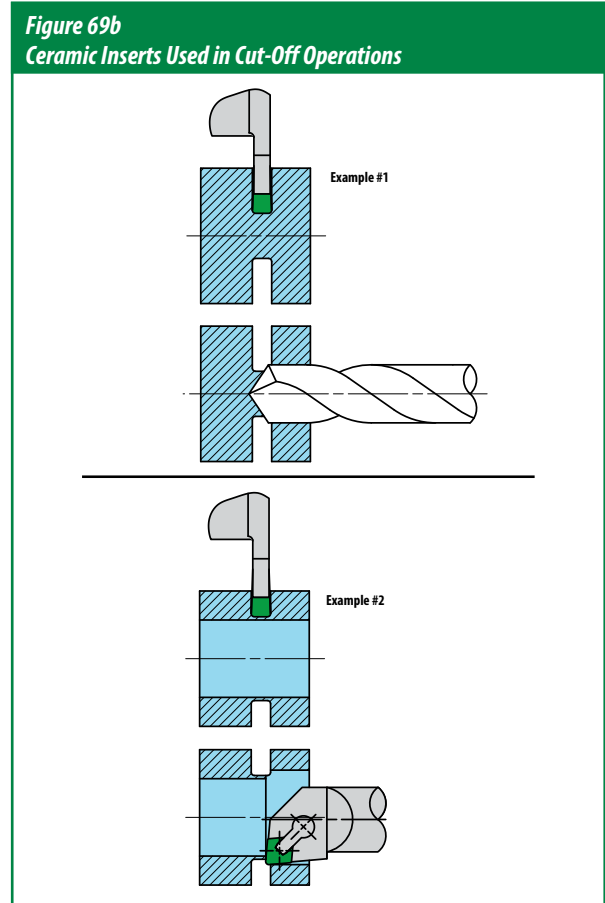

Stainless Steel (M)

M1, M2 (low-carbon), M3-M5

All the best practices covered in the section on machining S-class materials apply to the machining of stainless steel. There are two major distinctions that make austenitic, duplex, or low-carbon martensitic stainless steel more difficult to address with ceramics than even heat-resistant super alloys:

1. Because of the lack of high-temperature-strengthening mechanisms, the heat produced by the strain of ceramic machining lowers their strength to such an extent that the plastic deformation regime is dramatically extended. This means that the strain rates produced with negative inserts at standard rake angles at 1300 SFM (400m/min) are not sufficiently high to cause the deformed layer of the workpiece material to separate cleanly and segment as a result of further deformation (as intended in option 1 described in 'Chip Formation'), instead coiling off but remaining intact. Or rather, they would be sufficiently high if a high enough chip thickness could be sustained to evacuate much more heat from the cutting zone. But increasing the chip thickness increases mechanical stresses to where the strength of the cutting tool or the power available at the spindle are exceeded.
2. XSYTIN®-1 is typically not recommended in stainless steels.

In short – only whisker-reinforced ceramics should be used, and breaking the chip is very difficult.

There are some exceptions, of course:

- The free-machining grade 303 (304 with added sulfur) drastically lowers high-strain ductility of an otherwise very ductile 304, and chips form well.
- Cold-worked stainless steel is harder, stronger, and more brittle because of the higher density of dislocations introduced through strain-hardening.
- Precipitation-hardened stainless steels generally have higher strength at elevated temperatures, which can be exploited in chip formation as it is in heat-resistant super alloys. So higher-hardness PH stainless has more favorable chip formation.

In all other cases – high-pressure coolant is helpful but not by any means the conclusive solution to chip-breaking. So long as there is no or limited notching, increasing the depth of cut with a round insert will improve chip-breaking. So will increasing feed and reducing speed. Using positive inserts will produce a cleaner surface but will not help break the chip. Primary modes of wear are flank wear and crater wear, while notching is usually an indicator of excessive cutting speed, wrong insert geometry, or poor coolant delivery.

M2 (high-carbon)

High-carbon martensitic stainless steels have a similar microstructure to conventional hardened steel that is brittle at higher strain rates. Machinability is good, and positive inserts are usually not required. Strain-hardening is almost non-existent, so notching is rarely a concern. For workpieces with a hardness higher than 55 HRC, the edge preparation should always have a hone, and heavier lands may be required. Coolant should then not be applied. Primary wear is flank wear. Chipping and flaking are usually signs of insufficient cutting speed, and abrasive wear – that the speed is too high.

Coolant

See Heat-Resistant Super Alloys.

Hardened Steel (H)

H1, H3

Hardness and ductility in H1 and H3 steels are inversely proportional. So, at lower hardness edge preparations can be light, while beyond 50-55 HRC a wider (or even secondary) land is beneficial to tool life. Whisker-reinforced ceramics and XSYTIN®-1 are both very capable of turning the full range of hardnesses though XSYTIN®-1 generally performs better in softer steels and whisker-reinforced ceramics are preferable beyond 50-55 HRC. At optimal cutting conditions, primary wear is flank wear for alumina-based grades and crater wear for silicon nitride grades. Chipping and flaking may indicate that the speed is too low, while aggressive abrasive wear is usually a result of the speed being too high.

Coolant should not be used.

H2

Maraging steel is very difficult to machine. It is exceptionally strong, yet ductile, and cutting forces easily exceed those found in the machining of HRSA. XSYTIN®-1 is much better suited for the rough turning of maraging steel (in the tempered condition) than any other Greenleaf ceramic grade. The edge needs to be sharp (A-hone in the majority of cases), and to reduce cutting forces straight-edged inserts can be used instead of rounds. The primary mode of wear is crater wear. Excessive speed or chip thickness result in chipping.

High volume and/or pressure of coolant delivered to the cutting edge is essential.

H4

Carburized and/or nitrided steel is exceptionally abrasive, with large grains of carbides/nitrides between the grains of the parent alloy. GEM-8™ and whisker-reinforced ceramics are the primary choice, with heavy edge preparations to reduce abrasive wear and chipping in the white layer. Depth of cut should be sufficiently high to always be in the material, but not so high that the insert cuts through a very steep hardness gradient, though the white layer will always be considerably harder than the diffusion zone. Round inserts are strongly recommended. Primary wear is abrasive wear. Chipping is common.

Coolant should not be used. Unless the parent material is a low-carbon steel and the turning operation cuts into the diffusion zone – then the chips tend to stay intact and coolant will extend tool life appreciably.

Cast Iron (K)

K1, K2

Grey and nodular cast iron (not the kind used in roll production) are probably the easiest to machine among all the materials discussed in this guide. Shear strength is low since the material is brittle and cracks grow easily, and graphite lubricates the cut. GSN100™ is the best grade and T2 and T2A are the only edge preparations needed. Primary mode of wear is flank wear. Chipping and flaking are an indication of the speed being too low, the chip thickness being too high, or insufficient rigidity in the machining operation.

Coolant can be used but serves no purpose in the cutting process.

K3, K5

Most 'hybrid' materials are much more difficult to machine than either of the materials whose properties or microstructures they aim to combine. Such is the case with compacted graphite iron and austempered ductile iron. Other ceramics generally don't have the combination of fracture toughness and transverse rupture strength required to machine CGI and ADI, XSYTIN®-1 being the exception. Primary wear is flank wear, and T2 or A-hone can be used depending on the needs of the application. Irregular wear is uncommon and will only appear when the combination of chosen speed and chip thickness lead to excessive heat.

Coolant can be used but serves no purpose in the cutting process.

K4, K6

With the very high fraction of cementite and other carbides, K4 and K6 are more cermet than regular alloy. Extra care needs to be taken to protect the edge from chipping and abrasion – heavy edge preparations and high lead angles are recommended. Notching and flaking are possible when removing the scale – round inserts will work best there. With the right edge preparation (cases where special edge preparations have been necessary are not unheard of) and cutting conditions in clean material the primary mode of wear is flank wear. The choice between alumina-based grades and XSYTIN®-1 depends on the needs of the operation though higher hardness is a better fit for alumina-based grades rather than XSYTIN®-1.

Coolant should not be used.

Machining Strategy: Interrupted Cuts and Milling

Interrupted cuts are an area where most experienced machinists would not choose to use ceramics, because the first ceramics introduced in cutting tools were, understandably, less than promising in terms of impact toughness. The stigma of ceramics lacking toughness persists.

In the meantime, Greenleaf's whisker-reinforced ceramics and XSYTIN®-1 have been successfully implemented in heavily interrupted cuts (weld-overlay Stellite-6 with a 50% interruption in conical valves, for example) and milling in most of the materials addressed in this guide.

The main difference in applying ceramics and WC-Co tools in interrupted cuts comes from the fact that ceramics, being more brittle, do not tolerate thermal shock as well as carbide. Large variation in temperature of the inserts results in accelerated crack growth that leads to weakening of the tool and irregular wear. Additionally, continuous cuts differ from strongly interrupted cuts in that the heat builds up from the moment the tool enters the material and reaches an equilibrium, with a constant amount of heat remaining in the cutting zone and plasticizing the material ahead of the cut. Interrupted cuts, provided they are executed at the same cutting speed as continuous cuts, therefore result in the heat never reaching the necessary levels for optimal plasticization.

To tackle both thermal shock and insufficient plasticization, cutting speed must be increased when interruptions are present.

The degree to which the speed is increased, however, is different for turning and milling, and for whisker-reinforced ceramics and XSYTIN®-1.

Interrupted Turning

Whisker-Reinforced Ceramics

For whisker-reinforced ceramics, it is recommended to increase the speed sufficiently to compensate exactly for the missing material. That is to say, if 50% of the material is taken away by voids or interruptions at the surface, 50% of the surface remains in contact with the tool compared to an uninterrupted part and the cutting speed should be doubled. If 30% of the material is missing, then RPM should be calculated as if the circumference/diameter is actually 70% of what it is, resulting in $1/0.7 = 1.428 \sim 43\%$ higher RPM, etc. To further increase the amount of heat that remains in the material, feed rates should be decreased from where they would be for continuous cuts.

To protect the edge from impact and redirect more of the incident cutting force into the insert (loading it more in compression instead of bending) heavier edge preparations are recommended for whisker-reinforced ceramics in interrupted cuts – T2A or T7A.

Figure 72a – Heavier Edge Preparations for Interrupted Cuts

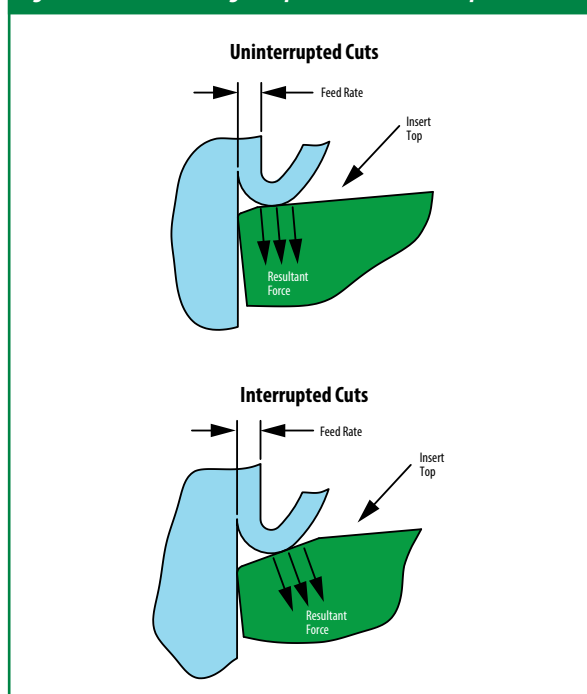

Feed rates should be kept below the width of the land – less than 0.0059 IPR (0.15mm/rev) for T2A and less than 0.0138 IPR (0.35mm/rev) for T7A.

XSYTIN®-1

The peak temperature reached by XSYTIN®-1 is of higher importance than the average temperature in the cutting zone (for plasticization) and since XSYTIN®-1 is significantly more resistant to mechanical impact and thermal shock than whisker-reinforced ceramics, cutting speed should not be increased as much. In some cases, wear is actually improved when XSYTIN®-1 has the opportunity to cool down before reentering the material. As a rule of thumb, increase cutting speed by X% when X% of material is missing.

Because of the much higher edge strength of XSYTIN®-1, sharper edges are actually preferred in interrupted cuts, to reduce the overall magnitude of the impact, so the recommended edge preparation for severe interruptions and milling is A-hone. No feed reduction is generally required in interrupted turning for XSYTIN®-1.

Milling

Since milling is essentially a special case of interrupted turning one would think that the adjustments in cutting conditions are similar, but they aren't. This is due to the fact that the chip thickness evolves for each sweep of the insert in the milling cutter through the machined surface.

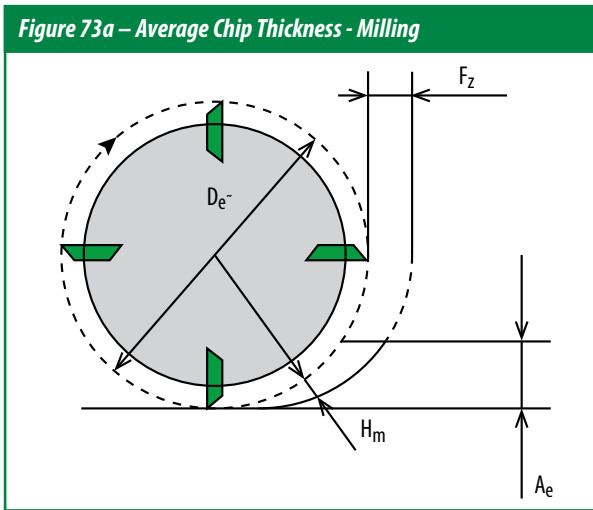

For round inserts, average chip thickness H_m is a function of

1. Effective diameter, D_{eff}
2. Width of cut, A_e
3. Radius of the insert, R
4. Depth of cut, A_p
5. Feed per tooth, F_z

$$H_m \approx F_z \sin(\cos^{-1}(1 - A_p/R)) \sqrt{A_e/D_{eff}}$$

For straight-edged inserts, average chip thickness H_m is a function of

1. Effective diameter, D_{eff}
2. Width of cut, A_e
3. Lead angle, K_r
4. Feed per tooth, F_z

$$H_m \approx F_z \sin(K_r) \sqrt{A_e/D_{eff}}$$

Material-Independent Guidelines

Many considerations in ceramic milling are similar to those in turning.

- Mechanical stress variation needs to be kept to a minimum, so that
 - Entry/exit into the material should be soft, and kept to an absolute minimum – staying in contact with the workpiece will drastically extend tool life
 - Tool path radii need to be as large as the workpiece would allow, with absolutely no sharp points
 - Ramping in is always significantly better than plunging or a straight entry
 - The shortest possible arbors are to be used to reduce deflection and vibration of the tool
 - The direction and magnitude of cutting forces need to be accounted for with respect to the rigidity of the workpiece and fixture, again, to reduce deflection and vibration
- Heat distribution should be kept constant as much as possible, so that
 - Chip thickness is kept constant for varying width of cut (engagement) and depth of cut
 - Speed is increased when engagement drops below 65%
 - Staying in contact with the workpiece is preferred to exit and re-entry

The importance of the tool path cannot be overstated. The programming makes or breaks a ceramic milling application.

Additionally:

- The machine needs to have sufficient power for the dramatic increase in metal removal (and associated increase in spindle loads), particularly in heavy milling applications with XSYTIN®-1
- The machine needs to have a sufficiently high spindle speed, because 3280 SFM (1000m/min) with an effective diameter of 0.630" (16mm) translates into ~20,000 RPM
- The machine needs to be closed. Molten chips leaving at 3280 SFM (1000m/min) can be a safety hazard.

Material-Specific Guidelines

The recommended speed and chip thickness for 65-100% engagement are shown in the table below.

When engagement is lower than 65%, speed should be increased further.

Note that these are the recommended starting cutting conditions. You may need to adjust both speed and chip thickness up or down to optimize the process for your unique machining environment.

Speed and Chip Thickness Recommendations — Milling

	HRC	Cutting Speed: V_c [SFM] Average Chip Thickness: H_m [inch]			Cutting Speed: V_c [m/min] Average Chip Thickness: H_m [mm]				
		WG-300® WG-600® WG-700™	XSYTIN®-1	GSN100™	WG-300® WG-600® WG-700™	XSYTIN®-1	GSN100™		
		V_c	H_m	V_c	H_m	V_c	H_m		
S1: Corrosion-Resistant HRSA Inconel 625, Incoloy 825, Hastelloy, Monel		V_c : 4600	H_m : 0.003	3600	0.0045	1400	0.08	1100	0.12
		H_m : 0.003	0.0045						
S2: High-Strength HRSA (Solution-Treated^[3]) Low γ'^[4] S2 (Solution-Treated and Aged) Inconel 706, Inconel 718, Inconel 725 High γ' S2 (Solution-Treated and Aged) IN100, Udimet 720, Waspaloy, C1023, Rene 88, N-18	20	V_c : 3950	H_m : 0.003	3000	0.0045	1200	0.08	920	0.12
		H_m : 0.003	0.0045						
	40-45	V_c : 3450	H_m : 0.0015	2600	0.0025	1050	0.04	800	0.06
		H_m : 0.0015	0.0025						
	40-50	V_c : 2600	H_m : 0.001	1950	0.002	800	0.03	600	0.05
		H_m : 0.001	0.002						
S3: Wear-Resistant HRSA Stellite, Eutalloy, Metco, Wall Colmonoy, Weartech	20 ^[5]	V_c : 3950	H_m : 0.0015	2600	0.0025	1200	0.04	800	0.06
		H_m : 0.0015	0.0025						
	62	V_c : 1950	H_m : 0.001	1650	0.001	600	0.02	500	0.03
		H_m : 0.001	0.001						
H1: Carbon and Alloyed Steel All 4-digit AISI-SAE grades: 1010, 1060, 4140, 2550, 2350, etc.	40	V_c : 1500	H_m : 0.003	1050	0.0045	450	0.08	320	0.12
		H_m : 0.003	0.0045						
	60	V_c : 650	H_m : 0.002	450	0.0025	200	0.05	140	0.065
		H_m : 0.002	0.0025						
H3: Tool Steel D2, M4, S7, A2, etc.	45	V_c : 1300	H_m : 0.003	900	0.0045	400	0.08	280	0.12
		H_m : 0.003	0.0045						
	65	V_c : 400	H_m : 0.0015	300	0.0025	120	0.04	85	0.06
		H_m : 0.0015	0.0025						
H4: Nitrided and/or Carburized Steel 32CrMoV13, M50, M50NiL, M2, Pyrowear 675, Nitralloy	64	V_c : 400	H_m : 0.0015	300	0.0025	120	0.04	85	0.06
		H_m : 0.0015	0.0025						
K1: Lamellar (Grey) Cast Iron GG15, GG25, GG35 (EN-GJL-150, EN-GJL-250, EN-GJL-350)		V_c : 3950	H_m : 0.0045	3950	0.0045	1200	0.12	1200	0.12
		H_m : 0.0045	0.0045						
K2^[6]: Nodular Cast Iron GGG40 – GGG80 (EN-GJS-400 – EN-GJS-800)		V_c : 2950	H_m : 0.003	2950	0.003	900	0.08	900	0.08
		H_m : 0.003	0.003						
K3: Compacted Graphite Iron (CGI) EN-GJV-300 – EN-GJV-500		V_c : 2450	H_m : 0.003	2450	0.003	750	0.08	750	0.08
		H_m : 0.003	0.003						

Table continued

^[3] Solution Treated condition - most alloying elements are in solid solution, strength and hardness are low

^[4] Solution Treated and Aged condition - secondary phases have been precipitated. γ' : Ni, Ti & Ni, Al, so alloys with lower Al and Ti content (like Inconel 718) have less γ' and alloys with more Al and Ti (like IN100) have more γ' . The heat treatment (particularly solutioning temperature and aging temperature and time) also affect γ' fraction.

^[5] Where two sets of values are shown for different hardness, extrapolate cutting speed and chip thickness linearly to obtain starting cutting data for the material machined.

Speed and Chip Thickness Recommendations — Milling (Continued)

	HRC		Cutting Speed: V _c [SFM] Average Chip Thickness: H _m [inch]			Cutting Speed: V _c [m/min] Average Chip Thickness: H _m [mm]		
			WG-300® WG-600® WG-700™	XSYTIN®-1	GSN100™	WG-300® WG-600® WG-700™	XSYTIN®-1	GSN100™
			V _c	H _m	V _c	H _m	V _c	H _m
K4: White Cast Iron Ni-Hard, EN-GJN-HV350 – EN-GJN-HV600	60	V _c	400	300		120	85	
		H _m	0.0015	0.0025		0.04	0.06	
K5: Austempered Ductile Iron (ADI) EN-GJS-800 – EN-GJS-1400		V _c		1950			600	
		H _m		0.0035			0.09	
K6: Nitrided and/or Carburized Cast Iron K1 and K2 are commonly used as the parent material	64	V _c	400	300		120	85	
		H _m	0.0015	0.0025		0.04	0.06	
M1: Austenitic Stainless Steel 304, 316, 301, 201, 202, 205, etc.		V _c	3300			1000		
		H _m	0.0025			0.06		
M2: Martensitic Stainless Steel 416, 410, 420, 431, etc.	50	V _c	1000			300		
		H _m	0.0025			0.06		
M3: Super-Austenitic Stainless Steel S31266, 904L, N08031, S34565, 1.4588, etc.		V _c	3300			1000		
		H _m	0.0025			0.06		
M4: Duplex Stainless Steel F51 (1.4462), F53 (1.4410), F55 (1.4501), 255 (1.4507), CD3MN		V _c	3300			1000		
		H _m	0.0025			0.06		
M5: Precipitation-Hardening Stainless Steel A286, PH14-8Mo, PH15-7Mo, 15-5PH, 15-7PH, 17-4PH, 17-7PH	40	V _c	3300			1000		
		H _m	0.0025			0.06		

Heat-Resistant Super Alloys (S)

Only round inserts should be used, with softer materials benefitting from the more positive cutting of RPGN.

Climb/down mill for the best wear and tool life below 50 HRC, and combine down and up milling for the best wear and tool life above 50 HRC. Excessive wear leads to chips welding to the tool. The extreme strain that the workpiece material experiences in ceramic milling means that the surface is generally quite rough and should be finished with WC-Co tools.

High-Carbon Martensite (H1, H3<60 HRC, M2)

Below 60 HRC – XSYTIN®-1, climb/down milling. Above 60 HRC – WG-300®/WG-600®, conventional/up milling.

Carbides and Nitrides (H3>60HRC, H4, K4, K6)

Only round inserts should be used. WG-300®/WG-600®, conventional/up milling.

ADI (K5)

Round and straight-edged inserts in XSYTIN®-1 can be used with T2, A, or T2A edge preparations.

Grey, Nodular, and Vermicular Cast Iron (K1, K2, K3)

Round and straight-edged inserts in GSN100™ or XSYTIN®-1 can be used with T2 or T2A edge preparations.

Low-Carbon Stainless Steel (M1, M2 (low-carbon), M3, M4, M5)

Only round inserts in WG-600® or WG-300® with the T1A edge preparation should be used. Negative inserts will withstand the high cutting forces better and will generally perform better than positive inserts, despite the very high ductility of low-carbon stainless steels.

Coolant

Coolant in interrupted cuts only exacerbates thermal shock and causes cracks in the cutting tool to grow faster, drastically reducing tool life and increasing the likelihood of irregular wear.

Coolant should NOT be used in strongly interrupted cuts or milling with ceramics.

Extended Material Guide

Heat-Resistant Super Alloys (S)

Corrosion-Resistant HRSA (S1)

Parts intended for service in corrosive environments are rarely heat treated to the same Ultimate Tensile Strength (UTS) and hardness as, for example, rotating components in an aircraft engine, though the same alloys (from the perspective of chemical composition, most notably Inconel 718) have been used in both types of applications. The main difference between the two, then, is the microstructure resulting from the heat treatment.

S1 alloys are generally Ni-based, tough (large grain size), and enter service without a solutioning and aging treatment, relying on (coarse) primary precipitates for high-temperature strength. Many alloying elements are not bound in any ceramic or intermetallic species and are readily available to form passivating layers or regions, preventing the corrosive agents from penetrating deeper into the material. The alloying elements also provide solid solution strengthening.

With a few exceptions, S1 alloys contain less Ti, Al, Nb, or V and more Fe than S2 alloys, because high-temperature strength is less of a priority and (especially through inclusion of more Fe) the cost of the alloy can then be made significantly lower.

S1 alloys are rarely forged and more often cast, or wrought in ways that do not significantly affect their grain orientation or internal stresses. Some S1 alloys (most notably Inconel 625) can be deposited onto other base materials by means of welding, laser-sintering, etc. to provide a corrosion- and heat-resistant interface without the need for manufacturing whole parts out of a nickel-based material.

High-Strength HRSA (S2)

The main design criteria for S2 alloys are ultimate tensile strength, stress rupture strength, resistance to creep, resistance to fatigue crack growth, and resistance to oxidation at high temperatures. Most alloys in this sub-group contain some fraction of precipitates and a higher quantity of refractory metals which raise the overall melting temperature and form very stable carbides. All alloys in the S2 group exploit what's known as the yield strength anomaly where, because of the precipitation strengthening, the yield strength of the alloy increases (or remains constant) with increasing temperature until a certain maximum.

The primary mechanism by which the majority of S2 alloys attain most of their high-temperature strength is precipitation hardening. Where the austenitic face-centered-cubic phase of nickel and cobalt are commonly denoted with γ , the (beneficial) precipitate phases are denoted with γ' (gamma prime, or g') for Ni_3Ti , Ni_3Al , Co_3Ti , Co_3Ta , and γ'' (gamma double-prime, or g'') for Ni_3Nb and Ni_3V . The average grain size of the matrix, the fraction of g' and g'' , their size, and their distribution in the matrix to a large extent determine the hardness and high-temperature UTS of the resulting part. Following solution treatment, S2 alloys undergo aging, which, in the simplest of terms, raises the temperature sufficiently and for an appropriate period of time to allow just enough mobility of atoms for precipitates to form. Along with g' and g'' this results in the formation of intergranular carbides. The remainder of the alloying elements in S2 alloys contribute in varying degrees to the formation of inter- and intragranular carbides, resistance to oxidation, and, crucially, stabilizing g' and g'' (retardation of

precipitation kinetics) because both phases are metastable and transform into non-desirable TCP phases when exposed to exceedingly high temperatures for extended periods of time, unfavorably altering the mechanical properties of the material.

The same Ni-based alloy can be heat-treated to have different mechanical properties – optimizing tensile strength, stress-rupture strength, creep resistance, and other properties as desired. A higher quantity of precipitates invariably raises the hardness, however, so that stationary Ni-based components that are treated for impact toughness tend to be softer, more ductile, with larger grain size, and rotating components that are treated for tensile strength are harder, less ductile, and have lower grain size. Ni-based S2 parts are either cast (with directional solidification being the dominant route for turbine blades) forged from a VIM-VAR (Vacuum Induction Melting, Vacuum Arc Remelting) or HIP (Hot Isostatic Pressing – a method of compacting atomized powder to have better control of grain size and homogeneity) billet, rolled, or printed prior to heat-treatment and machining.

Co-based S2 alloys are less common than their Ni-based counterparts because g' in Co is less stable at high temperatures, giving Ni-based alloys an advantage in strength-demanding high-temperature applications. However, carbides in Co-based alloys are more stable at temperatures exceeding 900C and so, in environments that do not require as much strength but require resistance to corrosion at very high temperatures Co-based alloys prevail. These are typically stationary components in gas turbines, and elements in and around combustion chambers. Co-based S2 alloys are cast and rarely aged before machining.

Wear-Resistant HRSA (S3)

These alloys are designed to have resistance to abrasive wear and galling at higher temperatures. Strength is then of lower importance and hardness, chemical stability, and passivating layers take center stage. Because of the higher stability of carbides in a cobalt matrix at high temperatures, cast S3 alloys are frequently cobalt-based. Many proprietary formulations for Ni- and Co-based wear-resistant alloys exist, with the most common denominator being a high fraction of Cr, Si, W, V, Mo, etc. carbides, nitrides, oxides, and borides. When not cast, they are applied to the base material through additive manufacturing. While the matrix of an S3 alloy remains ductile, the coarse secondary phases are hard and brittle, resulting in an alloy that behaves not unlike a grinding wheel when machined.

If the hardness and size/fraction of the secondary phases are too high, it's possible that the material is not addressable with ceramics and can only be machined with CBN or processed through grinding.

Hardened steel (H)

Carbon and Alloyed Hardened Steel (H1)

These steels are characterized by relatively low alloying content and a microstructure of martensite and ferrite. Depending on the heat treatment (austenitizing temperature, quench procedure, etc.) the hardness can vary considerably. The higher the martensite content, the higher the dislocation density and the higher the strength and hardness. Hardness and ductility here are inversely related – higher hardness corresponds with lower ductility.

Maraging Steel (H2)

Maraging steels (martensitic + aging) are a class of duplex-hardening ultra-high-strength steels that obtain their properties through a complex heat treatment process that increases the strength of a lath martensitic matrix with the precipitation of secondary phases – most commonly carbides. Maraging steels have high tensile strength, high hardness, and high toughness. Unlike in H1 steels, higher hardness in maraging steels does not correlate with lower ductility.

Tool Steel (H3)

Tool steels are so called because of their suitability for use as tools. Their high strength, hardness, and resistance to abrasion are a result of plate martensite and very hard carbides, predominantly of Cr, W, V, and Mo. Higher alloying content and carbide fraction is linked directly to higher hot-hardness, with High-Speed Steels (HSS) containing a significantly higher fraction of alloying elements. H3 steels are quenched and tempered, reaching 66HRC in hardness. The inverse correlation between hardness and ductility is definitely a property of H3 steels, with brittle intergranular fracture as the primary failure mode for the grades with a higher quantity of carbides.

Nitrided and/or Carburized Steel (H4)

Most steels can be surface-hardened through various means, with diffusion of nitrogen and carbon having the most pronounced effect on resistance to surface stresses and abrasion. Steels designed to be nitrided or carburized are typically hardened through conventional means prior to surface treatment and are known as duplex-hardening. The formation of carbides and nitrides in the layers of the materials adjacent to the surface introduces internal compressive stresses and raises the overall hardness. The nature of the nitriding or carburizing process determines the hardness of the compound layer and the depth of the diffusion zone. Mechanical properties of the material vary with varying carbide and nitride fraction from least ductile at the surface to most ductile past the diffusion zone.

Cast Iron (K)

Lamellar Cast Iron (K1)

Lamellar cast iron, also known as grey cast iron, has graphite in the shape of flakes with sharp, point-like ends, which act as stress concentrators and sites for crack initiation, making it brittle and rather weak in tension or shear. Also because of the shape of the graphite, grey cast iron is excellent at conducting heat and converting mechanical energy into heat – making it a great material for use in dampening. A useful side effect is that nodular and grey cast irons can be told apart by whether or not the part ‘rings’ – grey cast iron will sound dull after being struck while nodular cast iron will audibly ring.

Nodular Cast Iron (K2)

Commonly through the addition of magnesium, graphite takes the shape of spherical nodules, serving to inhibit crack nucleation and improve the mechanical properties but hindering heat transfer. Also referred to as spheroidal graphite iron or ductile cast iron, owing to the higher ductility compared to grey cast iron.

Compacted Graphite Iron (K3)

Also known as Vermicular Graphite Iron, compacted graphite iron (or CGI) is a cast iron that follows a slightly different processing route and the graphite takes the shape of clusters of connected nodules with rounded ends, combining the best of the properties of lamellar and nodular cast irons.

White Cast Iron (K4)

White cast iron is a type of cast iron where most of the carbon forms carbides and cementite in a predominantly pearlitic or martensitic matrix. As a result of the high fraction of cementite and carbides white cast iron is extremely hard and brittle, with good compressive strength and excellent resistance to abrasion.

Austempered Ductile Iron (K5)

ADI is ductile (nodular) cast iron that has been alloyed and heat-treated to convert the matrix to ausferrite – acicular ferrite in an austenitic matrix, improving the tensile strength and ductility of nodular cast iron in a bid to replace structural steel at a lower cost.

Nitrided and/or Carburized Cast Iron (K6)

In a similar fashion to steel, cast iron can be case-hardened through the diffusion of nitrogen and/or carbon in the surface layers, forming nitrides and carbides along grain boundaries. This raises the hardness, compressive stresses, and generally imparts more resistance to abrasion to the affected layer of material without compromising the material properties of the core.

Stainless Steel (M)

Austenitic Stainless Steel (M1)

Austenitic stainless steel is probably the most common and widely used class of stainless steels. It has acceptable strength at slightly elevated temperatures, excellent corrosion resistance and ductility, and is easy to produce, requiring no special heat treatments. The austenite is stabilized through addition of nickel, manganese, and/or nitrogen, with nickel improving toughness and ductility and manganese improving strength at the expense of ductility.

Martensitic Stainless Steel (M2)

High-carbon martensitic stainless steel has the potential to be treated to the highest hardness (and also to be the most brittle) of all the stainless steels. Low-carbon martensitic stainless steels with the addition of nickel feature the same type of lath martensite that serves as the matrix in maraging steels (H2), which is significantly more ductile than plate martensite, despite the strength and hardness.

Super-Austenitic Stainless Steel (M3)

M3 alloys are austenitic with a higher volume of alloying elements (most notably nickel, molybdenum, and nitrogen) to increase corrosion resistance (commonly chloride pitting and crevice corrosion). They have higher strength than regular austenitic grades, comparable to that of duplex stainless steel. Higher nickel and chrome content are also responsible for excellent toughness and ductility.

Duplex Stainless Steel (M4)

Duplex stainless steels are so called because they combine two phases of iron at room temperature – approximately 50% ferrite and 50% austenite in a layered structure. Their resistance to corrosion is similar to that of austenitic stainless steels but they have considerably higher strength. Despite the higher strength, duplex stainless steel is very ductile even at high strain rates.

Precipitation-Hardening Stainless Steel (M5)

Precipitation-Hardening (PH) stainless steels are a class of stainless steels that can be austenitic, martensitic, or a mix thereof in microstructure. Following solution treatment M5 alloys are aged to form Ni_3Cu , ordered Ni_3Ti and Ni_3Al γ' carbides, and some less useful (Laves, $Ni_3(Al,Ti)$, etc.) phases. These finely dispersed phases inhibit the movement of dislocations, raising the strength of the alloy. Coarsening of the precipitates as a result of overaging lowers the resulting strength because dislocations can then bypass them. The martensite in PH stainless steels is always lath martensite, lending this class of alloys ductility and toughness. Fully austenitic M5 alloys are, nevertheless, more ductile and able to deform plastically without failure to greater strains than their martensitic counterparts. The corrosion resistance of M5 alloys is comparable to that of austenitic stainless steels.

